

Quick Start Guide

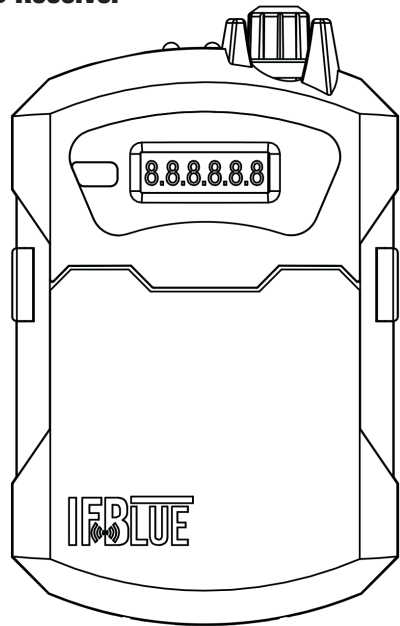

IFBR1C
UHF Multi-Frequency Belt-Pack IFB Receiver
IFBR1C, IFBR1C-941, IFBR1C-VHF



Fill in for your records:

Serial Number:

Purchase Date:

This guide is intended to assist with initial setup and operation of your IFBR1C product.

For a detailed user manual, download the most current version at:

www.IFBlue.com

IFBR1C Features

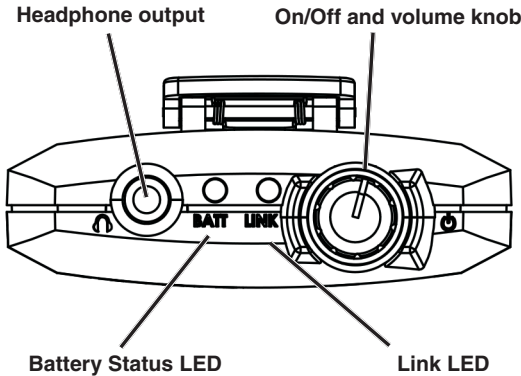

On/Off and Volume Knob

Turns unit on or off and controls headphone audio level. When the IFBR1C is first turned on, the firmware version will display briefly.



Battery Status LED

When the battery status LED glows green, the batteries are charged. The color changes to red to warn that the batteries are low. When the LED begins to *blink* red, only a few minutes remain.

The exact point at which the LED turns red will vary with battery brand and condition, temperature and power consumption. The LED is intended to simply catch your attention, not to be an exact indicator of remaining time.

NOTE: The LCD will also alert when the battery is critically low.



RF Link LED

When a valid RF signal from a transmitter is received, this LED will light up blue.

Headphone Output

A 3.5 mm mini phone jack accommodates a standard mono or stereo type 3.5 mm plug. The unit will drive low or high impedance earphones. The jack is also the receiver antenna input with the earphone cord acting as the antenna. The cord length is not critical but must be at least 6 inches minimum.

USB Port

Firmware updates via IFBlue Updater Utility are made easy with the USB port in the battery compartment.

Installing the Batteries

IFBR1C functions with two (2) AA batteries; alkaline, lithium, or NiMH rechargeables (supplied). Pinch the buttons on each side of the battery door, and pull the door toward you to open. Install the batteries with the tip (positive) to the flat terminal and the bottom (negative) on the spring contacts. Select either “primary” (non-rechargeable) or “NiMH” (rechargeable) via the slide switch next to the USB connector. Press the battery door closed until you hear the retaining clasps snap.

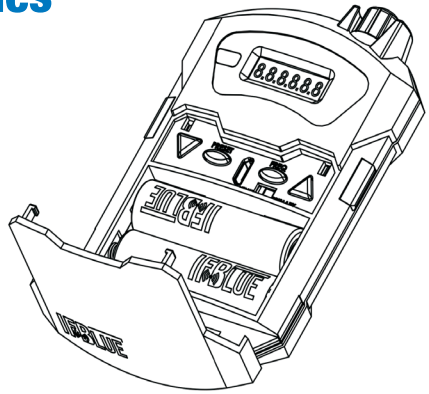

WARNING! Do NOT select NiMH (rechargeable) if you are using Lithium or Alkaline batteries; these are primary cells and can be damaged by enabling recharging. Use the NiMH only with NiMH (rechargeable) batteries.

Button Controls

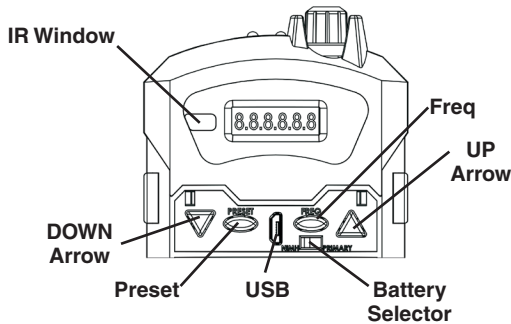

Basic Operation

Frequency Selection

Press the **FREQ** button once to select receiver frequency in MHz. The **UP** and **DOWN** arrow buttons adjust the Frequency in 1 MHz steps. Press the **FREQ** button again to select receiver frequency in kHz. The **UP** and **DOWN** arrow buttons adjust the Frequency in 25 kHz steps (VHF: 175 kHz steps).



NOTE: Holding down the **UP** or **DOWN** arrow button, as opposed to a quick press, will scroll through the frequency steps at an accelerated pace.

Preset Selection

Press the **PRESET** button to access the Preset page. Presets are displayed as:



P on the left and the current preset number (1-10) on the right **OR**



If the current preset slot is empty, an E also appears on the right. Use the **UP** and **DOWN** arrow buttons to navigate among any programmed presets, tuning the receiver to each.

NOTE: If the preset number is blinking, the receiver IS NOT currently tuned to that preset. It also indicates that the “escaped mode” is active and any preset (even empty slots) may be selected via arrows.

Programming Presets

In order to program presets, you must first get into “escaped mode.” Press and hold the **PRESET** button until the letter P blinks. Once in escaped mode, there are two options available for setting presets:

Choosing the preset slot first:

1. Press **PRESET** to display the preset page.
2. Use **UP** and **DOWN** to choose the desired slot. When navigating among the preset slots in this way, all slots are accessible, even the empty ones, and the receiver’s tuning is not affected.
3. If the desired preset slot is occupied, you can reprogram by pressing **PRESET + DOWN** to clear the slot.
4. Press **FREQ** to display the frequency, then use the **UP** and **DOWN** arrow buttons to adjust the frequency in 1 Mhz steps.
5. Press **PRESET** again to return to the preset page. You should see the slot you chose.
6. Press and hold **PRESET + UP** to store the preset. The E (if any) will disappear and the preset number will stop blinking, indicating that this slot has now been programmed.

Choosing the frequency first:

1. Press **FREQ** to display the frequency, then use the **UP** and **DOWN** arrow buttons to adjust the frequency in 25 kHz steps.
2. Press **PRESET** to display the preset page.
3. Press and hold **PRESET** until the P blinks (escaped mode). When navigating among the preset slots in this way, all slots are accessible, even the empty ones, and the receiver’s tuning is not affected. Choose the preset slot.
4. Press and hold **PRESET + UP** to program the preset. The E will disappear and the preset number will stop blinking, indicating that this slot has now been programmed with the current frequency.

Clear a Preset Selection

1. Press **PRESET** to display the preset page.
2. Press either **UP** or **DOWN** arrow buttons (tuning as you scroll) or **PRESET + UP** and **PRESET + DOWN** (selecting the preset without tuning) to select the preset number you wish to clear.

NOTE: If there is an **E** next to the preset number, the slot is already clear (empty).

3. Press and hold **PRESET + DOWN** to clear the slot. The **E** will appear and the preset number will blink, indicating the slot is now empty.

Setup Pages

Circular Navigation of Setup Pages

To access the setup pages, hold down the **PRESET** button while powering on. From there, use the **FREQ** and **PRESET** buttons to navigate circularly among the setup pages. To leave the setup pages, power off and on again.

Battery Type Selection

To access the battery selection option, hold down the **PRESET** button while powering on. The display will show *bat L* or *bat A*. Use either the **UP** or **DOWN** arrows to toggle through these two options. If installing Lithium batteries, select the *bat L* setting and then turn off the unit to save this option. If installing either Alkaline or NiMH batteries select the *bat A* setting and then turn off the unit to save this option.

Warning: Do not mix battery types. Use either two Lithium 1.5V batteries, or two Alkaline batteries, or two NiMH batteries.

Below the **Freq** button (button just left of the up-arrow) is a switch with a red cap. This switch should be in the **PRIMARY** position for Lithium and Alkaline batteries and should be in the **NiMH** position for rechargeable NiMH batteries. This red capped switch, when in the **NiMH** position, engages the charging contacts on the bottom of the unit, while this switch is in the **PRIMARY** position the charging contacts are disengaged.

Warning: Do not place the red cap switch in the NiMH position when using the other two type batteries, either Lithium or Alkaline. Any attempt to recharge Lithium or Alkaline batteries can lead to damaging both the unit and the batteries.

To recharge NiMH batteries, use the IFBlue CHSIFBR1C charger (see page 7), which can charge four IFBR1C units simultaneously.

Backlight Settings

Press the **PRESET** button while powering on the receiver. Press the **PRESET** button again to display the Backlight page. Use the **UP** and **DOWN** arrow buttons to scroll through the options:

- bL on:** Backlight always on; default setting
- bL 30:** Backlight times out after 30 seconds
- bL 5:** Backlight times out after 5 seconds

Power off the unit to exit and save the settings.

LED On/Off

Press the **PRESET** button while powering on the receiver. Press the **PRESET** button again twice to display the LED on/off page. Use the **DOWN** arrow button to turn off the LEDs and the **UP** arrow to turn on the LEDs. Power off the unit to exit and save the settings.

Locale (for 941 band receivers only)

Press the **PRESET** button while powering on the receiver. Press the **PRESET** button again until the Locale page “LC” comes up. Use the **UP** or **DOWN** arrow buttons to select the locale:

LC CA (Canada): Use with SMV/E07-941, SMQV/E07-941, HMA/E07-941, HHA/E07-941, SMWB/E07-941 and SMDWB/E07-941

LC --: Use with all other Block 941 transmitters

Power off the unit to exit and save the settings.

Firmware Update Instructions

Use the free IFBlue Updater to install firmware updates. The Updater (for both Windows and macOS), firmware update files and change notes are available from the IFBlue website:

www.IFBlue.com

- 1) Open the battery door and connect the IFBR1C to your Windows or macOS computer with a USB cable. The cable must have a micro-B male connector to mate with the USB jack in the IFBR1C.
- 2) Turn the IFBR1C on. Use the IFBlue Firmware Update Wizard to open the firmware file and install the new firmware version.

Accessories

CHSIFBR1C

IFBlue Receiver battery charging station; up to four units can be charged at once. Includes DCR5/9AU power supply and AC power cord appropriate for region.

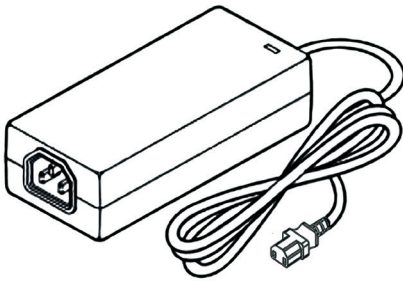
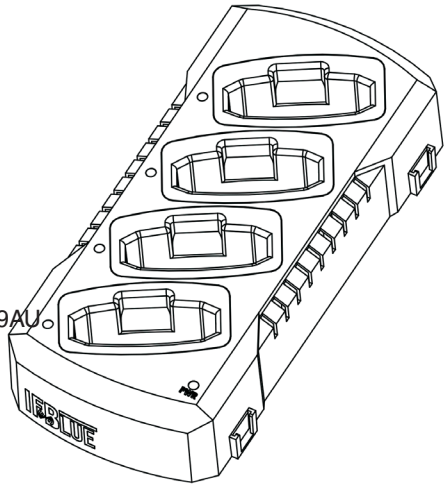

DCR5/9AU

Replacement power supply for the charging station. Includes AC power cord appropriate for region.

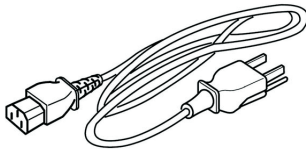



LIMITED ONE YEAR WARRANTY

The equipment is warranted for one year from date of purchase against defects in materials or workmanship provided it was purchased from an authorized dealer. This warranty does not cover equipment which has been abused or damaged by careless handling or shipping. This warranty does not apply to used or demonstrator equipment.

Should any defect develop, Lectrosonics, Inc. will, at our option, repair or replace any defective parts without charge for either parts or labor. If Lectrosonics, Inc. cannot correct the defect in your equipment, it will be replaced at no charge with a similar new item. Lectrosonics, Inc. will pay for the cost of returning your equipment to you.

This warranty applies only to items returned to Lectrosonics, Inc. or an authorized dealer, shipping costs prepaid, within one year from the date of purchase.

This Limited Warranty is governed by the laws of the State of New Mexico. It states the entire liability of Lectrosonics Inc. and the entire remedy of the purchaser for any breach of warranty as outlined above. NEITHER LECTROSONICS, INC. NOR ANYONE INVOLVED IN THE PRODUCTION OR DELIVERY OF THE EQUIPMENT SHALL BE LIABLE FOR ANY INDIRECT, SPECIAL, PUNITIVE, CONSEQUENTIAL, OR INCIDENTAL DAMAGES ARISING OUT OF THE USE OR INABILITY TO USE THIS EQUIPMENT EVEN IF LECTROSONICS, INC. HAS BEEN ADVISED OF THE POSSIBILITY OF SUCH DAMAGES. IN NO EVENT SHALL THE LIABILITY OF LECTROSONICS, INC. EXCEED THE PURCHASE PRICE OF ANY DEFECTIVE EQUIPMENT.

This warranty gives you specific legal rights. You may have additional legal rights which vary from state to state.

Designed and Distributed by Lectrosonics, Inc.

581 Laser Road NE • Rio Rancho, NM 87124 USA • www.lectrosonics.com

(505) 892-4501 • (800) 821-1121 • fax (505) 892-6243 • sales@lectrosonics.com