

# **UCR411**

## **UHF RECEIVER**

---

---

### **OPERATING INSTRUCTIONS and trouble-shooting guide**

---

---

**LECTROSONICS, INC.**

Rio Rancho, NM

[www.lectrosonics.com](http://www.lectrosonics.com)

## TABLE OF CONTENTS

DIGITAL HYBRID WIRELESS .....	2
GENERAL TECHNICAL DESCRIPTION .....	3
FRONT PANEL CONTROLS AND FUNCTIONS .....	6
LOCKING AND UNLOCKING THE UCR411 .....	6
REAR PANEL FEATURES .....	7
MENU SELECTIONS FROM MAIN WINDOW .....	8
FREQUENCY SCAN MODE .....	10
ANTENNA USE AND PLACEMENT .....	11
INSTALLATION AND OPERATING INSTRUCTIONS .....	12
UCR411 REPLACEMENT PARTS AND ACCESSORIES .....	12
TROUBLESHOOTING .....	13
SPECIFICATIONS AND FEATURES .....	14
SERVICE AND REPAIR .....	15
RETURNING UNITS FOR REPAIR .....	15
WARRANTY .....	Back cover

## DIGITAL HYBRID WIRELESS

*(US Patent Pending)*

The Lectrosonics Digital Hybrid Wireless™ uses innovative technology to combine the new advantages of digital audio with the classic advantages of analog RF transmission, thus delivering the superior sound quality of a digital system and the excellent range of an analog system. A proprietary algorithm encodes the digital audio information into an analog format which can be transmitted in a robust manner over an analog FM wireless link. The receiver employs the latest filters, RF amplifiers, mixers and detector to capture the encoded signal and a DSP recovers the original digital audio.

This digital/analog hybrid technique has some very beneficial properties. Because the information being transmitted is digitally encoded, immunity to noise is much higher than a compandor can offer. Because the encoded audio is sent in analog format, spectral and power efficiency and operating range are not compromised. Under weak RF conditions, the received signal degrades gracefully, like an analog system, delivering as much usable audio as possible at maximum range. Because the audio is not companded, no compandor artifacts are present at any audio or RF signal level. This greatly reduces the pumping and breathing problems commonly found in wireless systems with compandors.

## GENERAL TECHNICAL DESCRIPTION

The UCR411 is a portable, high performance, triple-conversion, frequency synthesized, UHF receiver fully compatible with all Lectrosynics 400 series transmitters. The RF performance is extremely stable over a very wide temperature range, making the UCR411 perfectly suited to the rough environmental conditions found in the field. The proprietary audio processing includes a digital signal processor for very low distortion and a superior signal to noise ratio.

The UCR411 features a menu-driven LCD graphic display and a three button control panel as a convenient means of viewing and altering user settings. The main window, for example, shows the pilot tone indicator, antenna diversity phase, RF level, audio level, receiver battery status and transmitter battery status. It is also possible to bypass the pilot tone from the main display window. Other display windows show operating frequency, audio output level, battery status in tenths of volts and test tone status. The frequency scan mode provides a spectrum analyzer for a graphical means of observing all signals “on the air” within the frequency range of the receiver in order to find operating frequencies that are free of interference.

### DIVERSITY RECEPTION

The UCR411 technology with SMART Diversity™ minimizes dropouts in situations where multi-path reflections can cause serious problems. The phase diversity network and PIN diode RF switches are controlled by the microprocessor using a sophisticated algorithm to use both antennas simultaneously. This design keeps the receiver compact enough for camera mounting or shoulder bag applications, yet provides effective diversity reception.

### RF FREQUENCY TRACKING FRONT-END AND MIXER

The receiver is frequency agile and can be set to operate on any one of 256 frequencies within its tuning range. To significantly reduce unwanted interference and intermodulation problems, the UCR411 has a frequency selective front-end section that tracks and tunes to the desired signal frequency and rejects or “tunes out” unwanted interfering signals. The design consists of four varactor tuned ceramic transmission line resonators controlled by the microprocessor to provide good selectivity. The low noise high current RF amplifier was designed with feedback regulation for stability and precise gain in order to handle stronger RF signals without output overload. The first mixer is of new GaAs technology that has a very high third order intercept point. This produces a robust front-end that is as selec-

tive as fixed single frequency designs and is suitable for use in close proximity to other receivers and transmitters commonly used in field production “bag” systems.

### MICROCONTROLLER, PLL AND VCO CIRCUITS

The 8-bit microprocessor is truly the “heart” of the UCR411 receiver. It monitors user command inputs from the front panel control buttons and numerous other internal signals such as RF level, audio levels, pilot tone levels and external/internal power voltages. Outputs from the microcontroller drive the LCD display and backlight, control the squelch and audio output attenuator, and operate the front-end tuning, the PLL/VCO circuits and the antenna phase switch. The UCR411 design and the advanced technology of the microprocessor control arguably set a new standard in wireless microphone development.

### IF AMPLIFIERS AND SAW FILTERS

The first IF low noise amplifier is controlled with feedback regulation and drives the first of two quartz SAW (Surface Acoustical Wave) filters. The 244 MHz SAW filters combine sharp tuning, constant group delay, wide bandwidth and excellent temperature stability, far superior to conventional LC filters. The 244 MHz first IF signal is converted to 10.7 MHz, filtered through two ceramic filters for sharp selectivity, then converted to 300 kHz in one integrated circuit.

### DIGITAL PULSE COUNTING DETECTOR

The UCR411 receiver uses an elegantly simple, yet highly effective digital pulse detector to demodulate the FM signal, rather than a conventional quadrature detector. This unusual design eliminates thermal drift, improves AM rejection, and provides very low audio distortion.

### DSP-BASED PILOT TONE

The 400 Series system design utilizes a DSP generated ultrasonic pilot tone to control the receiver audio muting (squelch). Brief delays at turn-on and turn-off eliminate thumps, pops or other transients that can occur when the power is switched on or off. The pilot tone frequency is different for each of the 256 frequencies in the tuning range of a system (frequency block.) This eliminates squelch problems in multichannel systems where a pilot tone signal can appear in the wrong receiver via intermodulation products. The DSP generated pilot tone also eliminates the need for fragile crystals allowing the receiver to survive shocks and mishandling much better than older analog-based pilot tone systems.

### SMART SQUELCH™

The UCR411 employs a sophisticated squelching system in an attempt to deliver the cleanest possible audio during marginal conditions of reception. Any squelching system faces inevitable trade-offs: squelch too much and valuable audio information may be lost, squelch too little and excessive noise may be heard; respond too rapidly and the audio sounds “choppy,” respond too sluggishly and syllables or entire words can be cut off.

The UCR411 combines several techniques to achieve an optimal balance, removing distracting noise, without the squelching action itself becoming a distraction. One of these techniques involves waiting for a word or syllable to complete before squelching. Another incorporates recent squelching history and recent signal strength, adjusting squelching behavior dynamically for the most serviceable result under variable conditions. Using these and other techniques, the UCR411 can deliver acceptable audio quality from otherwise unusable signals.

In the PILOT TONE BYPASS mode, the squelch system is disabled. Received audio remains unmuted at all times with this setting.

### SMART NOISE REDUCTION (SmartNR™)

The UCR411 has been meticulously designed using the best available low noise components and techniques. Nonetheless, the wide dynamic range of digital hybrid technology, combined with flat response to 20 kHz, makes it possible to hear the -120 dBV noise floor in the mic preamp, or the (usually) greater noise from the microphone itself. (To put this in perspective, the noise generated by the recommended 4k Ohm bias resistor of

many electret lavalier mics is -119 dBV and the noise level of the microphone’s electronics is much higher.) In order to reduce this noise and thus increase the effective dynamic range of the system, the UCR411 is equipped with a Smart Noise Reduction algorithm, which removes hiss without sacrificing high frequency response.

The Smart Noise Reduction algorithm works by attenuating only those portions of the audio signal that fit a statistical profile for randomness or “electronic hiss”. Because it isn’t simply a sophisticated variable low pass filter as in Lectrosonics’s 195 and 200 series designs, much greater transparency is thus obtained. Desired high frequency signals having some coherence such as speech sibilance and tones are not affected.

The Smart Noise Reduction algorithm has three modes, selectable from a user setup screen. When switched **OFF**, no noise reduction is performed and complete transparency is preserved. All signals presented to the transmitter’s analog front end, including any faint microphone hiss, will be faithfully reproduced at the receiver. When switched to **NORMAL**, the factory default setting, enough noise reduction is applied to remove most of the hiss from the mic preamp and some of the hiss from lavalier microphones. The noise reduction benefit is dramatic in this position, yet the degree of transparency maintained is exceptional. When switched to **FULL**, enough noise reduction is applied to remove most of the hiss from nearly any signal source of reasonable quality, assuming levels are set properly at the transmitter. This additional noise reduction comes at the cost of some transparency for low-level room noise, yet the algorithm remains undetectable under most circumstances.

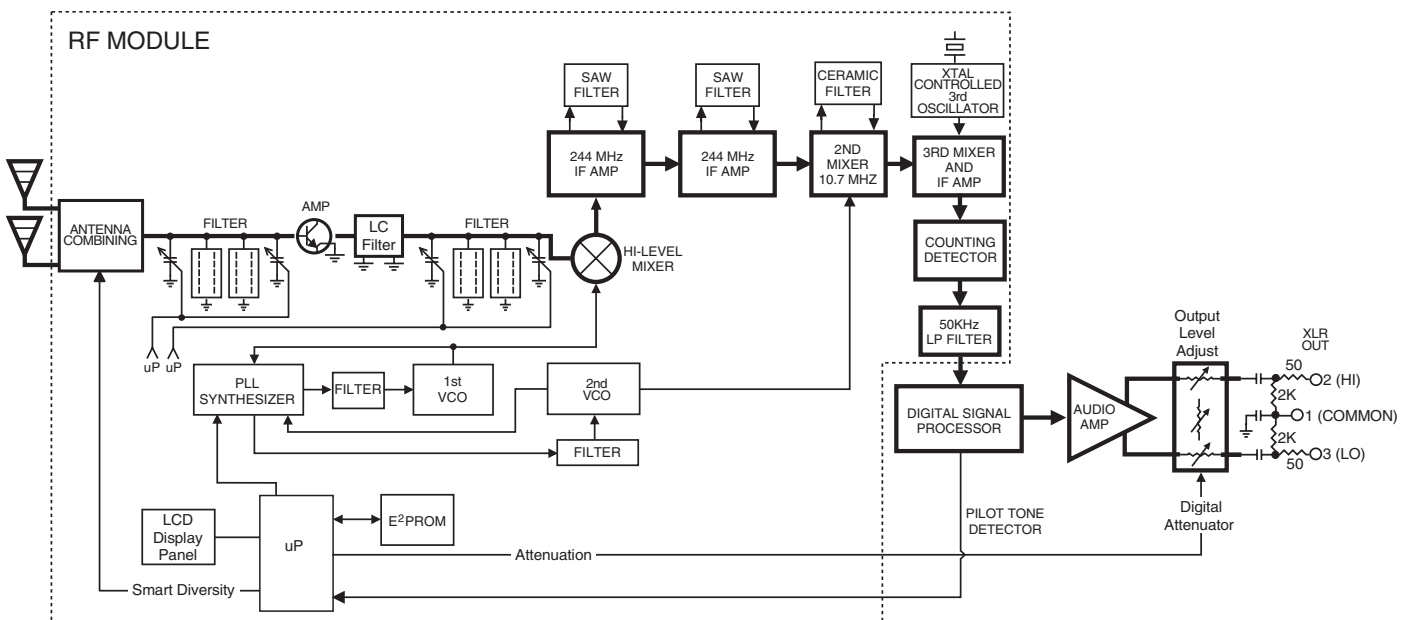

UCR411 Block Diagram

## RF-CONTROLLED DIGITAL NOISE FILTER

In addition to SmartNR, the UCR411 contains an RF sensitive variable frequency filter, which reduces high frequency response under extremely weak RF conditions. This filter does nothing until the RF signal strength drops below 3  $\mu$ V at which point it begins to roll off high frequencies. Usable audio remains unaffected, but noise-ups or “hits” occurring near the fringe of reception sound much less harsh.

## OUTPUT LEVEL ADJUST

One of several setup screens is provided for adjusting the audio output level in 1dB steps from -50 to +5dBu using the UP and DOWN buttons on the front panel.

## TEST TONE

The UCR411 provides a 1kHz audio test tone at the XLR connector for level adjustment of connected equipment. The level is adjustable from -50 to +5 dBu in 1 dB steps to allow a precise match.

## BATTERIES

The UCR411 operates on two 9V alkaline or lithium batteries. Access to the battery compartment is gained by lifting one end and turning the rear panel door. NOTE: Do not use an alkaline *and* a lithium in the same unit. Standard or “heavy duty” batteries are not recommended.

## POWER SUPPLY

The UCR411 may be operated from an external DC power source (see Specifications and Features section for allowed voltages.) The receiver has a built-in Poly-Fuse to protect the unit. This fuse resets if the power supply is disconnected for about 15 seconds. The power section also has protection circuits that prevent damage to the receiver if a positive ground power source is applied.

## LCD DISPLAY

The display has four main windows. Pressing the MENU button rotates through each of these windows.

If the battery gets low on either transmitter or receiver, a message will interrupt the display every few seconds and flash a low battery warning.

After power is turned off and back on again, the unit defaults to the main window and to the most recent frequency, audio level, transmitter battery type and locked/unlocked status settings. These settings are retained even if the batteries are removed.

## POWER UP SEQUENCE

The power-up sequence consists of four messages that appear automatically over a period of a few seconds after the power is switched on.

- 1) LOCKED or UNLOCKED status
- 2) The name LECTROSONICS
- 3) The model number and firmware revision numbers
- 4) The frequency block of operation

After these introductory messages are displayed, the main window will appear.

The UCR411 is fully operational during the power up sequence and will immediately respond to button pushes made before the automatic sequence is completed. If a valid transmitter signal is already present when the receiver is turned on, the audio output will typically be engaged somewhere in the middle of the power-up sequence, following a brief delay to allow the audio circuits to stabilize.

*(See LOCKING AND UNLOCKING THE UCR411.)*

## POWER OFF

When the power switch is moved to the OFF position the audio output is instantly muted (squelched) and the message “POWERING OFF...” is displayed briefly before switching off.

## FRONT PANEL CONTROLS AND FUNCTIONS

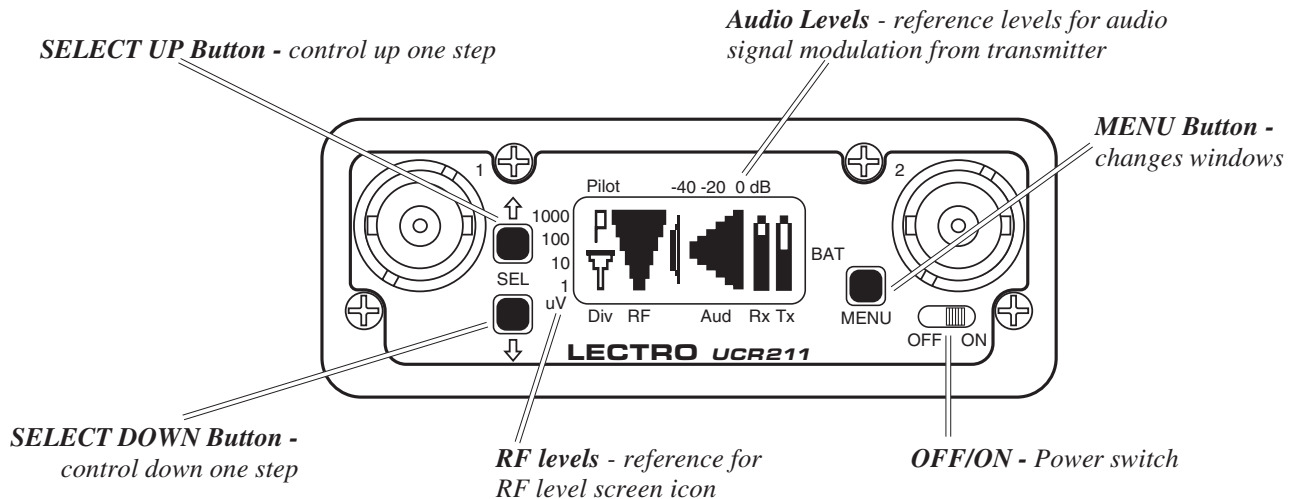

### MAIN WINDOW

 **Pilot tone indicator** - A steady “P” icon will be displayed when a pilot tone from the transmitter is present. The icon will flash if no pilot tone is detected and will change to a small “b” if the pilot tone has been bypassed. To bypass the pilot tone, hold MENU and press the UP button. Hold MENU and press UP again to restore normal pilot tone squelch.



**Antenna Phase indicator** - This icon shows antenna phase switching activity. As the antenna phase is switched, the symbol will flip vertically.



**RF level** - This icon changes in size vertically to indicate the strength of the incoming RF signal. RF levels are engraved from 1uV to 1000uV on the bezel to the left of the LCD display.



**Audio Levels** - This icon changes in size horizontally to indicate the audio level (modulation) of the signal received from the transmitter. The icon display will change to a solid rectangular block when the audio signal is being limited in the transmitter. Levels in dB are engraved into the bezel above the LCD display.



**Battery Levels** - The icon above the **Rx** symbol indicates the receiver battery condition and will flash when approximately one hour of operating time is remaining. The icon above the **Tx** symbol works in the same manner to indicate the transmitter battery condition. The **Tx** battery icon usually appears 5 to 10 seconds after the transmitter signal is acquired. When external power is being used, the **Rx** battery icon changes to look like a power plug.

### LOCKING AND UNLOCKING THE UCR411

The panel controls can be “LOCKED” to prevent accidental changes being made during operation and handling.

**To LOCK the UCR411** - Hold the MENU button down until a bar tracks horizontally across the screen and the word “LOCKED” appears. If the MENU button is released before the word “LOCKED” appears, the unit will remain UNLOCKED. When in a LOCKED state, the pilot tone bypass toggle is also defeated.

In LOCKED state, the use of the MENU and UP/DOWN buttons is limited to “view only” and attempts to change selections will result in a screen displaying the word “LOCKED.” The unit cannot be used for RF scanning when it is set in the LOCKED state.

**To UNLOCK** - Hold the MENU button down until a bar tracks horizontally across the screen and the word “UNLOCKED” appears. When the unit is UNLOCKED, all settings can be altered.

The UCR411 can be LOCKED or UNLOCKED from any of the main four windows. It cannot be switched when it is in the scanning mode or from other subordinate screens.

## REAR PANEL FEATURES

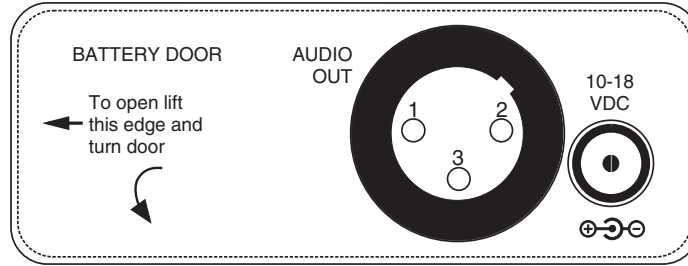

### XLR AUDIO OUTPUT JACK

This is a standard XLR configuration with pin 2 “positive” with reference to hand-held and plug-on transmitters. With lavalier microphones and belt-pack transmitters, however, phase will vary with different types of microphones (2-wire vs. 3-wire for example). The audio output is balanced but not floating, so an unbalanced signal is available using pin 1 as ground and pin 2 as signal, leaving pin 3 open.

### POWER INPUT JACK

The power input jack can accept 10-18 VDC - the center pin is positive and sleeve is ground. The input is diode protected to prevent damage if the power is applied with reversed polarity, but the unit will not work until the condition is fixed. Strain relief to avoid accidental disconnection can be provided with the included small hook and loop strip. Attach the adhesive strip side to the side of the receiver or mount with the opening end of the strip up. Place the cable in the strip and secure.



### TO REPLACE THE BATTERIES

Lift and open the bottom battery door cover with your thumb, rotate the door until it is perpendicular with the case and allow the batteries to fall out of the compartment into your hand. It is difficult to install a battery backwards. Observe the large and small holes in the battery contact pad before inserting new batteries. Insert the contact end of the battery first, making sure the contacts are aligned with the holes in the contact pad, and then swing the door closed. You will feel it snap into place when it is fully closed.

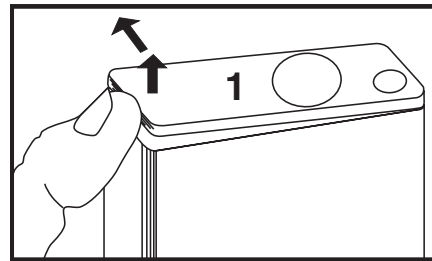

*To open the battery compartment door, push the door up and away from the case with your thumb, then swing open.*

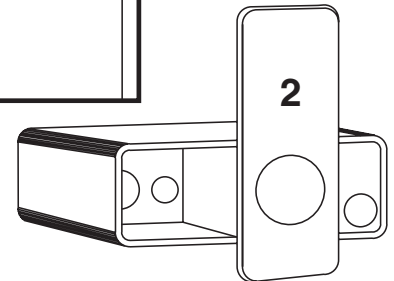

### CAUTION

Lithium batteries will expand and swell if allowed to go into a deep discharge. Be sure to remove lithium batteries as soon as possible after warnings. If lithium batteries are allowed to fully discharge while still inside the battery compartment, they will be very difficult to remove.

Stuck lithium batteries can be avoided by removing the label wrapping around the battery before use. This will allow the battery to swell but will still leave enough room in the compartment for the battery to fall out normally.

## MENU SELECTIONS FROM MAIN WINDOW

From the Main Window, you can navigate to the Frequency, Battery Level and Setup windows in a circular sequence by pressing the MENU button.

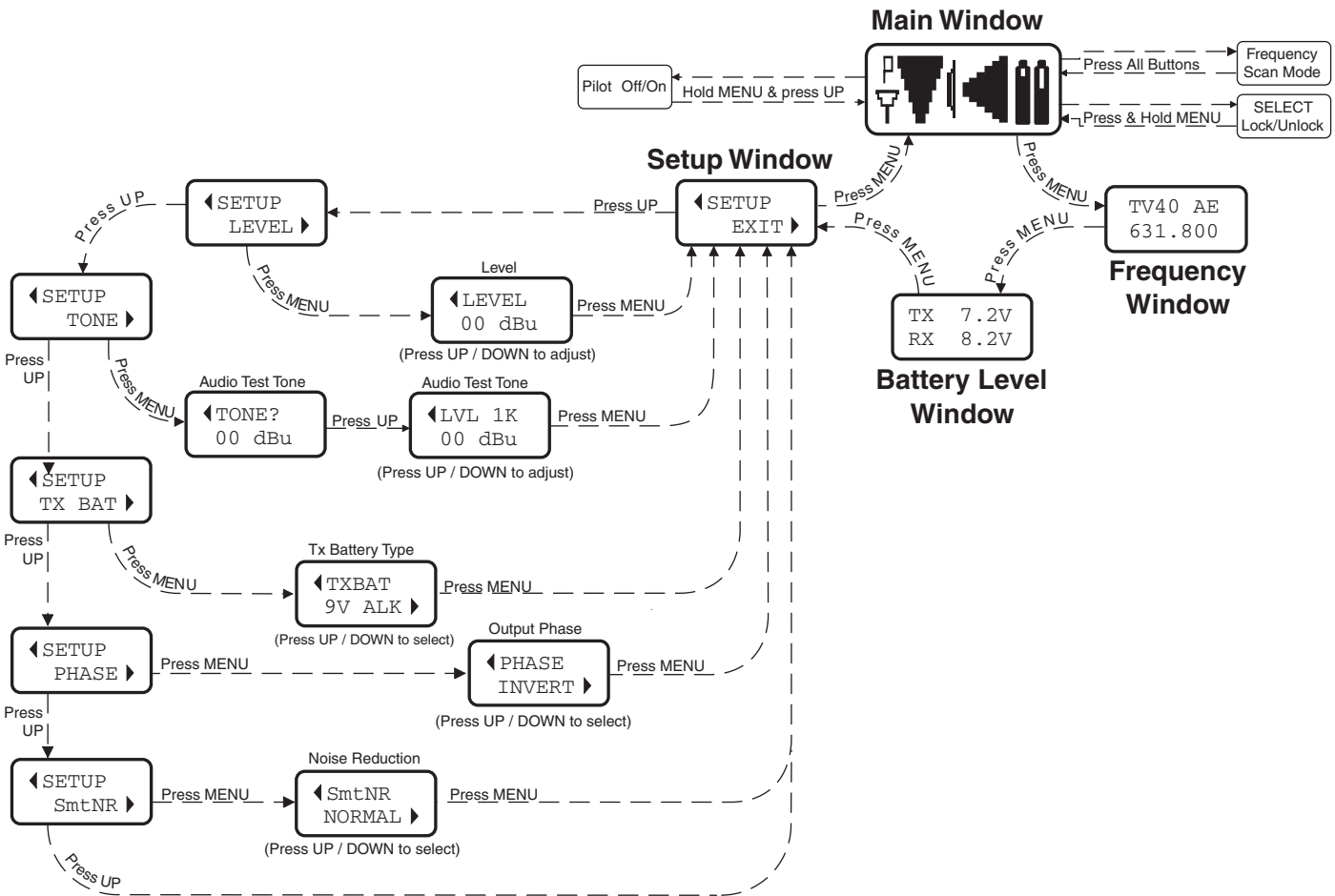

### FREQUENCY WINDOW

TV channel - which television broadcast channel this frequency falls within.

TV40 AE  
631.800

Transmitter switch settings (AE in the illustration) - these are the correct switch settings for the frequency switches on your transmitter - see your transmitter instructions.

Frequency - Press the Select Up and Select Down buttons to change the frequency of the receiver. Be certain to change the transmitter switches to match the settings shown in the upper right hand corner.

### BATTERY LEVEL WINDOW

This window shows the transmitter (TX) and receiver (RX) battery voltage in tenth volt increments. These levels will flash when the voltages drop below suggested optimum working levels. Typically, there will be about one hour operating time remaining after the indicators begin to flash. The RX voltage changes to EX when operating on external power and displays the external power source voltage. (Disclaimer: We don't guarantee 0.1 Volt accuracy.)

TX 7.2V  
RX 8.2V



## SETUP WINDOW

In the **SETUP** window, the UP and DOWN buttons scroll through a list of five possible destinations: EXIT, LEVEL, TONE, TXBAT and PHASE INVERT. Each of these destinations allows a variety of settings to customize the receiver operating parameters. Press MENU at the screen shown here to return to the main window.



The **LEVEL** setup screen shows the audio output level of the receiver in dBu. Use the UP or DOWN buttons to change the level. Range is from -50 to +5 dBu in 1dB steps. Press MENU to leave this screen.



The **TONE** setup screen enables an audio test tone at the receiver output for precise level matching with other equipment. The first screen prompts you to press the UP button to enable the tone at the receiver output jack. The next screen that appears allows the level to be adjusted in 1dB steps using the UP and DOWN buttons.

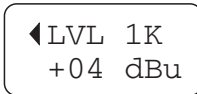
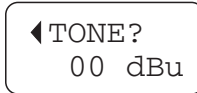

When the audio test tone is enabled, the received audio is muted and an internally generated 1kHz test tone is routed to the XLR connector. Since there is only one audio output level setting for both received audio and tone, the level set here will be retained in the receive mode (it will supersede the setting made in the LEVEL setup screen). The test tone has 1% distortion and is intended for confirmation of output levels only. To exit the test tone screen and stop the tone press the MENU button.

The **TXBAT** setup screen allows you to select the exact battery being used in the transmitter to provide more accurate battery level monitoring.

Four different types of batteries are commonly used in Lectrosonics transmitters: 9 Volt alkaline, 9 Volt lithium, AA alkaline, and AA lithium. Correctly set, this will ensure that adequate warning will be provided in advance of battery failure. Press MENU to leave this screen.

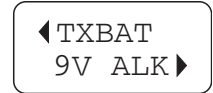

The output **PHASE** setup screen allows the audio output phase to be inverted. The UP and DOWN buttons can be used to toggle between normal and inverted phase. Press MENU to leave this screen.



The **SmtNR** setup screen places the Smart Noise Reduction algorithm in one of three modes. In the **OFF** position, no noise reduction is applied, for complete transparency. In the **NORMAL** position (factory default setting), a moderate amount of noise reduction is applied, dramatically reducing hiss with virtually no discernible side effects. In the **FULL** position, the transparency is superior to the Lectrosonics noise reduction system used for many years in the 195 and 200 series systems. Try switching between the three modes to decide what setting is correct for your application. Refer to the Smart Noise Reduction section in the GENERAL TECHNICAL DESCRIPTION chapter for more detailed information about this feature.

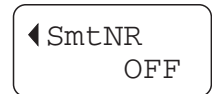
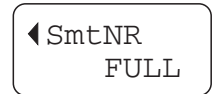
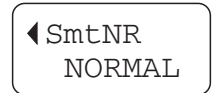

## FREQUENCY SCAN MODE

To use the integrated scanning function, press both UP/DOWN buttons and the MENU button at the same time. The display will switch to the SCAN WINDOW and start scanning immediately. Data gathered during a scan is stored until it is purposely erased or the power is turned off. Previous data will remain and subsequent scans can be made to search for additional signals or to accumulate higher peaks.

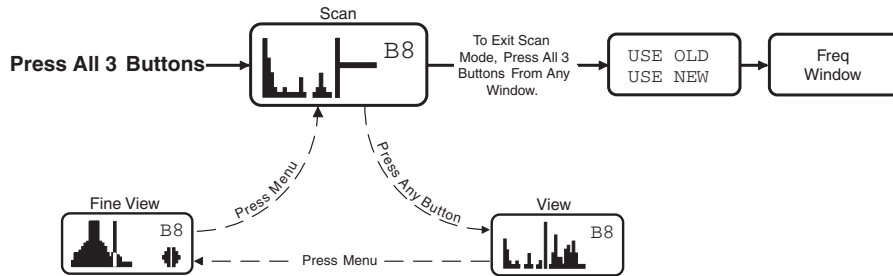

### SCAN & VIEW WINDOW ELEMENTS

**Cursor** - shows relative position of the scanner within the 25Mhz band of the receiver.

**Scan level indications** - showing relative level of RF activity across the 25MHz bandwidth of the receiver.

**Switch Settings** - shows the transmitter switch settings - will change rapidly while the unit is scanning.

**Remaining unscanned part of band.**

### FINE VIEW WINDOW ELEMENTS

**Cursor (center bar)**

**Transmitter Switch Settings**

**RF Level indicators**

**SCROLL reminders**

To stop scanning, press the MENU button once. The scanning will stop immediately, and the display will switch to the VIEW window. In this window, each vertical band of the display represents 8 frequencies (800kHz). Pressing the UP or DOWN buttons will scroll the cursor coarsely across the tuning range. The transmitter switch settings matching the frequency indicated by the cursor are shown in the upper right corner of the screen.

Spectrum data is collected only when the receiver is scanning. Successive scanning with repeated passes through the tuning range will accumulate the highest peaks encountered to aid in finding clear frequencies. To clear the scan memory without leaving scan mode, turn the power switch off and back on quickly.

Pressing the MENU button once will shift the display to the FINE VIEW window which will show an expanded portion of the spectrum around the cursor.

In the FINE VIEW window, each vertical band represents one frequency the UCR411 is capable of tuning. The upper right corner shows the transmitter switch settings for the frequency indicated by the cursor. In this screen, a vertical center bar is the cursor. Underneath the switch settings are two arrows to remind you that this is a partial picture of the spectrum and that you can scroll left or right to view the entire spectrum of the receiver by pressing the UP and DOWN buttons.

Pressing the UP button will make the display scroll left, showing higher frequencies. Pressing the DOWN button will make the display scroll right, showing lower frequencies. The cursor remains in place while the display scrolls left or right

In addition to assessing the congestion within the RF tuning range of the receiver, the scanning mode is also used to find a clear operating frequency. Scroll through the screen and find a frequency where no RF signals are present (or in the worst case, only very weak RF signals). With the cursor on this frequency, press the UP, DOWN and MENU buttons at the same time to leave the scan mode.

When leaving the scan mode, you are given the option of using the frequency the unit was on before entering the scan mode, or using the frequency just selected in the scan mode. The display shows USE OLD and USE NEW to prompt you to make a frequency selection. To accept the new frequency just selected in the scan mode, press the DOWN button for USE NEW. To return to the frequency you were using before entering the scan mode, press the UP button for USE OLD. (The MENU button defaults to USE OLD).

Once you leave the scan mode, the Frequency Window will be displayed. Set your transmitter switches to the same settings as shown on the display and your system will be ready for operation.

## ANTENNA USE AND PLACEMENT

The receiver is supplied with two straight BNC antennas. In some circumstances remote antennas such as the SNA600 or ALP700 may be useful for improving reception. Position remote antennas at least three or four feet apart and so that they are also not within 3 or 4 feet of large metal surfaces. If this is not possible, try to position the antennas so that they are as far away from the metal surface as is practical. It is also good to position the receiver so that there is a direct "line of sight" between the transmitter and the receiver antenna. In situations where the operating range is less than about 100 feet, the antenna positioning is much less critical. The antennas can also be configured with one whip mounted directly onto the panel of the receiver, and the other one mounted remotely.

Be careful about the length of cabling from antenna to receiver. Long cable runs can have serious signal loss. Lectrosonics has in-line RF amplifiers suitable for compensating for long cable runs. Contact your dealer or the factory for more information.

A wireless transmitter sends a radio signal out in all directions. This signal will often bounce off nearby walls, ceilings, etc. and a strong reflection can arrive at the receiver antenna along with the direct signal. If the direct and reflected signals are out of phase with each

other a cancellation may occur. The result would be a "dropout." A dropout sounds like either audible noise (hiss), or in severe cases, may result in a complete loss of the carrier and the sound when the transmitter is positioned in certain locations. A UHF dropout normally sounds like a very brief "hiss" or a "swishing" sound. Moving the transmitter even a few inches will change the sound of the dropout, or eliminate it. A dropout situation may be either better or worse as the crowd fills and/or leaves the room, or when the transmitter or receiver is operated in a different location.

The receiver offers a sophisticated diversity design which overcomes dropout problems in almost any situation. In the event, however, that you do encounter a dropout problem, first try moving the receiver at least 3 or 4 feet from where it was. This may alleviate the dropout problem at that location. If dropouts are still a problem, try moving the unit to an entirely different location in the room or moving the receiver in closer to the transmitter location.

Lectrosonics transmitters radiate power very efficiently, and the receivers are very sensitive. This reduces dropouts to an insignificant level. If, however, you do encounter dropouts frequently, call the factory or consult your dealer. There is probably a simple solution.

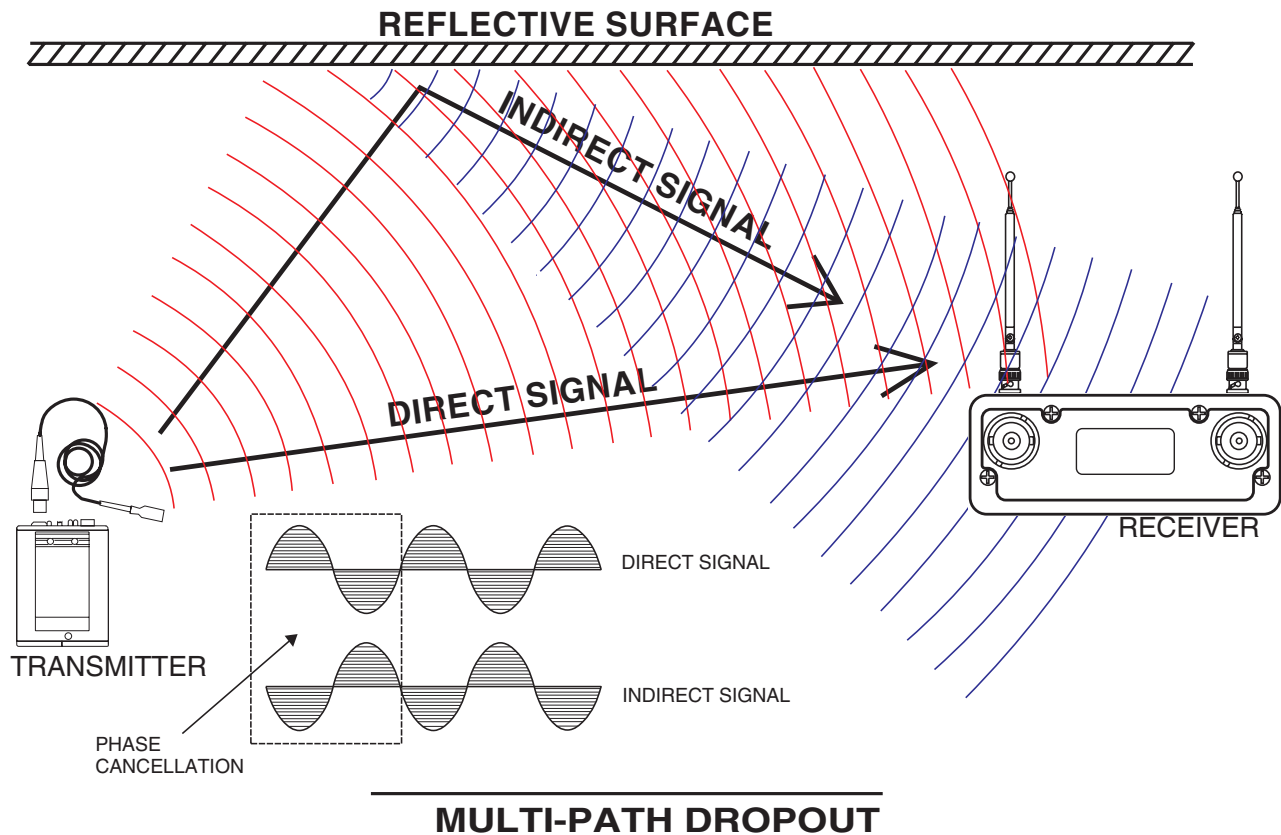

## INSTALLATION AND OPERATING INSTRUCTIONS

1. Install batteries or connect the power cord.
2. Attach the antennas.
3. Turn the unit on. Check to see that the LCD display panel activates.
4. Set the frequency to match the transmitter frequency switch setting. See page 7.
5. Turn transmitter on and verify that an RF signal is being indicated on the LCD screen. See page 6.
6. Connect the audio cable to the audio output XLR.
7. Adjust the transmitter gain. **THIS IS PERHAPS THE MOST IMPORTANT STEP IN THE SET UP PROCEDURE.** See your transmitter manual (Operating Instructions section) for details on how to adjust the transmitter gain. In general, adjust the transmitter gain so that the voice peaks will cause the audio modulation Level display on the front of the receiver and transmitter to show full modulation on the loudest peak audio levels. Normal levels should cause the audio level icon to fluctuate fully (see page 6). This will result in the best possible signal to noise ratio for the system.

*A common mistake at this point is to use the transmitter audio gain control to set the overall audio level of the entire audio system. The transmitter gain control is not a volume control and must be set independently of the overall system audio level. The transmitter gain control is only used to set the proper modulation of the transmitter. To explain it another way, it is used to match the transmitter to the type of microphone and the sound levels that will be present at that microphone. We encourage users to either disconnect the rest of the sound system or turn the sound system gain way down to prevent feedback or overload as the transmitter gain is set. That way, feedback from the sound system or overload of other equipment does not get in the way of setting the transmitter gain properly. Only after the transmitter gain control is set should the gain of the rest of the audio system be adjusted to achieve the desired sound or signal levels.*

8. Adjust the audio output level to match the required input level of the connected device (camera, mixer, recorder, etc.). Use the LEVEL or TONE setup screen under the LEVEL WINDOW menu and adjust the output level with the Up and Down buttons. The adjustment range is from -50dBu to +5dBu in 1dB steps.

The test tone output is especially useful for an exact level match. With the test tone running, adjust for the maximum desired peak level using the metering on the connected device.

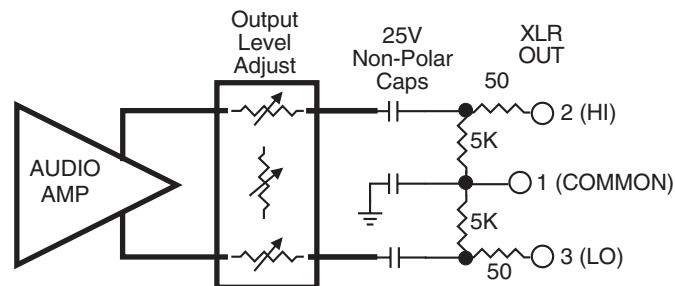

UCR411 Simplified Audio Output Circuit

## UCR411 REPLACEMENT PARTS AND ACCESSORIES

<u>Part No.</u>	<u>Description</u>
32251	Velcro mounting strips
CCMINI	Zippered, padded vinyl system pouch
CH12	AC power supply
VSR1	Thin velcro loop for power cable strain relief.
A8U	UHF marine phosphor bronze antenna - straight connector, specify block.

## TROUBLESHOOTING

---

### POWER SUPPLY AND FUSE

#### LCD display not active or lit.

- External power supply disconnected or inadequate.
- Main power supply fuse tripped. Turn the receiver off, remove the cause of the overload and turn the receiver back on.
- Wrong polarity power source. The external DC in requires POSITIVE to be on the center pin.
- Battery may be low. Try a fresh battery

---

### PILOT TONE SQUELCH

#### PILOT indicator is solid “P”, but no sound

- Audio output cable bad or disconnected.
- Audio Output level set too low. Use the built-in test tone to verify levels.

#### PILOT “P” keeps flashing when transmitter audio switch is turned on

- Pilot tone detection can take several seconds. Turn on the transmitter power (and the audio switch on some models) and wait 3 to 5 seconds for the “P” to indicate steadily.
- Transmitter and receiver not on same frequency.

#### Noise on audio and Pilot indicator is “b”.

- The pilot tone bypass has been activated. Hold MENU and press UP to reset (works only from the Main Window).

#### NOTE:

The PILOT indicator on the front panel shows as a solid “P” to indicate that the audio has been turned on at the transmitter, and that the audio output on the receiver is enabled. When the “P” is on, the audio is enabled. If the “P” is flashing the pilot tone is not detected and the audio will be muted (squelched).

When the pilot tone is bypassed, the “P” icon changes to a “b” shape.

---

### ANTENNAS AND RF SIGNAL STRENGTH

#### RF Level is weak.

- Receiver may need to be moved or reoriented.
- Antenna on transmitter may be defective or poorly connected - double check antenna on transmitter.
- Improper length of antenna, or wrong antenna on transmitter or receiver. UHF whip antennas are generally about 3 to 5 inches long. UHF helical antennas may be shorter, but are often less efficient.

#### No RF Signal

- Make certain frequency switches on transmitter match the receiver frequency setting.
- Check battery in transmitter

---

### AUDIO SIGNAL QUALITY

#### Poor signal to noise ratio

- Transmitter gain set too low
- The noise may not be in the wireless system. Turn the transmitter audio gain all the way down and see if the noise remains. If the noise remains, then turn the power off at the transmitter and see if it remains. If the noise is still present, then the problem is not in the transmitter.
- If noise is still present when the transmitter is turned off, try lowering the audio output level on the UCR411 and see if the noise lowers correspondingly. If the noise remains, the problem is not in the receiver.
- Receiver output is too low for the input of the device it is feeding. Try increasing the output level of the UCR411 and lowering the input gain on the device the UCR411 is feeding.

#### Distortion

- Transmitter input gain too high. Check and/or readjust input gain on transmitter according to the LEDs on the transmitter and then verify the setting with the audio meter in the main window.
- Audio output level too high for the device the UCR411 is feeding. Lower the output level of the UCR411.

## SPECIFICATIONS AND FEATURES

### Operating Frequencies (MHz):

Block 21:	537.600 - 563.100	Block 26:	665.600 - 691.100
Block 22:	563.200 - 588.700	Block 27:	691.200 - 716.700
Block 23:	588.800 - 607.900	Block 28:	716.800 - 742.300
and	614.100 - 614.300	Block 29:	742.400 - 767.900
Block 24:	614.400 - 639.900	Block 30:	768.000 - 793.500
Block 25:	640.000 - 665.500	Block 31:	793.600 - 805.600

### Frequency Adjustment Range:

25.5 MHz in 100kHz steps

### Receiver Type:

Triple conversion, superheterodyne, 244MHz, 10.7MHz and 300kHz

### Frequency Stability:

±0.001 %

### Front end bandwidth:

±5.5MHz @ -3dB

### Sensitivity

20 dB Sinad:	0.9 uV (-108 dBm), A weighted
60 dB Quieting:	1.12 uV (-105 dBm), A weighted

### Squelch quieting:

Greater than 100 dB

### AM rejection:

Greater than 60 dB, 2 uV to 1 Volt (Undetectable after processing)

### Modulation acceptance:

85 kHz

### Image and spurious rejection:

85dB

### Third order intercept:

+8 dBm

### Diversity method:

Phased antenna combining - SmartDiversity™

### FM Detector:

Digital Pulse Counting Detector operating at 300kHz

### Antenna inputs:

Dual BNC female, 50 Ohm impedance

### Audio outputs

**Rear Panel XLR:** Adjustable from -50dBu to +5dBu in 1 dB steps. Calibrated into a typical 10k Ohm balanced load. Can drive 600 Ohm load.

### Front Panel Controls and Indicators:

LCD control panel - menus include:

<b>Main window:</b>	Pilot tone; antenna phase, receiver battery level; transmitter battery level; audio level, RF level
<b>Frequency window:</b>	Frequency, TV channel; Transmitter switch setting
<b>Audio output level adjustment:</b>	-50dBu to +5dBu
<b>Battery level tracking:</b>	Both transmitter and receiver in 1/10th volt steps, accuracy +/- 0.2V.
<b>Scanning mode:</b>	Coarse and fine modes for RF spectrum site scanning
<b>Audio test tone:</b>	1kHz, -50dBu to +5dBu output, < 1% THD
<b>Transmitter battery type selection:</b>	9V alkaline, 9V lithium, AA alkaline, AA lithium
<b>Phase invert:</b>	Audio output phase normal or inverted
SmartNR (noise reduction):	OFF, NORMAL, FULL modes

### Audio Performance (overall system):

**Frequency Response:** 32 Hz to 20 kHz (+/- 1dB)

**THD:** 0.2% (typical)

### SNR at receiver output (dB):

SmartNR	no limiting	w/limiting
OFF	1035	1080
NORMAL	1070	1115
FULL	1085	1130

**Input Dynamic Range:** 125 dB (with full Tx limiting)

### Rear Panel Controls and features:

XLR audio output jack; External DC input; Battery compartment access

### Power Options:

**Ext DC:** Minimum 10 Volts to maximum 18 Volts DC; 1.6 W, 180 mA at 12VDC  
**Int Batt:** 9V alkaline or lithium (165 mA @ 9V, 240mA @ 6V)

### Battery Life:

**9V alkaline** 6 to 8 hours continuous, up to 12 hours intermittent  
**9V lithium** Up to 20 hours (continuous and intermittent usage are the same)

### Weight:

14 oz. with batteries

### Dimensions:

3.23" wide x 1.25" high x 4.64" deep

*Specifications subject to change without notice*

## SERVICE AND REPAIR

If your system malfunctions, you should attempt to correct or isolate the trouble before concluding that the equipment needs repair. Make sure you have followed the setup procedure and operating instructions. Check out the interconnecting cords and then go through the TROUBLESHOOTING section in the manual

We strongly recommend that you **do not** try to repair the equipment yourself and **do not** have the local repair shop attempt anything other than the simplest repair. If the repair is more complicated than a broken wire or loose connection, send the unit to the factory for repair and service. Don't attempt to adjust any controls inside the units. Once set at the factory, the various controls and trimmers do not drift with age or vibration and never require readjustment. **There are no adjustments inside that will make a malfunctioning unit start working.**

LECTROSONICS' service department is equipped and staffed to quickly repair your equipment. In warranty repairs are made at no charge in accordance with the terms of the warranty. Out of warranty repairs are charged at a modest flat rate plus parts and shipping. Since it takes almost as much time and effort to determine what is wrong as it does to make the repair, there is a charge for an exact quotation. We will be happy to quote approximate charges by phone for out of warranty repairs.

## RETURNING UNITS FOR REPAIR

You will save yourself time and trouble if you will follow the steps below:

**A.** DO NOT return equipment to the factory for repair without first contacting us by letter or by phone. We need to know the nature of the problem, the model number and the serial number of the equipment. We also need a phone number where you can be reached 8 am to 4 pm (Mountain Standard Time).

**B.** After receiving your request, we will issue you a return authorization number (R.A.). This number will help speed your repair through our receiving and repair departments. The return authorization number must be clearly shown on the outside of the shipping container.

**C.** Pack the equipment carefully and ship to us, shipping costs prepaid. If necessary, we can provide you with the proper packing materials. UPS is usually the best way to ship the units. Heavy units should be "double-boxed" for safe transport.

**D.** We also strongly recommend that you insure the equipment, since we cannot be responsible for loss of or damage to equipment that you ship. Of course, we insure the equipment when we ship it back to you.

**Mailing address:**  
Lectrosonics, Inc.  
PO Box 15900  
Rio Rancho, NM 87174  
USA

**Shipping address:**  
Lectrosonics, Inc.  
581 Laser Rd.  
Rio Rancho, NM 87124  
USA

**Telephones:**  
Regular: (505) 892-4501  
Toll Free (800) 821-1121  
FAX: (505) 892-6243

**Web:** <http://www.lectrosonics.com>

**E-mail:** [sales@lectrosonics.com](mailto:sales@lectrosonics.com)

## LIMITED ONE YEAR WARRANTY

The equipment is warranted for one year from date of purchase against defects in materials or workmanship provided it was purchased from an authorized dealer. This warranty does not cover equipment which has been abused or damaged by careless handling or shipping. This warranty does not apply to used or demonstrator equipment.

Should any defect develop, Lectrosonics, Inc. will, at our option, repair or replace any defective parts without charge for either parts or labor. If Lectrosonics, Inc. cannot correct the defect in your equipment, it will be replaced at no charge with a similar new item. Lectrosonics, Inc. will pay for the cost of returning your equipment to you.

This warranty applies only to items returned to Lectrosonics, Inc. or an authorized dealer, shipping costs prepaid, within one year from the date of purchase.

This Limited Warranty is governed by the laws of the State of New Mexico. It states the entire liability of Lectrosonics Inc. and the entire remedy of the purchaser for any breach of warranty as outlined above. NEITHER LECTROSONICS, INC. NOR ANYONE INVOLVED IN THE PRODUCTION OR DELIVERY OF THE EQUIPMENT SHALL BE LIABLE FOR ANY INDIRECT, SPECIAL, PUNITIVE, CONSEQUENTIAL, OR INCIDENTAL DAMAGES ARISING OUT OF THE USE OR INABILITY TO USE THIS EQUIPMENT EVEN IF LECTROSONICS, INC. HAS BEEN ADVISED OF THE POSSIBILITY OF SUCH DAMAGES. IN NO EVENT SHALL THE LIABILITY OF LECTROSONICS, INC. EXCEED THE PURCHASE PRICE OF ANY DEFECTIVE EQUIPMENT.

This warranty gives you specific legal rights. You may have additional legal rights which vary from state to state.

### **LECTROSONICS, INC.**

---

581 LASER ROAD  
RIO RANCHO, NM 87124 USA  
[www.lectrosonics.com](http://www.lectrosonics.com)

November 27, 2002