

Canon

PUB. DIE-0477-000B

Digital Cinema Camera

EOS C300 Mark II

Instruction Manual

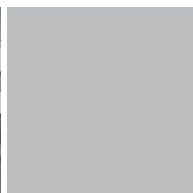

4K

2K

XF-AVC

MXF

HDMI

Important Usage Instructions

2

WARNING

To reduce the risk of fire or electric shock, do not expose this product to rain or moisture.

WARNING

To reduce the risk of fire or electric shock, do not expose this apparatus to dripping or splashing, and do not place objects filled with liquids, such as vases, on the apparatus.

WARNING

TO REDUCE THE RISK OF ELECTRIC SHOCK AND TO REDUCE ANNOYING INTERFERENCE, USE THE RECOMMENDED ACCESSORIES ONLY.

COPYRIGHT WARNING:

Unauthorized recording of copyrighted materials may infringe on the rights of copyright owners and be contrary to copyright laws.

FCC NOTICE

Digital Cinema Camera, EOS C300 Mark II Systems.

This device complies with Part 15 of the FCC Rules. Operation is subject to the following two conditions: (1) This device may not cause harmful interference, and (2) this device must accept any interference received, including interference that may cause undesired operation.

Note: This equipment has been tested and found to comply with the limits for class B digital device, pursuant to Part 15 of the FCC Rules. These limits are designed to provide reasonable protection against harmful interference in a residential installation. This equipment generates, uses and can radiate radio frequency energy and, if not installed and use in accordance with the instructions, may cause harmful interference to radio communications. However, there is no guarantee that interference will not occur in a particular installation. If this equipment does cause harmful interference to radio or television reception, which can be

determined by turning the equipment off and on, the user is encouraged to try to correct the interference by one or more of the following measures:

- Reorient or relocate the receiving antenna.
- Increase the separation between the equipment and receiver.
- Connect the equipment into an outlet on a circuit different from that to which the receiver is connected.
- Consult the dealer or an experienced radio/TV technician for help.

Use of shielded cable is required to comply with class B limits in Subpart B of Part 15 of FCC Rules.

Do not make any changes or modifications to the equipment unless otherwise specified in the manual. If such changes or modifications should be made, you could be required to stop operation of the equipment.

Canon U.S.A., Inc.
One Canon Park, Melville, NY 11747, USA
Tel No. 1-800-OK-CANON (1-800-652-2666)

The Mains plug is used as the disconnect device. The Mains plug shall remain readily operable to disconnect the plug in case of an accident.

CAUTION:

- Danger of explosion if the wrong type of batteries are attached. Use only the same type of batteries.
- Do not expose batteries or product to excessive heat such as the inside of a car under direct sunlight, fire, etc.

EOS C300 Mark II / CA-A10 / CG-A10 identification plate is located on the bottom.



CAUTION:

To reduce the risk of electric shock, do not remove cover (or back). No user-serviceable parts inside. Refer servicing to qualified service personnel.



The lightning flash with arrowhead symbol, within an equilateral triangle, is intended to alert the user to the presence of uninsulated “dangerous voltage” within the product’s enclosure, that may be of sufficient magnitude to constitute a risk of electric shock to persons.



The exclamation point, within an equilateral triangle, is intended to alert the user to the presence of important operating and maintenance (servicing) instructions in the literature accompanying the product.

Only for European Union and EEA (Norway, Iceland and Liechtenstein)



These symbols indicate that this product is not to be disposed of with your household waste, according to the WEEE Directive (2012/19/EU), the Battery Directive (2006/66/EC) and/or national legislation implementing those Directives.

■ If a chemical symbol is printed beneath the symbol shown above, in accordance with the Battery Directive, this indicates that a heavy metal (Hg = Mercury, Cd = Cadmium, Pb = Lead) is present in this battery or accumulator at a concentration above an applicable threshold specified in the Battery Directive.

This product should be handed over to a designated collection point, e.g., on an authorized one-for-one basis when you buy a new similar product or to an authorized collection site for recycling waste electrical and electronic equipment (EEE) and batteries and accumulators. Improper handling of this type of waste could have a possible impact on the environment and human health due to potentially hazardous substances that are generally associated with EEE. Your cooperation in the correct disposal of this product will contribute to the effective usage of natural resources.

For more information about the recycling of this product, please contact your local city office, waste authority, approved scheme or your household waste disposal service or visit www.canon-europe.com/weee, or www.canon-europe.com/battery.

While using the AC adapter, do not wrap it or cover it with a piece of cloth, and do not place it in confined narrow spaces.

The adapter can be used with a power supply between 100 and 240 V AC. Contact your Canon dealer for information about plug adapter for overseas use. For U.S.A. customers only: For areas where 120 V AC power is not used, you will need a special plug adapter.

For connection to a supply not in the U.S.A., the detachable power supply cord shall comply with the requirements of the country destination. For information on power supply cord, contact your Canon dealer.

For only United States

Use a UL listed, 1.8 – 3 m (6 – 10 ft.), Type SPT-2 or NTSPT-2, AWG no. 18 power supply cord, rated for 125 V 7 A, with a non-polarized NEMA 1-15P plug rated for 125 V 15 A.

Important Safety Instructions

4

In these safety instructions the word “apparatus” refers to the Canon Digital Cinema Camera EOS C300 Mark II and all its accessories.

1. Read these instructions.
2. Keep these instructions.
3. Heed all warnings.
4. Follow all instructions.
5. Do not use this apparatus near water.
6. Clean only with dry cloth.
7. Do not install near any heat sources such as radiators, heat registers, stoves, or other apparatus (including amplifiers) that produce heat.
8. Do not defeat the safety purpose of the polarized or grounding-type plug. A polarized plug has two blades with one wider than the other. A grounding type plug has two blades and a third grounding prong. The wide blade or the third prong are provided for your safety. If the provided plug does not fit into your outlet, consult an electrician for replacement of the obsolete outlet.
9. Protect the power cord from being walked on or pinched particularly at plugs, convenience receptacles, and the point where they exit from the apparatus.
10. Unplug this apparatus during lightning storms or when unused for long periods of time.
11. Refer all servicing to qualified service personnel. Servicing is required when the apparatus has been damaged in any way, such as power-supply cord or plug is damaged, liquid has been spilled or objects have fallen into the apparatus, the apparatus has been exposed to rain or moisture, does not operate normally, or has been dropped.

CAN ICES-3(B)/NMB-3(B)

Trademark Acknowledgements

- SD, SDHC and SDXC Logos are trademarks of SD-3C, LLC.
- Canon is an authorized licensee of the CFast 2.0™ trademark, which may be registered in various jurisdictions.
- Microsoft and Windows are trademarks or registered trademarks of Microsoft Corporation in the United States and/or other countries.
- Apple and Mac OS are trademarks of Apple Inc., registered in the U.S. and other countries.
- Wi-Fi is a registered trademark of the Wi-Fi Alliance.
- JavaScript is a trademark or registered trademark of Oracle Corporation, its affiliates or subsidiaries in the United States and other countries.
- HDMI, the HDMI logo and High-Definition Multimedia Interface are trademarks or registered trademarks of HDMI Licensing LLC in the United States and other countries.
- Other names and products not mentioned above may be trademarks or registered trademarks of their respective companies.
- This device incorporates exFAT technology licensed from Microsoft.
- This product is licensed under AT&T patents for the MPEG-4 standard and may be used for encoding MPEG-4 compliant video and/or decoding MPEG-4 compliant video that was encoded only (1) for a personal and noncommercial purpose or (2) by a video provider licensed under the AT&T patents to provide MPEG-4 compliant video. No license is granted or implied for any other use for MPEG-4 standard.

Highlights of the EOS C300 Mark II

The Canon Digital Cinema Camera EOS C300 Mark II has been designed to meet the demanding needs and highest expectations of industry professionals. The following are just some of the many features that will help turn your creative vision into reality.

4K Recording System with Cinema Quality

Advanced 4K-compatible Super 35mm CMOS sensor

The camera is equipped with the new Super 35mm CMOS sensor and two DIGIC DV 5 image processors so it can capture and process video at an effective pixel count of 8.85 megapixels (4096x2160) and offer a center resolution of 1,800 TV lines¹. Furthermore, thanks to Canon's high-sensitivity and low-noise technology, the camera can record at a wide range of sensitivity settings², from ISO 160 to ISO 25600. And, using the new Canon Log 2 gamma curve, you can obtain an impressively wide dynamic range equivalent to 15 stops. This level of imaging power must be seen to be believed!

¹ Varies depending on the lens used.

² The ISO speed range can be extended up to ISO 100 on one end, and ISO 102400 on the other.

Interchangeable lenses

Enjoy the freedom of using interchangeable lenses to achieve the look you want. The EOS C300 Mark II features an EF lens mount allowing you to use over 100 high-quality lenses from the Canon Cinema Lens series and EF Lens series.

4K RAW output (📖 164)

The camera has two SDI interface terminals, the MON. terminal and REC OUT terminal. You can connect an external recorder (📖 163) to either terminal to record 4K RAW data. You can also apply a LUT to video output from both terminals (📖 167). Using the LUT that meets the ACES standard, you even have the option to perform on-site color grading (📖 24). Additionally, the MON. terminal only, also supports output of onscreen displays and other assistance functions.

Multitude of options with the versatile XF-AVC format (📖 62)

The camera offers you numerous options when it comes to the video configuration of your recordings. XF-AVC Intra-frame options use H.264 Intra-frame compression to achieve maximum image quality. You can select to record 4K or 2K³ video with YCbCr 4:2:2, 10-bit color sampling, or 2K video with RGB 4:4:4, 10- or 12-bit color sampling.

³ Refers to video with a resolution of 2048x1080 or 1920x1080.

XF-AVC Long GOP options (high image quality, smaller data size) and XF-AVC Proxy options (proxy data for offline editing), on the other hand, use Long GOP compression. You can select to record 2K video with a color sampling of YCbCr 4:2:2, 10 bit or YCbCr 4:2:0, 8 bit.

The highest bit rate available is 410 Mbps using XF-AVC Intra-frame, 50 Mbps using XF-AVC Long GOP, and 24 Mbps for XF-AVC Proxy options.

Recording media

The camera records 4K and 2K video and 4-channel 16-/24-bit audio to CFast 2.0 cards, a popular type of memory card with extremely high transfer rates. The camera is equipped with two CFast card slots so you can use two CFast cards to continue recording on the other card when the one being used becomes full (relay recording) or to record the same clip simultaneously on both cards to have a backup recording (double slot recording) (📖 50). The camera has also an SD card slot. While you record primary clips on a CFast card, you can simultaneously record proxy clips –smaller files for offline editing– on an SD card (📖 111). The file format used for all clips is MXF (Material eXchange Format) so files are compatible with major non-linear editing (NLE) software.

Operability and Adaptability

Freely customizable compact design

The modular components, including the supplied monitor unit, handle unit and grip unit will let you expand and adapt the camera's configuration to match your shooting conditions (📖 39). The handle unit and supplied bracket have multiple cold accessory shoes and sockets for screws of different diameters to offer a large number of options for attaching additional accessories to the camera. You can also use the optional RD-1 Rod Clamp to attach to the camera commercially available viewfinders with a Ø 15 mm (0.59 in.) rod or replace the supplied monitor unit with the optional MA-400 Microphone Adapter for broadcast-style one-person operation.

The camera features a total of 22 buttons (on the camera's body, monitor unit and grip unit) to which you can assign a large number of functions (📖 131). Assign functions that you use often to the assignable buttons you find most convenient to personalize the camera to your needs and preferences.

Display options

The articulated monitor unit offers a 10.1-cm (4-in.) LCD screen and can be rotated 270° for maximum convenience. The unit cables connecting it to the camera can be easily replaced by optional, longer ones if necessary. On the camera's body, the viewfinder uses a 1.2-cm (0.46-in.) organic LED display that offers superior color reproduction and contrast. Both the LCD screen and viewfinder have 100% coverage, ensuring that you can compose your shots with ease.

Synchronization options

You can use the GENLOCK/SYNC OUT terminal and TIME CODE terminal to synchronize the camera with other devices (☞ 92), allowing it to be part of any multi-camera shooting setup. You can even output the time code signal and recording command through the HDMI OUT terminal (☞ 166, 185) to link the camera with a variety of external digital recorders.

Remote operation

You can attach the optional RC-V100 Remote Controller to the camera to control it from a distance. The remote controller lets you control a wide range of camera settings (☞ 119).

You can also attach the optional WFT-E6 Wireless File Transmitter to the camera and operate it remotely via Wi-Fi using the Browser Remote application (☞ 120). Browser Remote lets you check the live view image from the camera, adjust main camera settings and change the metadata embedded with the clips.

Versatile Artistic Expression

Special recording modes

The special recording modes (☞ 113) give you more creative control over your recordings. You can create a slow motion or fast motion effect in your recordings, record a certain number of frames at a set interval (ideal for nature shots and other subjects with little movement) or record a certain number of frames every time you press a button (ideal for stop motion animation).

Custom picture settings

The improved custom picture menu gives you even more options to control the “look” of your images. Select one of the preset picture settings or set the combination of gamma curve, color space and color matrix that you wish to use. Then, you can adjust a number of other image-related parameters in detail. With wide color space options such as BT.2020 Gamut and Cinema Gamut and gamma curves for impressive dynamic range like the new Canon Log 2 gamma, you can be sure that the camera covers your creative needs.

Other Functions

Software for aiding the production workflow

Canon XF Utility for XF-AVC (☞ 170) lets you copy the clips you recorded from your recording media to a computer, play back the clips and organize them. Cinema RAW Development can develop the 4K RAW data recorded with an external recorder and export it as a standard file type such as DPX or OpenEXR. You can also import an EDL to recreate an edit created on NLE software. This helps make a smooth transition to the color grading process.

Dual Pixel CMOS AF

The camera features the improved Dual Pixel CMOS AF, which covers almost 80% of the screen's height/width, and offers various autofocus functions (☞ 77): Continuous AF, One-shot AF (to use autofocus only when you choose) or AF-boosted MF (to let you focus manually most of the way and let the camera finish focusing automatically). Using AF-boosted MF the camera does not perform unreliable focus adjustments, resulting in a smoother focusing operation than with continuous AF. The camera can also focus automatically on people's faces (Face AF, ☞ 84) and track moving subjects while keeping them in focus.

You can control a number of AF-related settings including AF frame size and position, and AF speed. Even while focusing manually, the newly-added Dual Pixel Focus Guide function (☞ 79) serves as a visual, intuitive guide that you can use to check if the image is in focus and the required adjustment, if it is not. This can be very helpful to ensure you always get amazingly sharp 4K video.

Assistance functions

The camera offers a number of assistance functions, such as peaking and magnification (☞ 78), onscreen markers (☞ 86), zebra patterns (☞ 87) and B&W image (☞ 42), that you can display on the LCD screen or viewfinder, or output through the MON. terminal or HDMI OUT terminal to display on external monitors. When using a logarithmic gamma curve, you can also apply a LUT (☞ 167) to the displays or video output for easier monitoring.

Other improved features

- 5 levels of ND filter (☞ 69).
- In-camera correction for peripheral illumination and chromatic aberration (☞ 37).
- Illuminated buttons and rear panel for night time or black-out operation.
- Monaural built-in microphone for note taking.
- [Surrounding Icons], a new onscreen display mode that lets you check more of the image by placing icons and other indications on the periphery (☞ 58).
- Three sets of customizable My Menu submenus (☞ 33).

- Menu settings file that can be saved in the camera or on an SD card to restore all the menu settings or replicate them perfectly on another C300 Mark II camera (📖 146).
- Improved clip name format with more information for easier identification and organization of clips (📖 59).
- Metadata and geotagging (📖 106, 108, 128).
- Battery packs compatible with Intelligent System for better remaining usage time information.
- Improved DC IN terminal and cable plug for more robust connection.

Table of Contents

1. Introduction 11

About this Manual 11

Conventions Used in this Manual 11

Supplied Accessories 13

Names of Parts 14

Monitor Unit 19

Grip Unit 21

Handle Unit and Mounting Bracket 22

4K Workflow Overview 23

Color Grading with the ACES Workflow 24

2. Preparations 25

Preparing the Power Supply 25

Using a Battery Pack 25

Using a Power Outlet 27

Inserting the Lithium Button Battery 28

Turning the Camera On and Off 28

Attaching and Removing the Monitor Unit 29

Attaching the Monitor Unit 29

Removing the Monitor Unit 29

Date, Time and Language Settings 30

Setting the Date and Time 30

Changing the Language 31

Using the Menus 32

Selecting an Option from the Menu 32

Using the Customized Submenu (My Menu) 33

Preparing the Camera 36

Preparing the Lens 36

Configuring the Modular Units 39

Using the Viewfinder 40

Using the LCD Panel 40

Adjusting the Viewfinder/LCD Screen 41

Using a Tripod 42

Removing and Attaching the Grip Unit 43

Attaching the Handle Unit 44

Attaching the Shoulder Strap 44

Removing and Attaching the Terminal Covers 45

Preparing Recording Media 46

Compatible Recording Media 46

Inserting a CFast Card 47

Removing a CFast card 47

Inserting and Removing an SD Card 48

Initializing Recording Media 49

Switching Between the CFast Card Slots 50

Relay Recording and Double Slot Recording 50

Checking the Remaining Recording Time on

Recording Media 51

Recovering Clips 51

Adjusting the Black Balance 52

3. Recording 53

Recording Video 53

Preparing to Record 53

Recording 54

Onscreen Displays 55

Rear Panel Displays 59

Setting the Clip File Name 59

Using the Fan 61

Video Configuration: System Frequency, Frame Rate, Resolution and Bit Rate 62

Selecting the System Frequency 62

Selecting the Frame Rate 62

Selecting the Resolution and Color Sampling Settings 62

Selecting the Bit Rate 63

Changing Main Camera Functions with the FUNC. Button 64

Using the Direct Setting Mode 64

Shutter Speed 65

Changing the Shutter Speed Mode and Value 66

ISO Speed/Gain 67

Changing the ISO Speed or Gain Value 67

Using the Control Dial 68

ND Filter 69

Adjusting the Aperture 70

Manual Aperture 70

Momentary Automatic Aperture - Push Auto Iris 71

Automatic Aperture 72

Exposure Compensation - AE Shift 72

Light Metering Mode 73





- White Balance 74**
 - Custom White Balance 74
 - Color Temperature/Preset White Balance 75
 - Auto White Balance (AWB) 76
- Adjusting the Focus 77**
 - Manual Focus 78
 - One-Shot AF 80
 - AF-Boosted MF 81
 - Continuous AF 82
 - Changing the AF Frame Size and Position 83
 - Face Detection and Tracking 84
 - Tracking a Specific Subject 85
- Onscreen Markers and Zebra Patterns 86**
 - Displaying Onscreen Markers 86
 - Displaying Zebra Patterns 87
- Setting the Time Code 88**
 - Selecting the Time Code Mode 88
 - Selecting Drop or Non-Drop Frame 89
 - Putting the Time Code Display on Hold 89
- Setting the User Bit 91**
- Synchronizing with an External Device 92**
 - Connecting an External Device 92
 - Reference Video Signal Input (Genlock Synchronization) 93
 - Time Code Signal Input 93
 - Reference Video Signal Output 95
 - Time Code Signal Output 95
- Recording Audio 96**
 - Audio Settings and Recorded Audio Channels 96
 - Selecting the Audio Bit Depth 96
 - Connecting an External Microphone or External Audio Input Source to the Camera 97
 - Using the INPUT 1/INPUT 2 Terminals 98
 - Adjusting the Audio Level from the INPUT 1/INPUT 2 Terminals 99
 - Using the MIC Terminal 100
 - Monitoring the Audio with Headphones 101
- Colors Bars/Audio Reference Signal 102**
 - Color Bars 102
 - Audio Reference Signal 102
- Video Scopes 103**
 - Displaying the Waveform Monitor 103
 - Configuring the Waveform Monitor 103
- Adding Marks while Recording 105**
 - Adding Shot Marks while Recording 105
 - Adding an Mark or Mark while Recording 105
- Using Metadata 106**
 - Setting a User Memo Created with Canon XF Utility for XF-AVC 106
 - Entering Information About the Recording 107
- Recording GPS Information (Geotagging) 108**
- Reviewing a Recording 110**
- Simultaneous Recording of Proxy Clips 111**
- Special Recording Modes 113**
 - Slow & Fast Motion Recording Mode 113
 - Pre-recording Mode 115
 - Frame Recording Mode 116
 - Interval Recording Mode 117
- Using the Optional RC-V100 Remote Controller 119**
- Browser Remote: Controlling the Camera via Wi-Fi 120**
 - Preparations 120
 - Using Browser Remote 120
- 4. Customization 131**
- Assignable Buttons 131**
 - Changing the Assigned Function 131
 - Using an Assignable Button 132
- Custom Picture Settings 134**
 - Selecting Custom Picture Files 134
 - Preset Picture Settings 134
 - Editing a Custom Picture File's Settings 135
 - Resetting Custom Picture Files 136
 - Renaming Custom Picture Files 136
 - Protecting Custom Picture Files 136
 - Copying Custom Picture Files 137
 - Embedding Custom Picture Settings in a Clip 137
 - Available Custom Picture Settings 138
- Customizing Functions and Onscreen Displays 144**
 - Customizing Functions 144
 - Customizing Onscreen Displays 145
- Saving and Loading Camera Settings 146**
 - Saving Camera Settings 146
 - Loading Camera Settings 146

5. Playback 147

Playback 147

- Clip Index Screen 147
- Playing Back Clips 149
- Onscreen Displays 150
- Playback Controls 151
- Adjusting the Volume 151

Clip Operations 152

- Using the Clip Menu 153
- Displaying Clip Information 153
- Adding  Marks or  Marks 154
- Deleting  Marks or  Marks 155
- Copying Clips 155
- Deleting Clips 156
- Deleting the User Memo and GPS Information 156
- Copying a Custom Picture File Embedded in a Clip 157
- Displaying an Index Screen of Shot Marks 157
- Displaying a Frame Index Screen of a Single Clip 158
- Adding Shot Marks 158
- Deleting Shot Marks 159

6. External Connections 161

Video Output Configuration 161

- Recording Video Signal Configuration and Video Output Configuration by Terminal 161
- Playback Video Configuration and Video Output Configuration by Terminal 162

Connecting to an External Monitor or Recorder 163

- Connection Diagram 163
- Using the REC OUT terminal or MON. terminal 164
- Using the HDMI OUT Terminal 166
- Applying a LUT to Screens/Video Outputs 167
- Superimposing Onscreen Displays on Screens/Video Outputs 168

Audio Output 169

Saving Clips to a Computer 170

- Installing Canon XF Utility for XF-AVC (Windows) 170
- Installing Canon XF Utility for XF-AVC (Mac OS) 171
- Viewing the Software Instruction Manuals 171

Developing RAW Clips 172

- Installing Cinema RAW Development (Windows) 172
- Installing Cinema RAW Development (Mac OS) 172
- Viewing the Software Instruction Manual 173

7. Photos 175

Taking Photos 175

- Taking Photos in CAMERA Mode 175
- Grabbing Still Frames in MEDIA Mode 175
- Photo Numbering 176

Photo Playback 177

- Displaying the [Photos] Index Screen 177
- Viewing Photos 177
- Media Server: Viewing Photos on a Connected Wi-Fi Device 178

Deleting Photos 179

8. Additional Information 181

Menu Options 181

Displaying the Status Screens 191

Troubleshooting 199

- List of Messages 203

Handling Precautions 206

Maintenance/Others 209

Optional Accessories 210

Specifications 212

Reference Tables 217

Index 218

About this Manual

Thank you for purchasing the Canon EOS C300 Mark II. Please read this manual carefully before you use the camera and retain it for future reference. Should the camera fail to operate correctly, refer to *Troubleshooting* (📖 199).

Conventions Used in this Manual

- **!** IMPORTANT: Precautions related to the camera's operation.
- **i** NOTES: Additional topics that complement the basic operating procedures.
- **📖**: Reference page number.
- The following terms are used in this manual.
 - “Screen” refers to the LCD screen on the monitor unit and to the viewfinder screen on the camera.
 - “SD card” refers to an SD, SDHC or SDXC memory card.
 - “Recording media” refers to CFast cards and SD cards.
- Photographs in the manual are simulated pictures taken with a still camera. Some screenshots have been altered to make them easier to read.
- Illustrations in the manual show the Canon EOS C300 Mark II camera with a Canon EF 50mm f/1.4 USM lens attached.

The arrow is used to abbreviate menu selections. For a detailed explanation on how to use the menus, refer to *Using the Menus* (📖 32). For a concise summary of all available menu options and settings, refer to the appendix *Menu Options* (📖 181).

Operating modes

CAMERA indicates that a function is available in the operating mode indicated and **MEDIA** indicates that the function is not available. For a detailed explanation, refer to *Turning the Camera On and Off* (📖 28).

Setting the Time Code

In **CAMERA** mode, the camera generates a time code signal and records it with the recorded clips. The time code signal can also be output from the MON, terminal, REC OUT terminal, TIME CODE terminal or HDMI OUT terminal. In **MEDIA** mode, the time code embedded in the clip being played back can be output from the same terminals.

You can also synchronize the camera's time code with an external device (📖 95, 97). Depending on the frame rate used, you may be able to select between a drop frame and non-drop frame time code signal (📖 91). The default mode varies depending on the country/region of purchase and, though the time code display style is different for DF and NDF, in this section the NDF display style is used for simplicity's sake.

Operating modes: **CAMERA** **MEDIA**

Selecting the Time Code Mode

You can select the camera's time code mode.

1 Open the time code **[Mode]** submenu:
[Picture/Terminals Setup] → [Time Code] → [Mode]

2 Select the desired option and then press SET.

Options

[Preset]: The time code starts from an initial value you can select in advance. The default initial time code is 00:00:00.00. See the following procedures to select the time code running mode and set the initial time code.

[Regen.]: The camera will read the selected recording media and the time code will continue from the last time code recorded on the recording media. The time code runs only while recording so clips recorded consecutively on the same recording media will have continuous time codes.

[Picture/Terminals Setup]

[Time Code]

[Mode]

[Preset]

Setting the Time Code Running Mode

If you set the time code mode to **[Preset]**, you can select the time code running mode.

1 Open the time code **[Run]** submenu.
[Picture/Terminals Setup] → [Time Code] → [Run]

2 Select the desired option and then press SET.

Options

[Rec Run]: The time code runs only while recording so clips recorded consecutively on the same recording media will have continuous time codes.

[Free Run]: The time code starts running the moment you press SET and keeps running regardless of the

[Picture/Terminals Setup]

[Time Code]

[Run]

[Rec Run]

When a procedure requires selecting an option, the available options are listed within or after the procedure. Brackets [] are used to refer to menu options as they are displayed on screen.

When a function requires the use of the menu, the quick reference shows the submenus and, when applicable, the default setting for the menu item. The example illustration indicates that you can find the function by selecting the **[Picture/Terminals Setup]** menu and then the **[Time Code]** menu item.

Supplied Accessories

The following accessories are supplied with the camera.

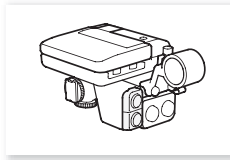

Monitor Unit

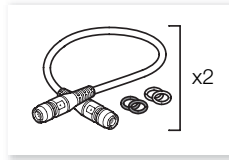

Two sets of UN-5 Unit Cable
(each, incl. color rubber O-rings (x 4))

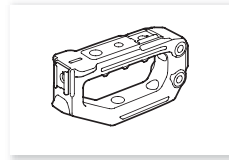

Handle Unit

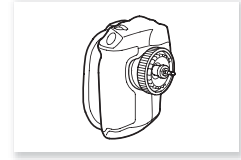

Grip Unit¹

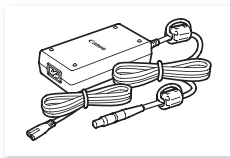

CA-A10 AC Adapter
(incl. power cord)

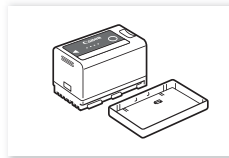

BP-A30 Battery Pack
(incl. terminal cover)

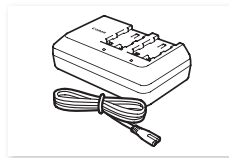

Battery Charger CG-A10
(incl. power cord)

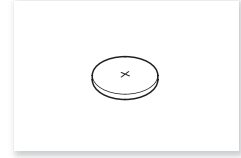

CR2025 Lithium Button Battery



Eye Cup



Viewfinder Cap

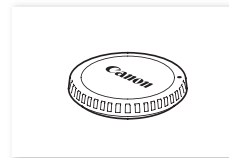

Body Cap¹

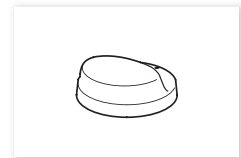

Thumb Rest

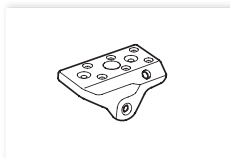

Mounting Bracket



Set of hex wrench and 0.64 cm (1/4")
hex socket head screws (x 10)



Adapter Base for
0.64 cm (1/4") Tripods



Extension Unit Attachment Bracket²

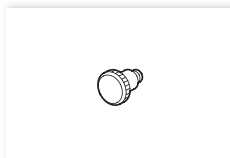

Tape Measure Hook¹

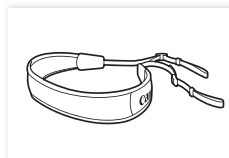

SS-1200 Shoulder Strap

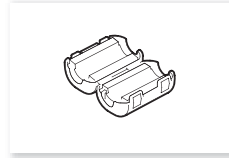

Ferrite Core

¹ Comes pre-attached to the camera.

² Used to secure the optional WFT-E6 Wireless File Transmitter or optional GP-E1 GPS Receiver when it is attached to the camera.

Names of Parts

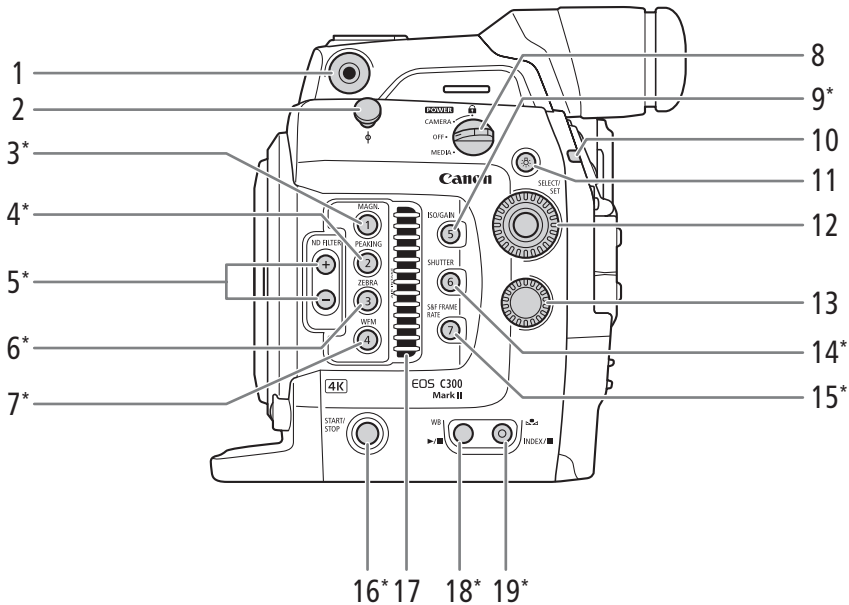

- | | |
|--|--|
| <p>1 Socket for the supplied mounting bracket (44)</p> <p>2 Tape measure hook and ϕ focal plane mark</p> <p>3 MAGN. (magnification) button (79)/
Assignable button Camera 1 (131)</p> <p>4 PEAKING button (79)/
Assignable button Camera 2 (131)</p> <p>5 ND FILTER +/- buttons (69)</p> <p>6 ZEBRA button (87)/
Assignable button Camera 3 (131)</p> <p>7 WFM (waveform monitor) button (103)/
Assignable button Camera 4 (131)</p> <p>8 POWER switch (28)</p> <p>9 ISO/GAIN button (67)/
Assignable button Camera 5 (131)</p> <p>10 Tally lamp (54)</p> <p>11 \star (illumination) button
Turns on/off the illumination of buttons marked
with an asterisk on this page as well as the rear
panel's backlight (59). This is convenient for
night time or black-out operation.</p> | <p>12 SELECT dial/SET button (32)</p> <p>13 Control dial (68, 70, 72)</p> <p>14 SHUTTER (shutter speed mode) button (65)/
Assignable button Camera 6 (131)</p> <p>15 S&F FRAME RATE (shooting frame rate for slow &
fast motion recording) button (113)/
Assignable button Camera 7 (131)</p> <p>16 START/STOP button (54)</p> <p>17 Air intake vent (61)</p> <p>18 WB (white balance) button (74)/
$\blacktriangleright/\parallel$ (play/pause) button (149)</p> <p>19 \star (white balance adjustment) button (74)/
INDEX button (148)/
\blacksquare (stop) button (149)</p> |
|--|--|

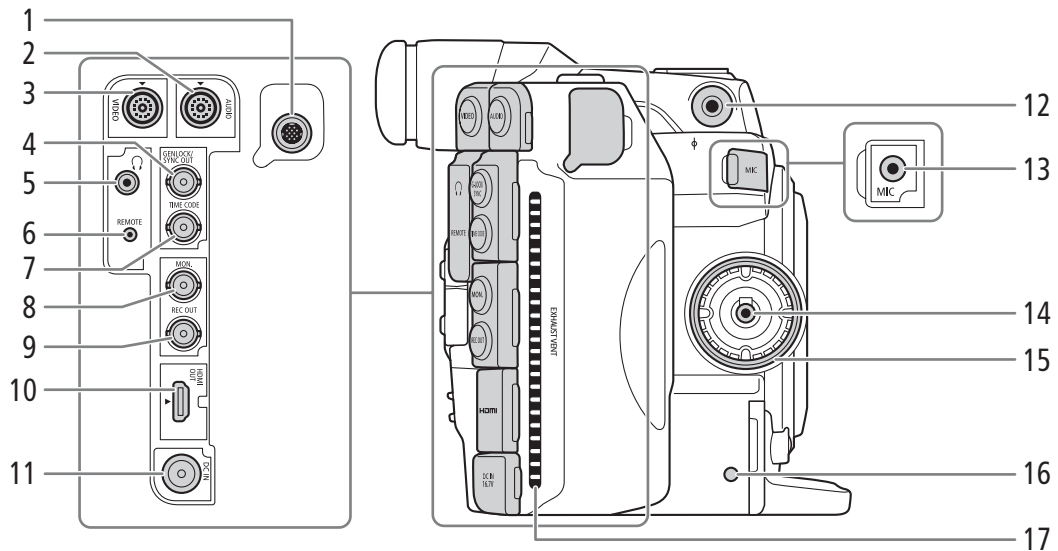

- | | | | |
|---|--|----|--|
| 1 | System extension terminal (108, 120) | 8 | MON. terminal (161, 164) |
| 2 | AUDIO terminal (29) | 9 | REC OUT terminal (161, 164) |
| 3 | VIDEO terminal (29) | 10 | HDMI OUT terminal (161, 166) |
| 4 | GENLOCK terminal (92)/SYNC OUT
(synchronizing signal output) terminal (92) | 11 | DC IN terminal (27) |
| 5 | 🎧 (headphone) terminal (101) | 12 | Socket for the supplied mounting bracket (44) |
| 6 | REMOTE terminal
For connecting the optional RC-V100 Remote
Controller or commercially available remote
controllers. | 13 | MIC (microphone) terminal (97, 100) |
| 7 | TIME CODE terminal (93, 95) | 14 | Grip unit connection terminal (43) |
| | | 15 | Grip unit attachment thread (43) |
| | | 16 | SD card access indicator (48) |
| | | 17 | Exhaust ventilation outlet (61) |

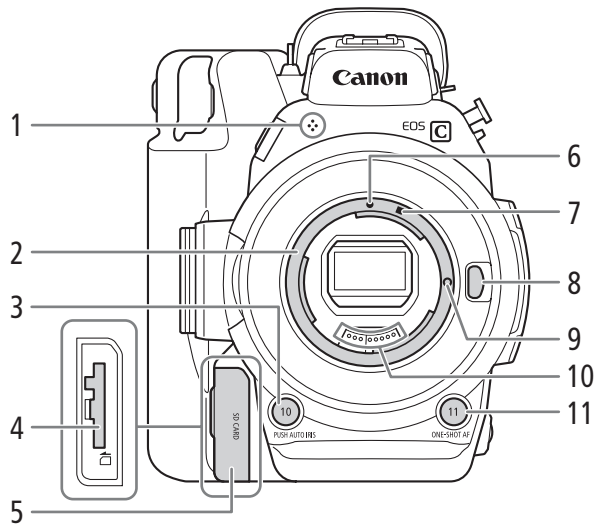

- | | |
|--|--|
| 1 Built-in monaural microphone (101) | 7 EF-S lens mount index (36) |
| 2 EF lens mount (36) | 8 Lens release button (36) |
| 3 PUSH AUTO IRIS (momentary automatic aperture) button (71)/ Assignable button Camera 10 (131) | 9 EF lens lock pin (36) |
| 4 SD card slot (48) | 10 EF lens contacts (36) |
| 5 SD card slot cover (48) | 11 ONE-SHOT AF (focus automatically once) button (80)/ Assignable button Camera 11 (131) |
| 6 EF lens mount index (36) | |

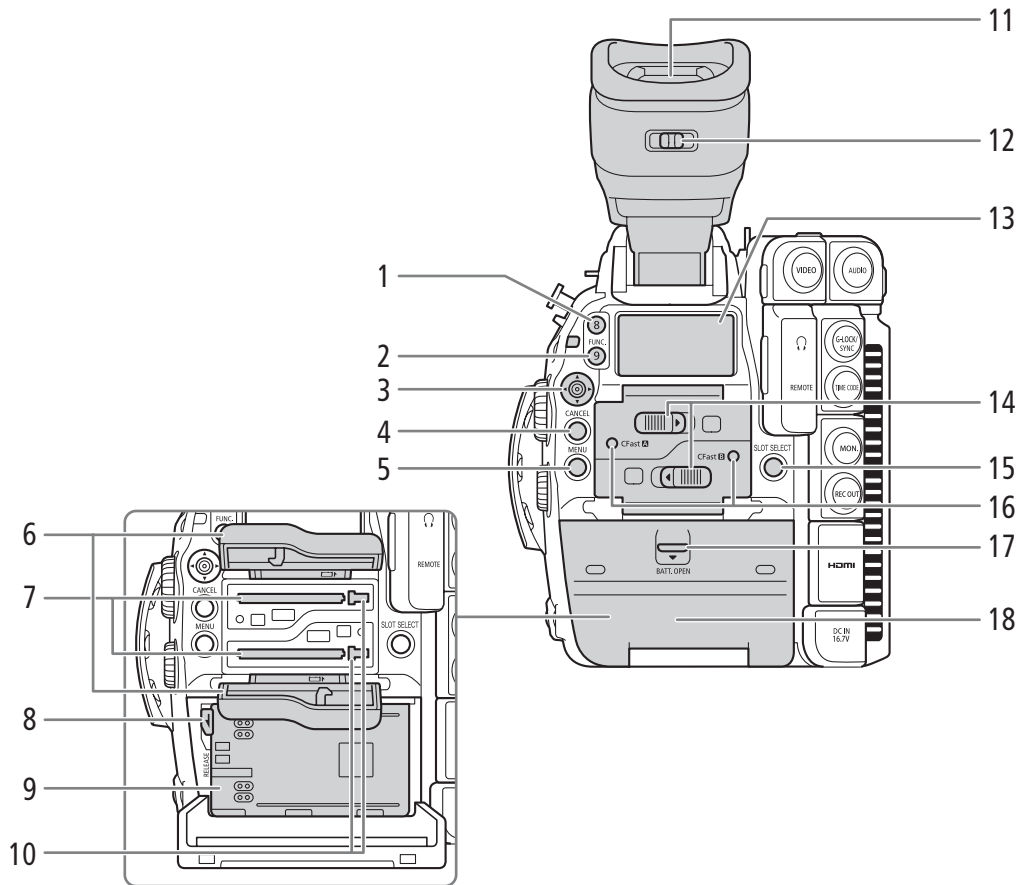

- | | | | |
|----|---|----|---|
| 1 | Assignable button Camera 8 (📖 131) | 11 | Viewfinder (📖 40, 41) |
| 2 | FUNC. (main functions) button (📖 64)/
Assignable button Camera 9 (📖 131) | 12 | Dioptic adjustment lever (📖 40) |
| 3 | Joystick (📖 32)/SET button (📖 32) | 13 | Rear panel (📖 59) |
| 4 | CANCEL button (📖 32) | 14 | Card slot cover switches for CFast card slots A
(top) and B (bottom) (📖 47) |
| 5 | MENU button (📖 32, 131) | 15 | SLOT SELECT (CFast card selection) button
(📖 50, 148) |
| 6 | Card slot covers for CFast card slots A (top) and B
(bottom) | 16 | CFast A (CFast card slot A) and CFast B (CFast
card slot B) access indicators (📖 47) |
| 7 | CFast card slots A (top) and B (bottom) (📖 47) | 17 | BATT. OPEN (open battery compartment) switch
(📖 26) |
| 8 | RELEASE (battery release) latch (📖 26) | 18 | Battery compartment cover (📖 26) |
| 9 | Battery compartment (📖 26) | | |
| 10 | Card release buttons for CFast card slots A (top)
and B (bottom) (📖 47) | | |

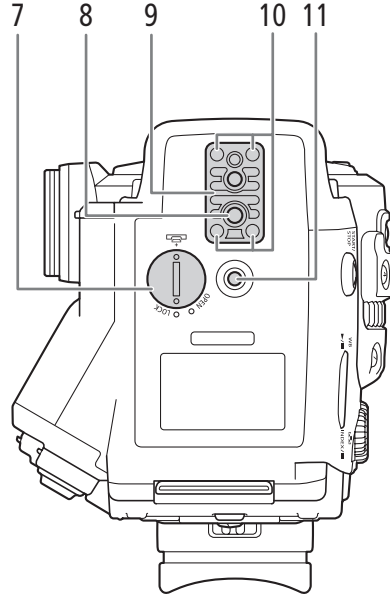
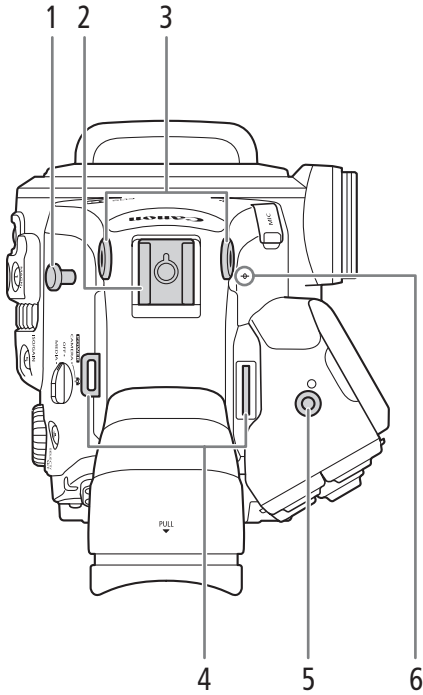

- 1 Tape measure hook
Use the hook to accurately measure the distance from the focal plane.
- 2 Accessory shoe with socket for 0.64 cm (1/4") screws
For attaching accessories such as the optional VL-10Li II Battery Video Light.
- 3 Sockets for the supplied mounting bracket (☞ 44)
- 4 Strap mounts (☞ 44)

- 5 Socket for the extension unit attachment bracket (☞ 108, 120)
- 6 ϕ Focal plane mark
- 7 Compartment cover for the lithium button battery (☞ 28)
- 8 Tripod socket (☞ 42)
- 9 TB-1 Tripod Base for tripods with 0.95 cm (3/8 in.) screws (☞ 42)
- 10 Tripod base screws (☞ 42)
- 11 Socket for 0.64 cm (1/4") screws

Monitor Unit

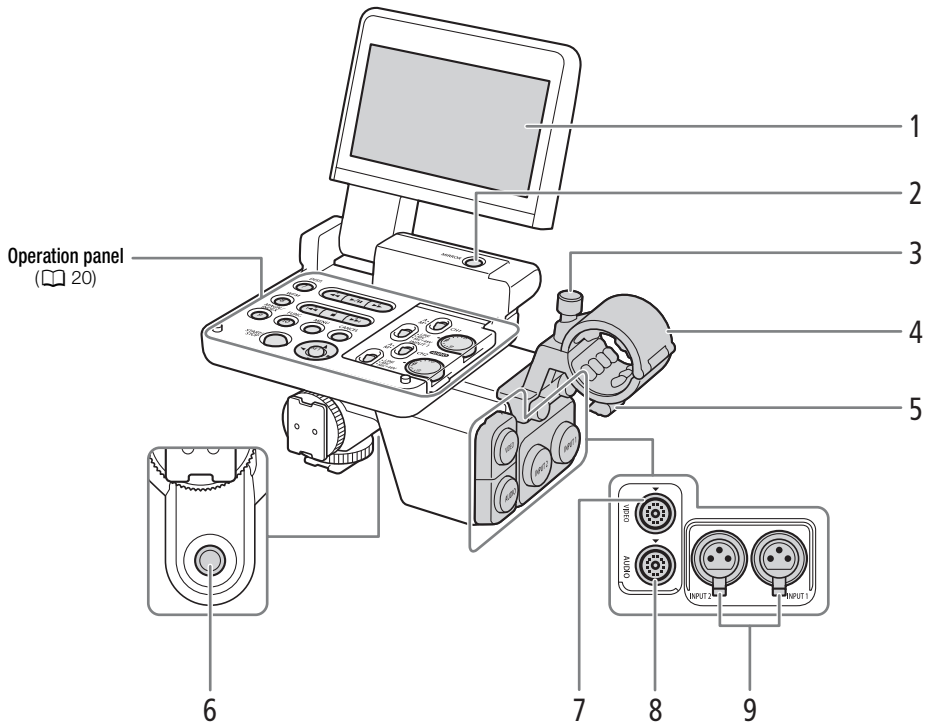

- | | |
|--|--|
| 1 LCD panel (see pages 40, 41) | 6 Socket for 0.64 cm (1/4") screws |
| 2 MIRROR (invert the displayed image) button (see page 41) | 7 VIDEO terminal (see page 29) |
| 3 Microphone lock screw (see page 97) | 8 AUDIO terminal (see page 29) |
| 4 Microphone holder (see page 97) | 9 INPUT terminals (XLR): INPUT 1 (right) and INPUT 2 (left) (see pages 97, 98) |
| 5 Microphone cable clamp (see page 97) | |

Operation panel

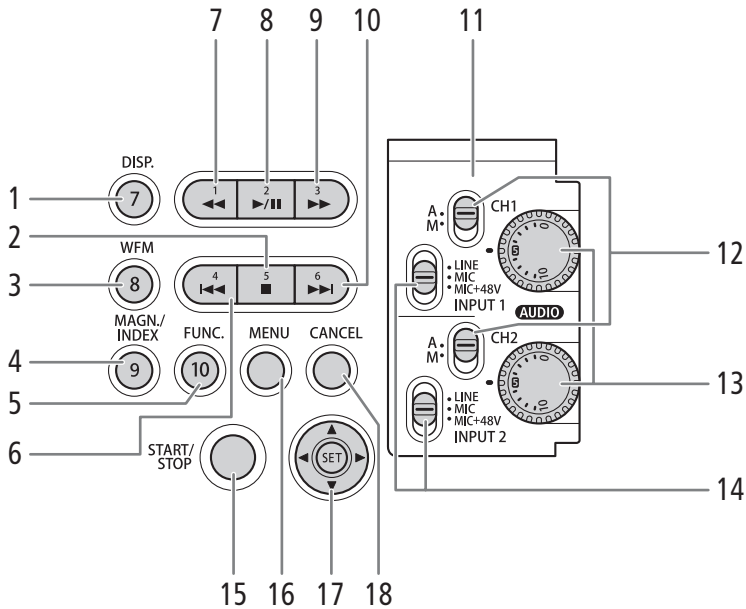

- 1 DISP. (display) button (📖 55, 150)/
Assignable button Monitor 7 (📖 131)
- 2 ■ (stop) button (📖 149)/
Assignable button Monitor 5 (📖 131)
- 3 WFM (waveform monitor) button (📖 103)/
Assignable button Monitor 8 (📖 131)
- 4 MAGN. (magnification) button (📖 79)/
INDEX button (📖 148)/
Assignable button Monitor 9 (📖 131)
- 5 FUNC. (main functions) button (📖 64)/
Assignable button Monitor 10 (📖 131)
- 6 ◀◀ (skip backward) button (📖 151)/
Assignable button Monitor 4 (📖 131)
- 7 ◀◀ (fast reverse playback) button (📖 151)/
Assignable button Monitor 1 (📖 131)
- 8 ▶/|| (play/pause) button (📖 149)/
Assignable button Monitor 2 (📖 131)

- 9 ▶▶ (fast playback) button (📖 151)/
Assignable button Monitor 3 (📖 131)
- 10 ▶▶ (skip forward) button (📖 151)/
Assignable button Monitor 6 (📖 131)
- 11 Protective cover for audio controls (📖 99)
- 12 Audio level switches for CH1 (top) and CH2
(bottom) (📖 99)
- 13 **AUDIO** (audio level) dials for CH1 (top) and CH2
(bottom) (📖 99)
- 14 INPUT 1 (top)/ INPUT 2 (bottom) switches (audio
source selection) (📖 98)
- 15 START/STOP button (📖 54)
- 16 MENU button (📖 32, 131)
- 17 Joystick (📖 32)/SET button (📖 32)
- 18 CANCEL button (📖 32)

Grip Unit

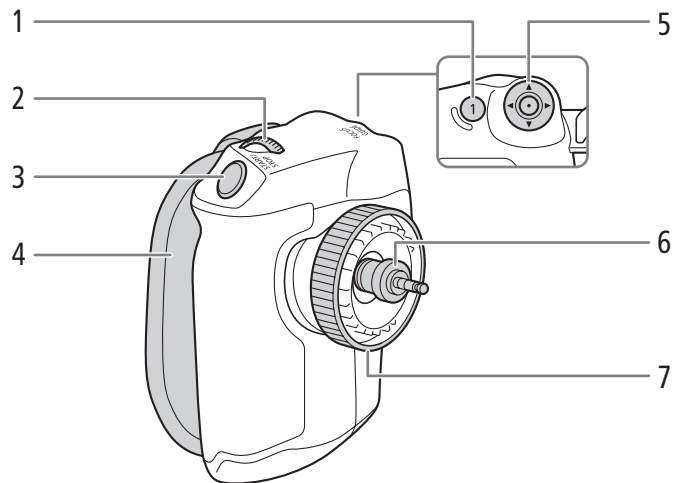

- | | | | |
|---|--|---|-----------------------------------|
| 1 | FOCUS GUIDE button (📖 79)/
Assignable button Grip 1 (📖 131) | 4 | Grip belt (📖 43) |
| 2 | Control dial (📖 68, 70, 72) | 5 | Joystick (📖 32)/SET button (📖 32) |
| 3 | START/STOP button (📖 54) | 6 | Connection plug (📖 43) |
| | | 7 | Lock screw (📖 43) |

Handle Unit and Mounting Bracket

22

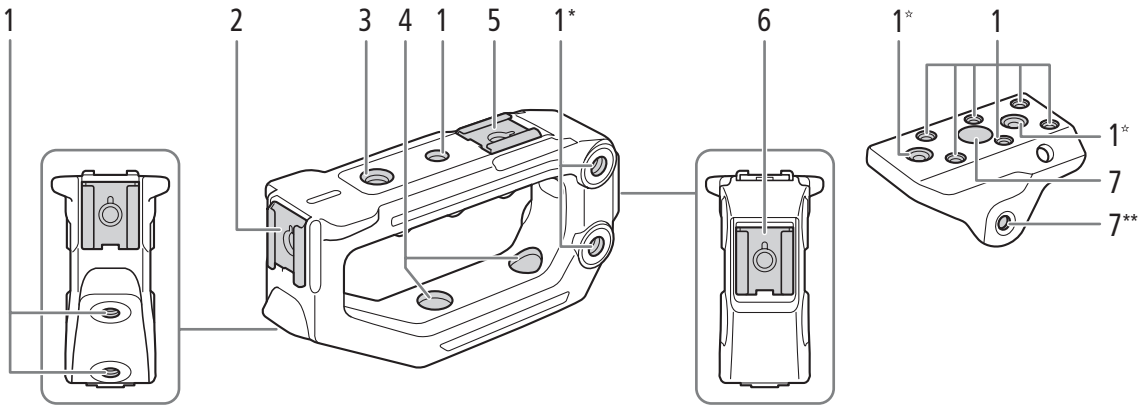

- * Two more in the same location on the opposite side.
- ** One more in the same location on the opposite side.

- | | |
|---|--|
| <ul style="list-style-type: none"> 1 Sockets for 0.64 cm (1/4") screws
7 in total on the handle unit; 8 in total on the bracket, of which, those marked with a star ☆ are used to attach the handle unit to the bracket (📖 44). 2 Front accessory shoe*** 3 Socket for 0.95 cm (3/8") screws | <ul style="list-style-type: none"> 4 Thru-hole mounting holes for attaching the handle unit to the bracket (📖 44) 5 Top accessory shoe*** 6 Rear accessory shoe*** 7 Thru-hole mounting holes for attaching the bracket to the camera (📖 44) |
|---|--|

*** With socket for 0.64 cm (1/4") screws

4K Workflow Overview

The following illustrates the typical 4K workflow for this camera.

Operating modes: CAMERA MEDIA

23

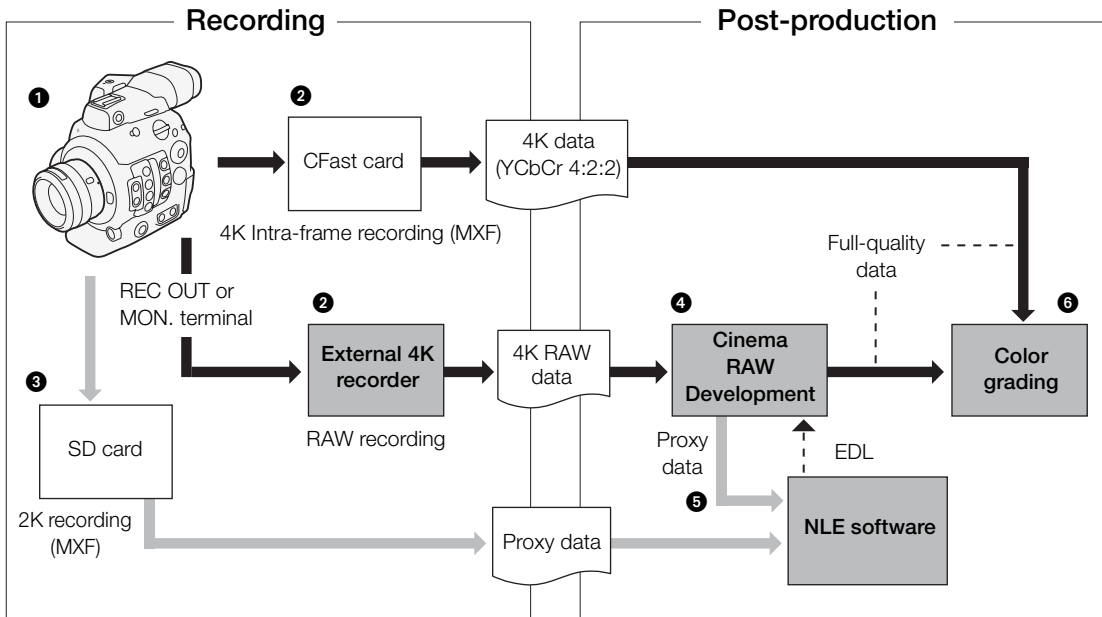

- 1 Shoot in 4K mode (📖 62).
- 2 You can record 4K Intra-frame (YCbCr 4:2:2) data on a CFast card in the camera, or record 4K RAW data using an external 4K recorder connected to the camera's REC OUT terminal or MON. terminal (📖 164).
- 3 In addition to the primary 4K recording, you can record simultaneously 2K proxy clips on an SD card in the camera (📖 111).
- 4 When using an external 4K recorder, develop the RAW data using the Cinema RAW Development software (📖 172) to generate full-quality data.
 - You can also generate proxy data with the software.
 - 4K clips (YCbCr 4:2:2) recorded on the CFast card can be treated as full-quality data without any additional processing.
- 5 Transfer the MXF files of proxy clips recorded in the camera, or proxy data generated by the software, to your NLE system and edit offline (📖 170).
- 6 Perform color grading based on the full-quality data.

Color Grading with the ACES Workflow

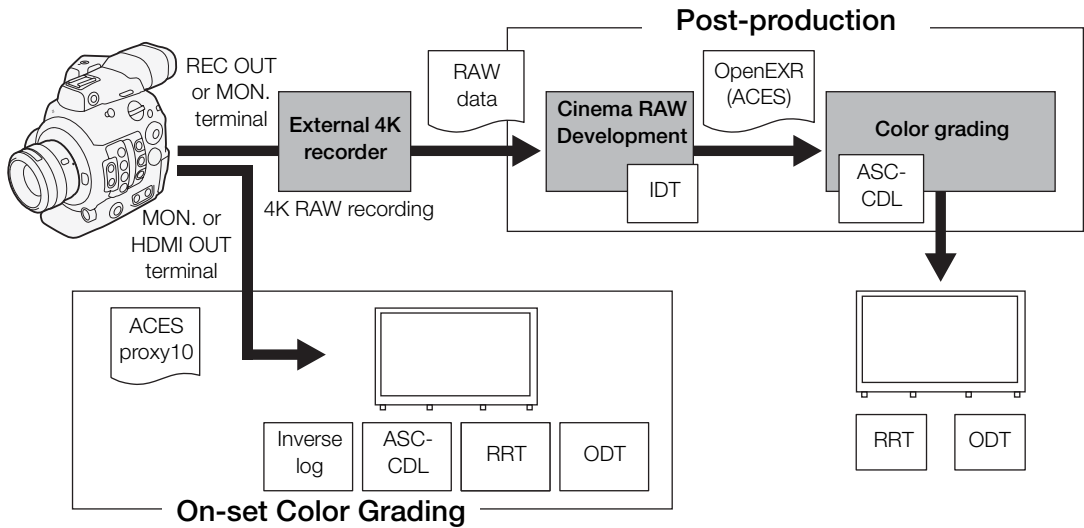

ACESproxy10: ACESproxy10 video data that is output from the MON. terminal or HDMI OUT terminal when performing on-set color grading. Select the [ACESproxy10] option for the [Assistance Functions] ► [LUT] setting of the appropriate terminal to enable ACESproxy10 output.

ASC-CDL: Refers to the list that contains color grading adjustment data. This step requires equipment compatible with ASC-CDL.

IDT: Input Device Transform. Refers to the table used for converting color information of the input device to ACES color space.

ODT: Output Device Transform. Refers to the table used for converting ACES color space information to the color information of the ideal display device.

RRT: Reference Rendering Transform. Refers to the table used for converting data from ACES color space to the color information of the ideal display device.

Preparing the Power Supply

You can power the camera using a battery pack or directly using the AC adapter. If you connect the AC adapter to the camera while a battery pack is attached, the camera will draw power from the power outlet.

Using a Battery Pack

You can power the camera using the supplied BP-A30 Battery Pack or the optional BP-A60 Battery Pack. Both battery packs are compatible with Intelligent System so you can check the approximate remaining battery usage time (in minutes) on the screen. For more accurate readings, when using a battery pack for the first time, charge it fully and then use the camera until the battery pack is completely exhausted.

Charging the Battery Pack

Charge battery packs using the supplied CG-A10 Battery Charger. Before charging, remove the terminal cover of the battery pack.

- 1 Connect the power cord to the battery charger.
- 2 Plug the power cord into a power outlet.
- 3 Attach the battery pack to the battery charger.
 - Press lightly and slide the battery pack in the direction of the arrow until it clicks.
 - The CHARGE indicator starts flashing and also indicates the battery pack's approximate charge. The indicator will stay on when charging has completed.
 - You can charge two battery packs simultaneously.

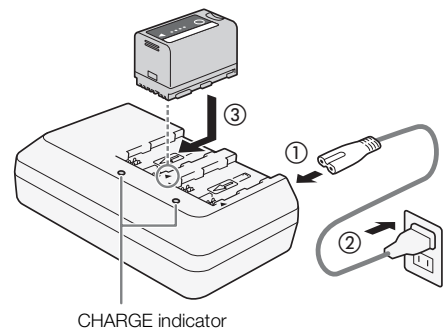

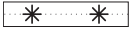
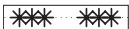
	approx. 0% to 49%: Flashes once every 2 seconds
	approx. 50% to 74%: Flashes twice every 2 seconds
	approx. 75% to 99%: Flashes 3 times every 2 seconds

- 4 When charging has completed, remove the battery pack from the battery charger.
- 5 Unplug the power cord from the power outlet and disconnect it from the battery charger.

! IMPORTANT

- Do not connect to the battery charger any product that is not expressly recommended for use with this camera.
- When using the battery charger, do not fix it permanently to one place as this may cause a malfunction.
- To prevent equipment breakdowns and excessive heating, do not connect the supplied battery charger or AC adapter to voltage converters for overseas travels or special power sources such as those on aircraft and ships, DC-AC inverters, etc.

i NOTES

- We recommend charging the battery pack in temperatures between 10 °C and 30 °C (50 °F and 86 °F). Outside the temperature range of 0 °C to 40 °C (32 °F to 104 °F), charging will not start.

- If there is a malfunction with the battery charger or battery pack, the charge indicator will go out and charging will stop.
- For handling precautions regarding the battery pack, refer to *Battery Pack* (□ 206).
- For approximate charging times, refer to the *Reference Tables* (□ 217). For approximate recording times with a fully charged battery pack, refer to the *Specifications* (□ 214).
- Charged battery packs continue to discharge naturally. Therefore, charge them on the day of use, or the day before, to ensure a full charge.
- We recommend that you prepare battery packs to last 2 to 3 times longer than you think you might need.
- Repeatedly charging and discharging the battery pack will eventually shorten its battery life. You can check the battery life on the [Battery/Hour Meter] status screen (□ 197). Fully charging the battery pack and then discharging it completely will give you a more accurate reading.
- **USA and Canada only:** The Lithium ion/polymer battery that powers the product is recyclable. Please call 1-800-8-BATTERY for information on how to recycle this battery.



Attaching the Battery Pack

- 1 Set the **POWER** switch to OFF.
- 2 Slide the BATT. OPEN switch in the direction of the arrow and open the battery compartment cover.
- 3 Insert the battery pack all the way into the compartment as shown in the illustration and press it gently toward the left until it clicks.
- 4 Close the battery compartment cover.
 - When using the optional BP-A60 Battery Pack, the cover cannot be closed. Refer to *Using higher capacity batteries* (□ 207).

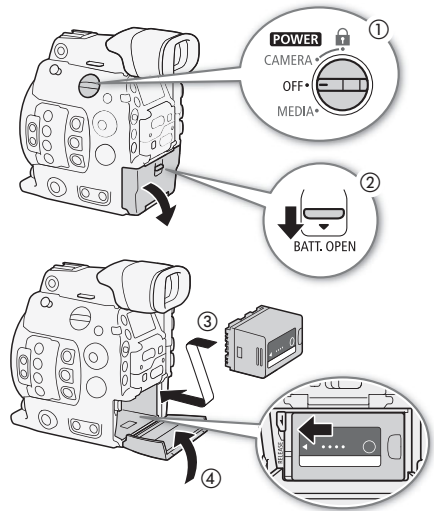

Removing the Battery Pack

- 1 Set the **POWER** switch to OFF.
- 2 Slide the BATT. OPEN switch in the direction of the arrow and open the battery compartment cover.
- 3 Holding down the RELEASE latch, slide the battery pack toward the right and then pull it out.
- 4 Close the battery compartment cover.

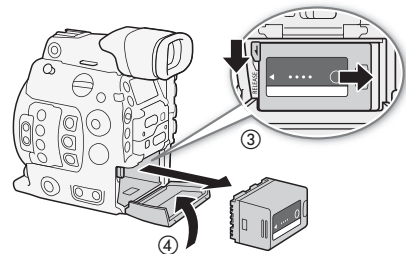

Checking the Remaining Battery Charge

When the camera is turned on, you can check the approximate remaining battery usage time (in minutes) by looking at any recording/playback screen or the [Battery/Hour Meter] status screen (197). You can also check the approximate charge level on the battery pack itself.

Press the CHECK button on the battery pack. An indicator will light for approximately 3 seconds and show the approximate remaining battery charge.

	0-25%
	26-50%
	51-75%
	76-100%

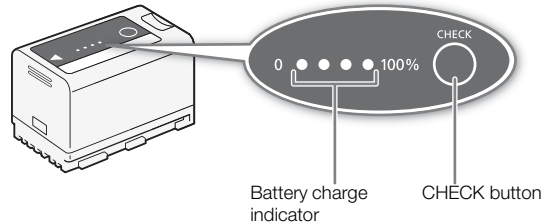

Using a Power Outlet

You can also power the camera directly from a power outlet using the supplied CA-A10 AC Adapter. While the camera is powered using a power outlet, you can replace the battery pack even when the camera is turned on.

Attaching the Ferrite Core

Before using the supplied CA-A10 AC Adapter, attach the supplied ferrite core to the power cord. This can help reduce the likelihood of RF interference.

- 1 Attach the ferrite core to the power cord about 4 cm (1.6 in.) from the plug that goes into the AC adapter.
- 2 Pass the cable through the center of the core and wrap it around the core twice and close the ferrite core.
 - For use in North America, you only need to wrap the cable around the core once.

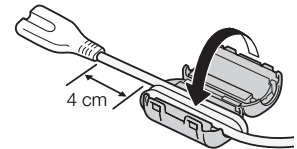

Connecting the AC Adapter

- 1 Set the **POWER** switch to OFF.
- 2 Connect the AC adapter's DC plug to the DC IN terminal on the camera.
 - Align the cable so the red dot on the plug is facing up.
 - To disconnect the AC adapter, pull back the metallic tip of the plug and then disconnect the cable from the terminal.
- 3 Connect the power cord to the AC adapter and plug it into a power outlet.

! IMPORTANT

- Make sure to turn off the camera before connecting or disconnecting the AC adapter.
- When using the AC adapter, do not fix it permanently to one place as this may cause a malfunction.

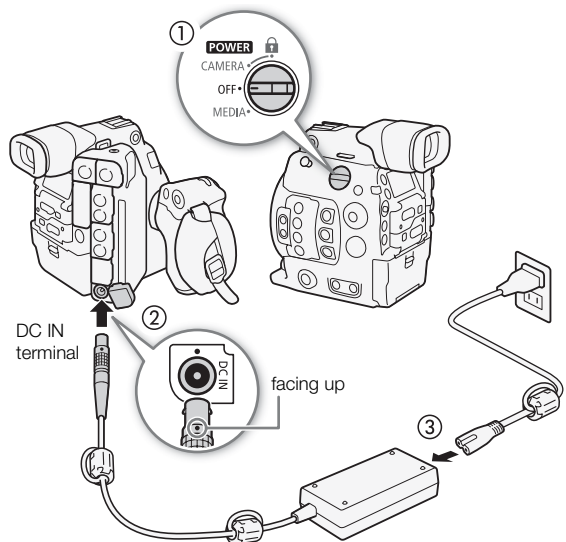

Inserting the Lithium Button Battery

The supplied CR2025 lithium button battery ensures that any settings saved on the camera are not lost when no power source (battery pack or AC adapter) is connected to the camera.

- 1 Make sure no battery pack is attached to the camera and the AC adapter is not connected.
- 2 Turn the lithium battery compartment cover to the OPEN position and remove the cover.
 - Use a coin or a similar tool. If you keep turning the cover beyond the OPEN point, the cover will rise a little, making it easier to grab.
- 3 Insert the supplied lithium button battery with the + side facing up.
- 4 Replace the cover and turn it to the LOCK position to lock it.

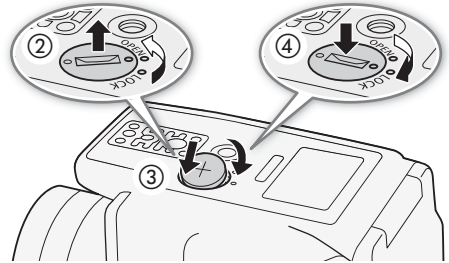

i NOTES

- Removing the lithium button battery when no other power source is connected to the camera will reset all the camera's settings to default values. To avoid losing the settings, you can save them on an SD card in advance (146).

Turning the Camera On and Off

The camera has two operating modes: CAMERA (CAMERA) mode for making recordings and MEDIA (MEDIA) mode for playing back recordings. Select the operating mode using the POWER switch.

To turn on the camera

Set the POWER switch to CAMERA for CAMERA mode or MEDIA for MEDIA mode.

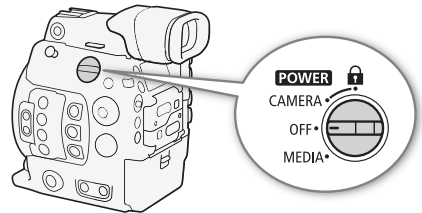
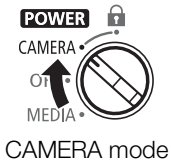

To turn off the camera

Set the POWER switch to OFF.

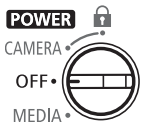

Attaching and Removing the Monitor Unit

You can attach the monitor unit to the accessory shoe on the camera or to one of those on the handle unit. Further ahead you will find details about using the LCD panel and adjusting the LCD screen (40, 41).

Attaching the Monitor Unit

- 1 Set the **POWER** switch to OFF.
- 2 Insert the attachment base of the monitor unit to the camera's accessory shoe or to one of the handle unit's accessory shoes.
 - You can use the attachment base at the back of the monitor unit to attach it to the accessory shoe on the front of the handle unit.
- 3 Tighten the monitor unit's lock screw.
- 4 Using the two supplied unit cables, connect the camera's AUDIO terminal to the monitor unit's AUDIO terminal and the camera's VIDEO terminal to the monitor unit's VIDEO terminal.
 - Align the ▲ marks on cables' plugs and terminals.
 - The unit cables are interchangeable and either can be used to connect the AUDIO or VIDEO terminals. You can use the two pairs of supplied rubber O-rings to color-code the cables for easy identification.

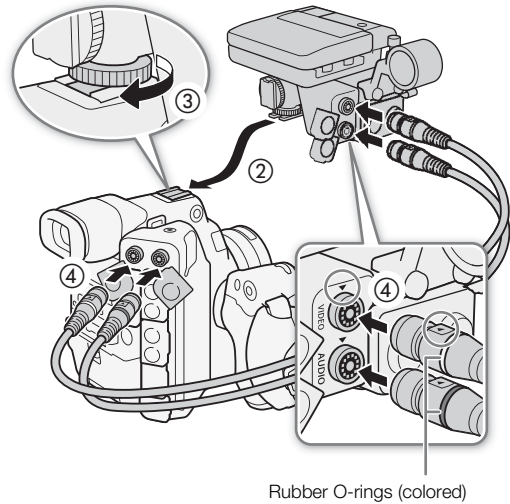

Removing the Monitor Unit

- 1 Set the **POWER** switch to OFF.
- 2 Disconnect the two unit cables from the camera's and monitor unit's AUDIO and VIDEO terminals.
 - Pull back the metallic tip of the plug and then disconnect the cable from the terminal.
- 3 Unscrew the lock screw and then gently slide out the monitor unit from the accessory shoe.

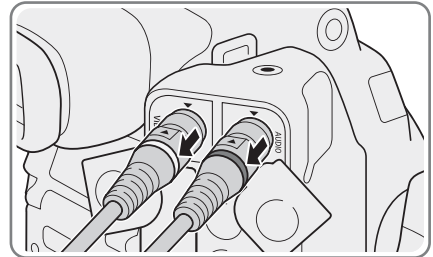

! IMPORTANT

- Be careful not to drop the camera when attaching or removing the monitor unit.

Date, Time and Language Settings

Setting the Date and Time

You will need to set the date and time on the camera before you can start using it. When the internal clock is not set, or if the settings were lost because the lithium button battery is depleted, the [Set Clock > Date/Time] screen will appear automatically with the time zone selected when you turn on the camera.

Operating modes: CAMERA MEDIA

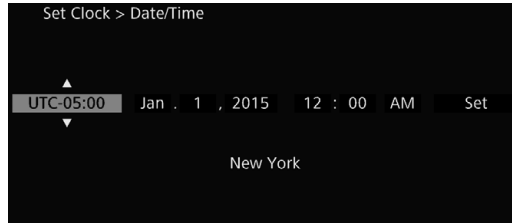





1 Push the joystick up/down to select the desired time zone and then press SET to move to the next field.

- To move to the next field you can also push the joystick right.
- The default time zone is [UTC-05:00] (New York) or [UTC+01:00] (Central Europe), depending on the country/region of purchase. Time zones are based on Coordinated Universal Time (UTC).

2 Change the rest of the fields in the same way.

3 Select [Set] and then press SET to start the clock and close the screen.

NOTES

- You can display the date/time in CAMERA mode with the [ Picture/Terminals Setup] ➤ [Custom Display 2] ➤ [Date/Time] setting.
- With the following settings*, you can change the time zone, date and time also after the initial setup. You can also change the date format and clock format (12 or 24 hours).
 - [ System Setup] ➤ [Time Zone]
 - [ System Setup] ➤ [Set Clock] ➤ [Date/Time] and [Date Format]
- When the lithium button battery is depleted, all menu settings may be lost. In such case, replace the lithium button battery (CR2025) and perform the initial setup again.
- Using the optional GP-E1 GPS Receiver, you can have the camera adjust settings automatically according to the UTC date/time information received from the GPS signal ( 108).

* These settings are not available while Browser Remote ( 120) is activated.

Changing the Language

The camera's default language is English. You can change it to German, Spanish, French, Italian, Polish, Portuguese, Russian, Simplified Chinese, Korean or Japanese. Please note that some settings and screens will be displayed in English, regardless of the language setting.

Operating modes: CAMERA MEDIA

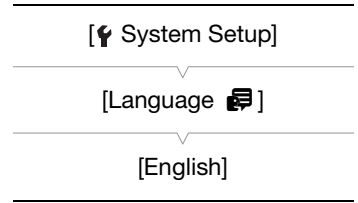

- 1 Press the MENU button.
- 2 Push the joystick up/down or turn the SELECT dial to select [System Setup] and then press SET.
- 3 Select [Language] in a similar fashion and then press SET.
- 4 Push the joystick up/down or turn the SELECT dial to select a language.
- 5 Press SET to change the language and then press the MENU button to close the menu.

Using the Menu

In **CAMERA** mode, many of the camera's functions can be adjusted from the menu that opens after pressing the MENU button. You can also register frequently used menu settings in a customized submenu (My Menu) for easy access. In **MEDIA** mode, press the MENU button to open the menu or SET to open the clip menu for clip operations (152). For details about the available menu options and settings, refer to *Menu Options* (181).

Operating modes: **CAMERA** **MEDIA**

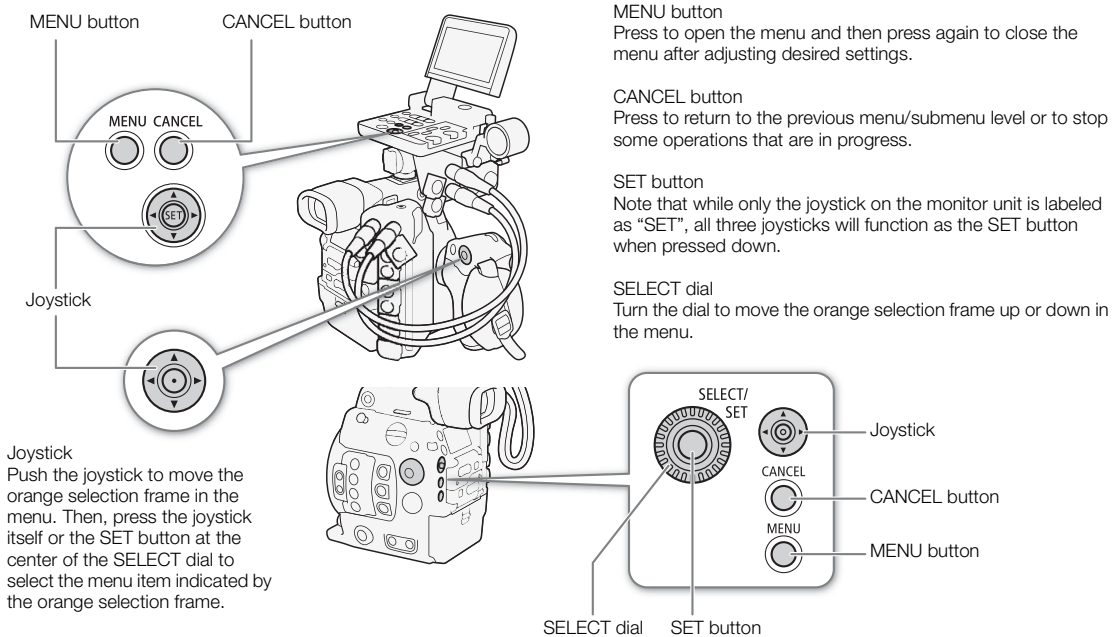

Selecting an Option from the Menu

The following is a step-by-step explanation of how to select an option from the menu. In the procedures throughout the rest of this manual, opening and closing the menu is assumed and not included in the procedure.

1 Press the MENU button.

- The menu opens with the orange selection frame indicating the menu item that was selected the previous time the menu was closed (unless the camera was turned off).

2 Push the joystick up/down or turn the SELECT dial to select the desired submenu.

3 Push the joystick right or press SET.

- The orange selection frame will appear on a menu item in the submenu.
- Press the CANCEL button, push the joystick left, or select [↩] to return to the previous submenu.

4 Push the joystick up/down or turn the SELECT dial to select the desired menu item.

- If a submenu contains many menu items, a scroll bar will appear on the right side of the submenu indicating that you must scroll up or down to see other menu items.
- A ► mark to the right of a menu item indicates another submenu. Repeat steps 3 and 4.

5 Push the joystick right or press SET.

- The orange selection frame will appear on a setting option.
 - Press the CANCEL button to return to the previous submenu.
- 6 Push the joystick up/down or turn the SELECT dial to select the desired setting option and then press SET.
- Depending on the menu item, additional selections may be necessary.
- 7 Press the MENU button to close the menu.

i NOTES

- Unavailable items may appear grayed out.
- Pressing the MENU button at any time closes the menu.
- On some screens, the following icons may be displayed as a guide: **SET**, **MENU**, **CANCEL**. They refer, respectively, to pressing the joystick (or SET button at the center of the SELECT dial or on a remote control), the MENU button or the CANCEL button.
- When an optional RC-V100 Remote Controller is connected to the camera, you can use the remote controller's up/down/left/right/SET buttons in the same way as the camera's joystick.
- You can check most of the current settings on the status screens (📖 191).

Using the Customized Submenu (My Menu)

You can register up to 15 frequently used menu settings under a My Menu submenu for easy access. You can save up to 3 separate sets of My Menu settings so you can customize different options for different shooting situations. Furthermore, if you set an assignable button to [My Menu] (📖 131), you can press the button to access your registered menu settings even faster and more easily.

Selecting a My Menu Set

- 1 Open the My Menu [Select] screen.
[★₁ My Menu 1] ➡ [Select]
- 2 Select the desired My Menu set and then press SET.

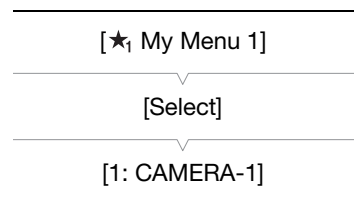

Adding Menu Settings

- 1 Open the My Menu [Register] screen.
[★₁ My Menu 1]* ➡ [Edit] ➡ [Register]
 - The menu's title bar will change to blue to indicate you are selecting menu settings to add to the My Menu submenu.
 - Press the CANCEL button to cancel the operation and return to the regular menu.
- 2 Navigate the menus to find the menu setting you want to add and then press SET.
- 3 Select [OK] and then press SET twice.
 - The menu setting you registered will now appear under the currently selected My Menu set.

* Default setting. You can select a different My Menu set in advance.

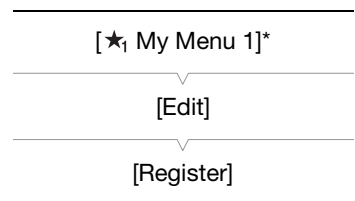

Rearranging Menu Settings

- 1 Open the My Menu [Move] screen.
[★, My Menu 1]* ➡ [Edit] ➡ [Move]
- 2 Push the joystick up/down or turn the SELECT dial to select the setting you want to move and then press SET.

- An orange ⬆ icon will appear next to the setting you selected to move.

- 3 Push the joystick up/down or turn the SELECT dial to move the setting to the desired position and then press SET.

* Default setting. You can select a different My Menu set in advance.

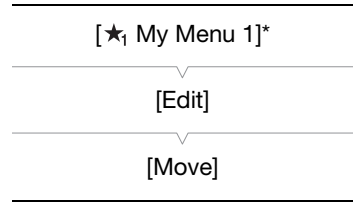

Removing Menu Settings

- 1 Open the My Menu [Delete] screen.
[★, My Menu 1]* ➡ [Edit] ➡ [Delete]
- 2 Push the joystick up/down or turn the SELECT dial to select the setting you want to remove and then press SET.
- 3 Select [OK] and then press SET twice.

* Default setting. You can select a different My Menu set in advance.

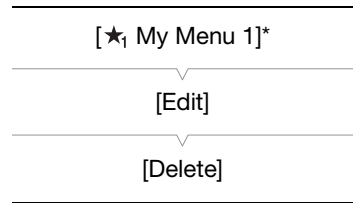

Resetting the My Menu Submenu

- 1 Reset all the menu settings registered to the currently selected My Menu set.
[★, My Menu 1]* ➡ [Edit] ➡ [Reset All]

- 2 Select [OK] and then press SET twice.
- * Default setting. You can select a different My Menu set in advance.

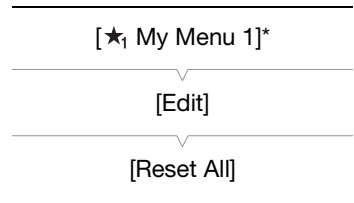

Renaming the Selected My Menu Set

You can give each of the 3 My Menu sets a more descriptive name to make them easier to identify.

- 1 Open the My Menu [Rename] screen.
[★, My Menu 1]* ➡ [Edit] ➡ [Rename]
- 2 Select [Input] and then press SET.
 - Enter the desired name (8 characters long) using the keyboard screen (📖 35).
- 3 Select [OK] and then press SET.

* Default setting. You can select a different My Menu set in advance.

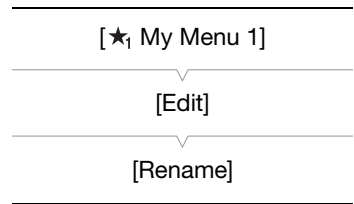

Using the Virtual Keyboard Screen

When the monitor unit is attached to the camera and the LCD screen is used, the full keyboard screen will appear on the screen. When the monitor unit is not attached to the camera, a simplified screen for entering text will appear on the viewfinder.

1 Use the joystick to select a character and then press SET to add it.

- On the full keyboard: Push the joystick up/down/left/right to select the desired character and press SET to enter it. Use the arrows (↑/↓/←/→) to change the position of the cursor and the backspace character (←X) to delete the last character entered. You can also press the MENU button to delete the last character.

On the simplified screen: Push the joystick up/down or turn the SELECT dial to select the desired character and press SET to enter it. Press the MENU button to delete the last character.

- If you are entering sensitive information, like a password, the character you entered will change to "●" after a moment to protect the password.
- Repeat this step as necessary to enter the desired text.

2 After entering the desired text, select [OK] in the full keyboard, or [Set] in the simplified screen, and then press SET to close the keyboard screen.

Full keyboard on the LCD screen



Current character / Character limit

Simplified screen

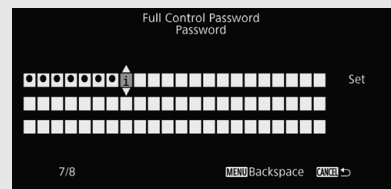

Preparing the Camera

This section outlines the basic preparations for the camera such as attaching a lens and attaching the modular units to the camera: grip unit, bracket and handle unit, thumb rest, eye cup, etc.

Preparing the Lens

As much as possible, attach and remove the lens quickly and in a clean environment free of dust. Refer also to the instruction manual of the lens used.

! IMPORTANT

- When attaching/removing a lens, avoid direct sunlight or strong light sources. Also, be careful not to drop the camera or lens.

i NOTES

- After removing a lens/When a lens is not attached to the camera:
 - Do not touch the lens's surfaces, the lens mount or any components inside the lens mount area.
 - Replace the body cap to the lens mount and the dust caps to the lens. Clean any dust or dirt from the body cap and dust caps before using them.

Attaching an EF Lens

- 1 Set the **POWER** switch to OFF.
- 2 Remove the body cap from the camera and the dust caps from the lens.
- 3 Attach the lens to the camera and turn the lens in the direction of the arrow until it clicks in place.
 - EF lenses: Align the red mark on the lens with the red EF Lens mount index mark on the camera.
 - EF-S lenses: Align the white mark on the lens with the white EF-S Lens mount index mark on the camera.

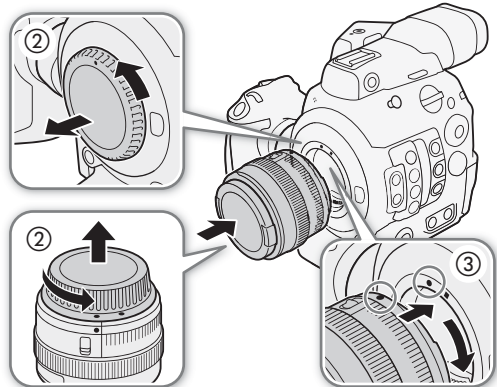



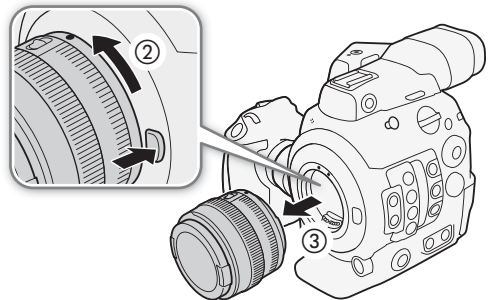

Removing an EF Lens

- 1 Set the **POWER** switch to OFF.
- 2 Hold down the lens release button and turn the lens all the way in the direction of the arrow until it stops.
- 3 Remove the lens and replace the body cap on the camera and the dust caps on the lens.



i NOTES





- Turning on the image stabilization function of an EF lens may reduce the effective usage time of the battery pack. When image stabilization is not necessary, for example if the camera is fixed to a tripod, it is recommended to turn it off.

- Depending on the lens used, you may experience one or more of the following limitations.
 - The lens model name may be shortened when displayed on the screen.
 - You may not be able to focus manually when the focus mode switch is set to AF.
 - You may not be able to use the focus preset function on super telephoto lenses.
- This camera's sensor is larger than the sensor size for which EF-S lenses are designed (APS-C). When using EF-S lenses with this camera, you may notice peripheral illumination fall-off or vignetting.
- You cannot use the power zoom function on lenses with that function.
- When using a compatible lens, you can use the [ System Setup]  [Custom Function]  [Retract Lens] setting ( 144) to retract the lens automatically when the camera's power is turned off.

In-Camera Lens Correction

Depending on the characteristics of the lens used, the corners of an image frame may be darker than the center due to light fall-off (peripheral illumination drop), or color shift/color fringing may be visible along high-contrast edges in the image (chromatic aberration). If the camera has correction data available for the EF lens used, it can apply this correction data to compensate as necessary.

Operating modes: CAMERA MEDIA

- 1 Attach the lens you want to use.
- 2 Open the desired correction screen.
 - [ Camera Setup]  [Periph. Illum. Corr.] or [Chromatic Aberr. Corr.]
 - If correction data is not available, the corresponding menu option will appear grayed out. Visit your local Canon Web site and check if there is correction data available for the lens you are using. If so, download the necessary update package and upgrade the camera's firmware following the instructions supplied therein.
- 3 Select [On] and then press SET.
 - As long as [ Camera Setup]  [Periph. Illum. Corr.] or [Chromatic Aberr. Corr.] is set to [On], the camera will automatically apply the appropriate correction data.

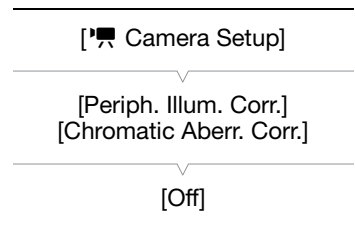

NOTES

- **About in-camera lens correction data:** The camera contains a register of correction data for compatible lenses that were available at the time the camera went on sale. Correction data for future lenses will be made available as part of the regular updates released for the camera's firmware. For more details, visit your local Canon Web site.
- No peripheral illumination/chromatic aberration correction will be applied in the following cases:
 - When the appropriate correction data is not available for the lens attached.
 - When using non-Canon lenses. Even if the corresponding menu setting is available (not grayed out), setting it to [Off] is recommended.

- When peripheral illumination correction is activated:
 - Depending on the recording conditions, noise may appear in the periphery of the image as a result of the correction.
 - The level of correction will be lower for lenses that cannot provide distance information.
 - The level of correction will be lower the higher the ISO speed/gain setting used.
 - Due to the difference in sensor size, when using EF-S lenses, peripheral illumination fall-off may be more pronounced.

Updating the Firmware of an EF Lens

You can update the lens firmware of the EF lens attached to the camera. For details about firmware updates for EF lenses, visit your local Canon Web site.

Operating modes: CAMERA MEDIA

1 Download the lens firmware update file from the Canon Web site and save it on an SD card. Insert the SD card containing the lens firmware update into the SD card slot.

2 Attach the lens you wish to update to the camera and open the lens firmware submenu.

[ System Setup] ➤ [Firmware] ➤ [Lens]

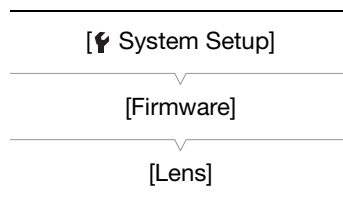

Configuring the Modular Units

Your camera is nothing if not versatile and you can choose the configuration that best fits your needs and shooting conditions.

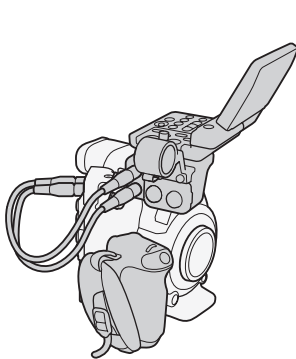
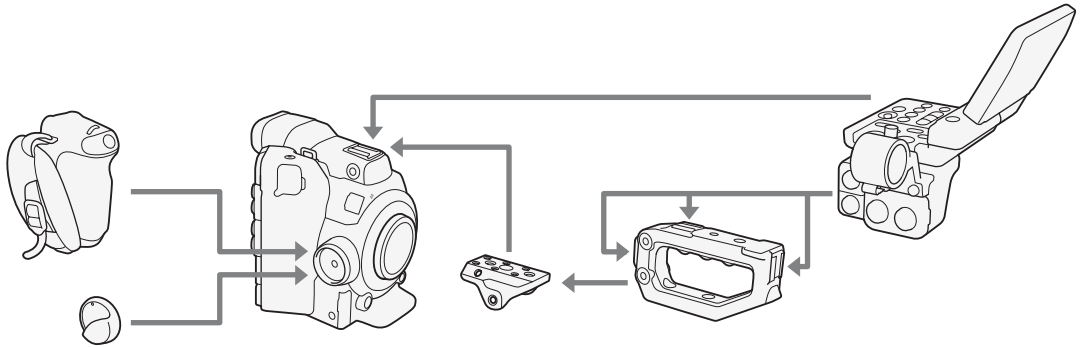

Configuration with monitor

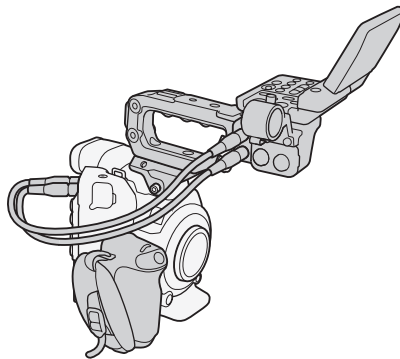

Configuration with monitor, bracket and handle for easy carrying

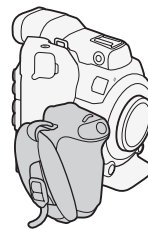

Light configuration with grip for hand-held shooting

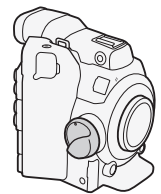

Minimal configuration with thumb rest

! IMPORTANT

- Be careful not to drop the camera or modular units when attaching, removing or adjusting the various accessories. Use a table or other stable surface to change the camera's configuration.

i NOTES

- You can use the optional RD-1 Rod Clamp to use the camera with a commercially available viewfinder or other accessories with a \varnothing 15 mm (0.59 in.) rod.

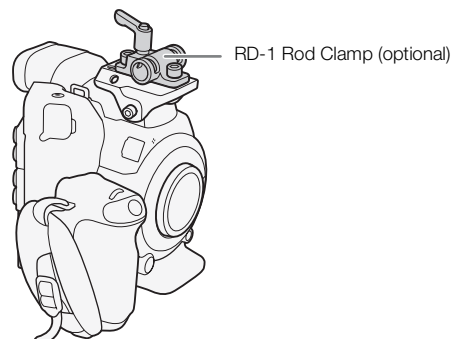

Using the Viewfinder

The camera's viewfinder features an OLED screen that turns on automatically when you look through the viewfinder. The screen also turns off automatically shortly after you stop using the viewfinder.

Adjusting the Viewfinder

- 1 Gently pull out the viewfinder until it stops and adjust the angle as necessary.
- 2 Turn on the camera and adjust the dioptic adjustment lever until the viewfinder's image is sharp.

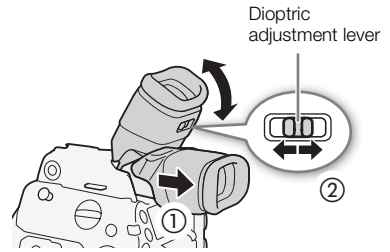

i NOTES

- You can turn on the viewfinder permanently by setting [**Picture/Terminals Setup**] ➤ [**Viewfinder Setup**] ➤ [**Eye Sensor**] to [Off].

Attaching and Removing the Eye Cup

Attach the eye cup so that it covers the rubber rim of the viewfinder unit. To remove the eye cup, pull it gently in a “peeling off” motion from the bottom up.

- For left eye use, attach the eye cup so that the protruding part faces the opposite side.

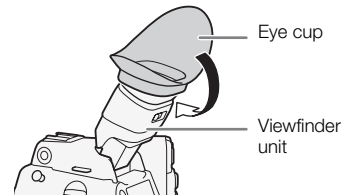

! IMPORTANT

- Pointing the viewfinder lens at the sun or other strong light sources may cause damage to internal components. When you are not using the viewfinder, make sure to attach the viewfinder cap to the viewfinder. This will also protect the viewfinder from scratches and dirt. Attach the viewfinder cap by inserting it into the rubber rim of the viewfinder unit.

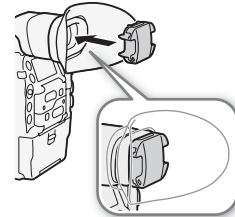

Using the LCD Panel

The whole monitor unit can be rotated 270° sideways allowing for easy monitoring and operation from the side of the camera. Additionally, the independently articulated LCD panel can be rotated 180° sideways and 270° up and down. In combination, you can position the LCD panel at a comfortable angle whatever the shooting style you need.

- 1 Rotate the monitor unit sideways to the desired angle.
- 2 Open the LCD panel and adjust the screen to the desired position.

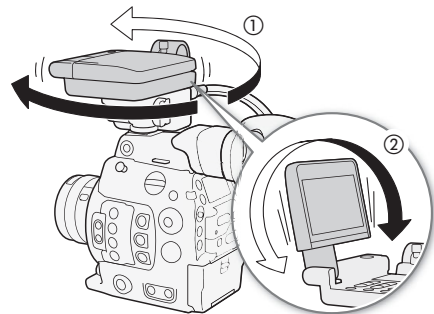

Adjusting the LCD Panel for Shoulder Mounted Use

- 1 Open the LCD panel 90° until it is perpendicular to the monitor unit.
- 2 Rotate the LCD panel 180° left.
- 3 Rotate the LCD panel 180° forward.
- 4 Press the MIRROR button until the image is displayed in the correct orientation.
 - Repeatedly pressing the MIRROR button will change the displayed image in the following order: Image inverted horizontally → Image inverted horizontally and vertically → Image inverted vertically → Original image.

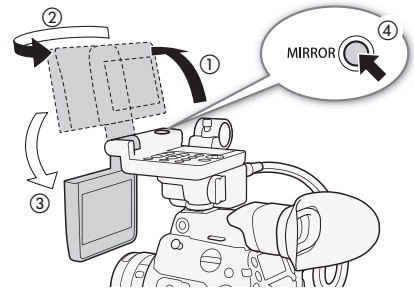

You can use the viewfinder and watch the LCD screen at the same time

i NOTES

- Using the handle unit (44), you can attach the monitor unit in a number of different positions for maximum flexibility by attaching it to the front, top or rear accessory shoe.
- When you use a commercially available lens adapter and the image on the screen is inverted, you can use the [F System Setup] ➤ [Custom Function] ➤ [Scan Reverse Rec] setting (144) to return the image to the correct orientation.
- You can turn off the LCD screen by setting [Picture/Terminals Setup] ➤ [Select Monitoring Devices] to an option that does not include [LCD].
- **About the LCD and viewfinder screens:** The screens are produced using extremely high-precision manufacturing techniques, with more than 99.99% of the pixels operating to specification. Very rarely, pixels may misfire or may light up permanently as white dots. This has no effect on the recorded image and does not constitute a malfunction.

Adjusting the Viewfinder/LCD Screen

You can adjust the brightness, contrast, color, sharpness, and luminance level of the viewfinder and LCD screen independently of each other. These adjustments will not affect your recordings.

Operating modes: CAMERA MEDIA

- 1 Open the setup menu for the viewfinder or LCD screen.
[Picture/Terminals Setup] ➤ [LCD Setup] or [Viewfinder Setup]
- 2 Select [Brightness], [Contrast], [Color], [Sharpness], [Backlight]* or [Luminance]** and then press SET.
- 3 Select the desired level and then press SET.
 - Repeat steps 2 and 3 to adjust other settings as necessary.

[Picture/Terminals Setup]

[LCD Setup] [Viewfinder Setup]

[Brightness] ±0
 [Contrast] ±0
 [Color] ±0
 [Sharpness] 2
 [Backlight]* [Normal]
 [Luminance]** [Normal]

* [LCD Setup] only.
 ** [Viewfinder Setup] only.

i NOTES

- If you set an assignable button to [LCD Setup] or [Viewfinder Setup] (131), you can press the button to open the respective submenu.

Setting the Screen to Black & White

The viewfinder and LCD screen display in color by default but you can set them to black & white. Even when the screen is black & white, onscreen text and icons will still be displayed in color.

Operating modes: CAMERA MEDIA

- 1 Open the display selection menu for the viewfinder or LCD screen.
 - [Assistance Functions] ➤ [B&W Image] ➤ [Display on LCD] or [Display on VF]
- 2 Select [On] and then press SET.
 - You can also change the video output from the MON. and HDMI OUT terminals (together) to black & white.
 - Repeat steps 1 and 2 as necessary to select other screens/video outputs.
- 3 Open the B&W image's [Activate] submenu.
 - [Assistance Functions] ➤ [B&W Image] ➤ [Activate]
- 4 Select [On] and then press SET.

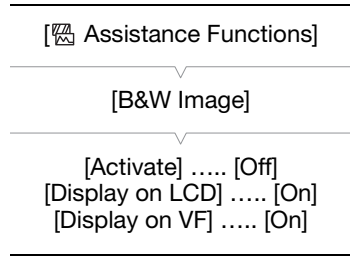

Using a Tripod

The camera is shipped with the TB-1 Tripod Base for tripods with 0.95 cm (3/8") screws. You can mount the camera on a tripod but do not use tripods with mounting screws longer than 5.5 mm (0.2 in.) as this may cause damage to the camera.

Using a Tripod with 0.64 cm (1/4") Mounting Screws

To use a tripod with 0.64 cm (1/4") mounting screws, first attach the supplied tripod adapter base to the camera and then attach the tripod to the adapter base.

- 1 Remove the original TB-1 Tripod Base from the camera.
 - Remove the 4 screws and then remove the base.
- 2 Attach the supplied tripod adapter base for 0.64 cm (1/4") tripods.
 - Firmly screw in the 4 screws.
- 3 Attach the tripod.
 - Firmly screw in the tripod screw.

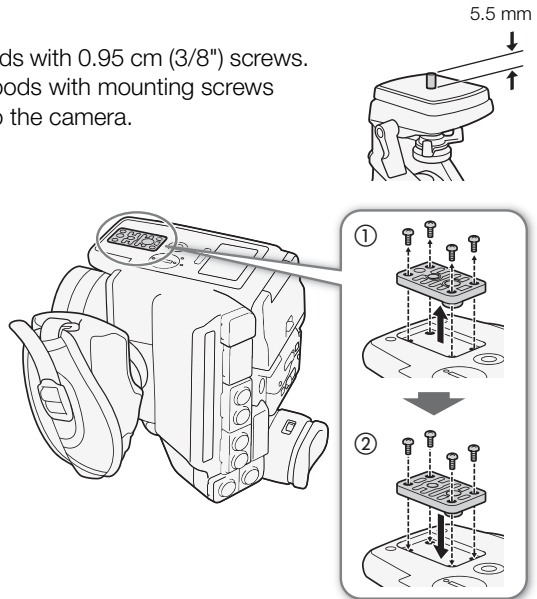

Removing and Attaching the Grip Unit

The grip unit comes originally attached to the camera. You can remove it and replace it with the thumb rest should the minimal configuration be necessary.

Removing the Grip Unit

- 1 Set the **POWER** switch to OFF.
- 2 Unscrew the grip unit's lock screw and gently detach the grip unit.
 - The grip unit contains an internal connection cable so be sure not to pull it too forcefully.
- 3 Disconnect the grip unit's connection plug.
- 4 Screw the thumb rest onto the camera.

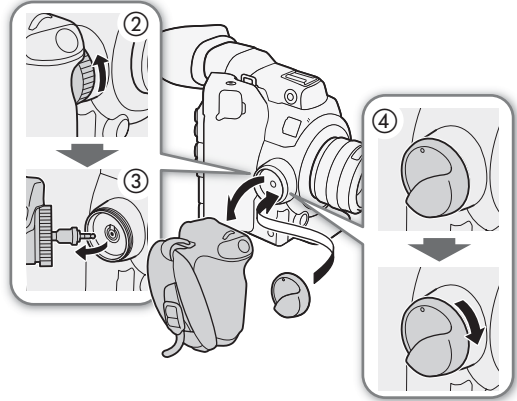

Attaching the Grip Unit

The grip unit can be attached in any of 24 positions (at 15° intervals) to give you a convenient grip angle for high- and low-angle shooting.

- 1 Set the **POWER** switch to OFF.
- 2 Unscrew the thumb rest and remove it from the camera.
- 3 Firmly insert the grip unit's plug all the way into the grip unit connection terminal on the camera.
 - Make sure to insert the plug all the way in, until the white line around the terminal is not visible.
 - If the plug is not correctly connected (for example, if the white line around the terminal is partly visible), all the controls on the camera may be disabled.
- 4 Attach the grip unit to the camera aligning it at the desired angle and tighten the grip unit's lock screw.

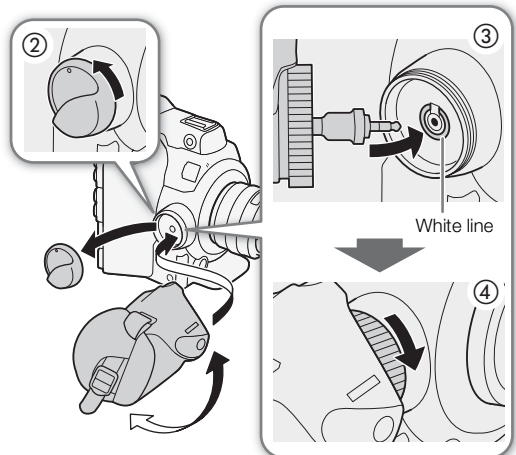

Adjusting the Grip Belt

Adjust the grip belt so that you can reach the START/STOP button on the grip unit with your index finger but still have a comfortable but secure grip.

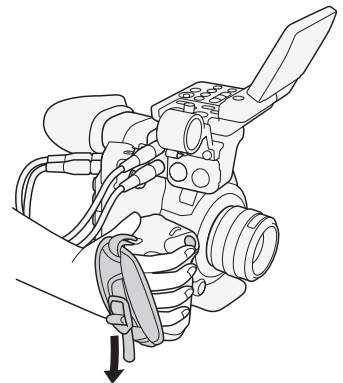

Attaching the Handle Unit

- 1 Attach the mounting bracket to the camera.
 - Use the supplied hex wrench to secure the bracket firmly with 3 of the supplied hex socket head screws.
- 2 Attach the handle unit to the mounting bracket.
 - Secure the handle unit firmly with 2 of the supplied hex socket head screws.

i NOTES

- The handle unit has 0.95 cm (3/8") and 0.64 cm (1/4") sockets and the mounting bracket has additional 0.64 cm (1/4") sockets, giving you multiple options to attach a variety of commercially available accessories.

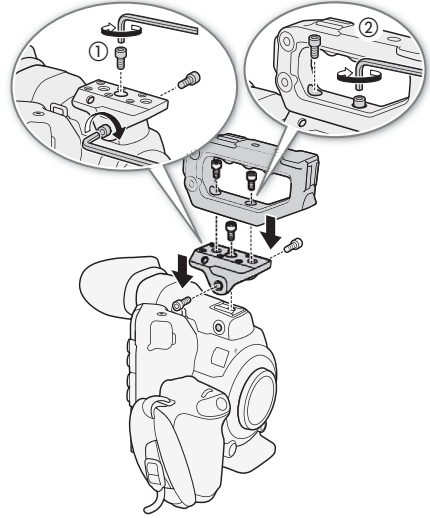

Attaching the Shoulder Strap

Pass the ends through the strap mount and adjust the length of the strap.

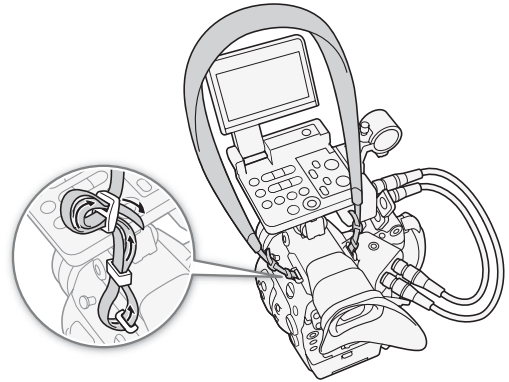

Removing and Attaching the Terminal Covers

You can remove the covers of the camera's terminals to access them more easily.

Removing the Terminal Covers

Open the terminal cover and gently pull it straight out.

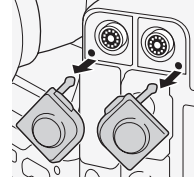

Attaching the Terminal Covers

Insert the connecting strip into the opening to attach the terminal cover.

NOTES

- If the connecting strip is difficult to grasp, use a pair of tweezers or similar tool.

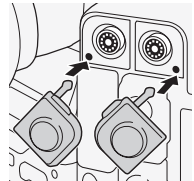

Preparing Recording Media

The camera records 4K clips on CFast cards and 2K or Full HD clips (proxy clips) and photos on SD cards*. The camera features two CFast card slots. When you insert two CFast cards in the camera, the camera can record 4K clips simultaneously on both cards, or it can switch automatically to recording on the other CFast card when a CFast card becomes full.

Initialize recording media (📖 49) when you use them with this camera for the first time.

* The SD card is used also to save custom picture files, menu settings files and user memo files created with the Canon XF Utility for XF-AVC software (📖 170) for later use on the camera.

Compatible Recording Media

The following types of memory card can be used with this camera. For the latest information about recording media tested for use with this camera, visit your local Canon Web site.

CFast cards

CFast 2.0-compliant cards.

SD cards*

SD card type:			
	SD cards	SDHC cards	SDXC cards
SD Speed Class**:			

* As of July 2015, the clip recording function has been tested using SD cards made by Panasonic, Toshiba and SanDisk.

** SD Speed Class is a standard that indicates the minimum guaranteed data transfer rate of SD cards.

! IMPORTANT

- After repeatedly recording, deleting and editing clips (if the memory is fragmented), you may notice slower writing speeds to the recording media and recording may even stop. In such case, save your recordings and initialize the recording media with the camera.
- **About CFast and SDXC cards:** You can use CFast and SDXC cards with this camera but these types of cards are initialized by the camera using the exFAT file system.
 - When using exFAT-formatted cards with other devices (digital recorders, card readers, etc.), make sure that the external device is compatible with exFAT. For more information on compatibility, contact the computer, operating system or memory card manufacturer.
 - If you use exFAT-formatted cards with a computer OS that is not exFAT-compatible, you may be prompted to format the card. In such case, **cancel the operation to prevent data loss.**

i NOTES

- Proper operation cannot be guaranteed for all recording media.

Inserting a CFast Card

You can insert a CFast card into CFast card slot A or slot B. If you have two CFast cards, you can use both slots.

Operating modes: CAMERA MEDIA

- 1 Slide the CFast card slot cover switch in the direction of the arrow.
 - The CFast card slot cover will open upward (slot A) or downward (slot B).
- 2 Insert the CFast card straight, with the label facing up, all the way into the slot.
- 3 Close the CFast card slot cover.
 - Do not force the cover closed if the CFast card is not correctly inserted.

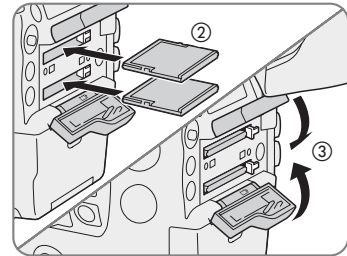
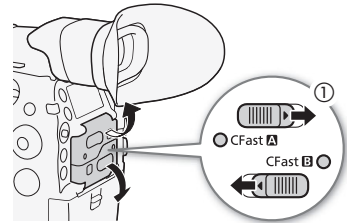

CFast card access indicators

CFast [A]/CFast [B] indicator	CFast card status
Red	Accessing the CFast card.
Green	Recording/playback is possible and the CFast card slot is selected for recording/playback.
Off	A CFast card is not inserted or the CFast card slot is not currently selected.

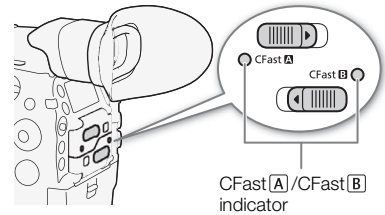

If you set [System Setup] [Media Access LED] to [Off], the card access indicators will not illuminate.

Removing a CFast card

Operating modes: CAMERA MEDIA

- 1 To remove the CFast card currently selected, wait until the CFast card access indicator is illuminated in green.
 - A CFast card not currently selected (CFast card access indicator is off) can be removed at any time.
- 2 Slide the CFast card slot cover switch in the direction of the arrow.
 - The CFast card slot cover will open upward (slot A) or downward (slot B).
- 3 Push the CFast card release button.
- 4 Pull out the CFast card and close the CFast card slot cover.

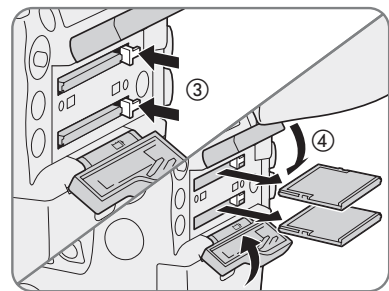

! IMPORTANT

- Observe the following precautions while a CFast card access indicator is illuminated in red. Failure to do so may result in permanent data loss.
 - Do not disconnect the power source or turn off the camera.
 - Do not open the cover of the CFast card slot being accessed.

Inserting and Removing an SD Card

Operating modes: CAMERA MEDIA

- 1 Wait until the SD card access indicator is off or is illuminated in green.
 - To remove the SD card, push the SD card once to release it. When the SD card springs out, pull it all the way out.
- 2 Open the SD card slot cover.
- 3 Insert the SD card, with the label facing the grip unit, all the way into the SD card slot until it clicks.
 - To remove the SD card, push the SD card once to release it. When the SD card springs out, pull it all the way out.
- 4 Close the SD card slot cover.
 - Do not force the cover closed if the SD card is not correctly inserted.

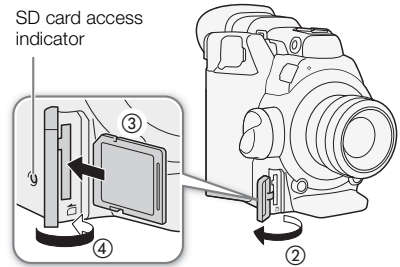

SD card access indicator

SD card access indicator	SD card status
Red	Accessing the SD card.
Green	Proxy clip recording is activated and the SD card is ready for recording, or playback of proxy clips and photos is possible.
Off	An SD card is not inserted, the SD card is not being accessed, or the SD card is write-protected with the LOCK switch.

If you set [f System Setup] ➤ [Media Access LED] to [Off], the card access indicators will not illuminate.

! IMPORTANT

- Observe the following precautions while the SD card access indicator is illuminated in red. Failure to do so may result in permanent data loss.
 - Do not disconnect the power source or turn off the camera.
 - Do not remove the SD card.
- SD cards have front and back sides that are not interchangeable. Inserting an SD card facing the wrong direction can cause a malfunction of the camera. Be sure to insert the SD card as described in step 3.

i NOTES

- SD cards have a physical switch to prevent writing on the card so as to avoid the accidental erasure of the card's content. To write-protect the SD card, set the switch to the LOCK position.

Initializing Recording Media

The first time you use a recording media with this camera, initialize it first. You can also initialize a recording media to permanently delete all the data it contains.

When initializing an SD card, you can select quick initialization, which clears the file allocation table but does not physically erase the stored data, or complete initialization, which deletes all data completely.

Operating modes: CAMERA MEDIA

1 Open the [Initialize Media] submenu.

[ Recording/Media Setup]  [Initialize Media]

[ Recording/Media Setup]

[Initialize Media]

2 Select [CFast A], [CFast B] or [SD Card] and then press SET.

To initialize a CFast card

3 Select [OK] and then press SET.

4 When the confirmation message appears, press SET.

- The CFast card is initialized and all the data it contains is erased.

To initialize an SD card

3 Select [Complete] (complete initialization) or [Quick] (quick initialization) and then press SET.

4 Select [OK] and then press SET.

- If you are using the [Complete] initialization option, press SET twice to cancel the operation while it is in progress. You can use the SD card but all data will be erased.

5 When the confirmation message appears, press SET.

- The SD card is initialized and all the data it contains is erased.

IMPORTANT

- Initializing a recording media will permanently erase all data, including clips with an **OK** mark, photos and protected custom picture files. Lost data cannot be recovered. Make sure you save important recordings in advance.
- Depending on the SD card, the complete initialization may take up to a few minutes.

NOTES

- While recording on a CFast card, you can initialize another CFast card in the other CFast card slot.
- If you set an assignable button to [Initialize Media] ( 131), you can press the button to open the initialization submenu.

Switching Between the CFast Card Slots

The camera features two CFast card slots, CFast **A** (CFast card slot A) and CFast **B** (CFast card slot B). If both slots contain a CFast card, you can switch between them as necessary.

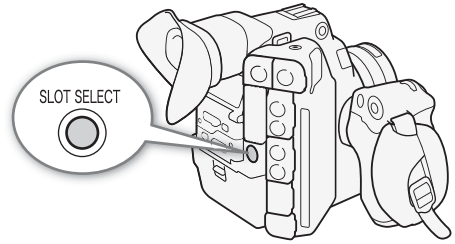

Operating modes: **CAMERA** **MEDIA**

Press the **SLOT SELECT** button.

- The access indicator of the selected CFast card slot will illuminate in green. On the screen, the CFast card selected is indicated with a **▶** mark next to CFast card icon and in the rear panel, with a **▼** mark on top of the CFast card icon.

i NOTES

- If both CFast card slots contain a CFast card and you open the cover of the selected slot, the camera will automatically switch to the other slot.
- You cannot use the SLOT SELECT button to switch between CFast card slots while recording.
- You can also perform this function remotely using Browser Remote on a connected Wi-Fi device (📖 120, 122).

Relay Recording and Double Slot Recording

The camera features two convenient recording methods that can be used when both CFast card slots contain a CFast card: relay recording and double slot recording.

Relay recording: This function allows you to continue recording on another CFast card without interruption if the CFast card you are using becomes full. Relay recording is available from CFast card slot A to CFast card slot B, and vice versa.

Double slot recording: This function records the same clip simultaneously to both CFast cards, which is a convenient way to make a backup copy of your recording while you record.

Operating modes: **CAMERA** **MEDIA**

To use relay recording

- 1 Open the [Relay Recording] submenu.
 [🔧 Recording/Media Setup] ➤ [Relay/Double Slot Rec] ➤ [Relay Recording]
- 2 Select [On] and then press SET.

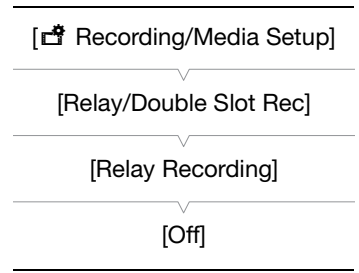

To use double slot recording

- 1 Open the [Double Slot Recording] submenu.
 [🔧 Recording/Media Setup] ➤ [Relay/Double Slot Rec] ➤ [Double Slot Recording]
- 2 Select [On] and then press SET.
 - **D** appears at the top of the screen.

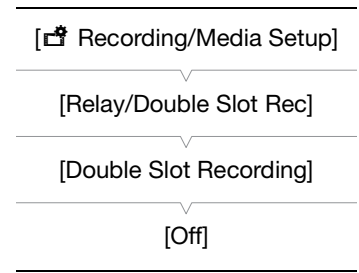

NOTES

- Relay recording (the switch to the other CFast card) will not be performed during slow motion recording even if the recording media becomes full.
- If a CFast card becomes full during double slot recording, recording on both cards will stop. On the other hand, if an error occurs with one of the CFast cards, recording will continue on the other card.
- Double slot recording cannot be used with relay recording or slow & fast motion recording.

Checking the Remaining Recording Time on Recording Media

In **CAMERA** mode, the display on the upper left of the screen shows the recording media icons and the remaining recording time¹ (in minutes) on each card (☞ 56). The information for the currently selected CFast card is displayed also on the rear panel. In **MEDIA** mode, the icon of the recording media currently selected will appear in white on the screen (☞ 150). Only the icon of the recording media currently selected is displayed also on the rear panel.

On the [Media] status screen (☞ 195), you can check the total space, used space, and remaining recording time^{1, 2} on each recording media. For SD cards only, the remaining number of photos² and SD speed class are displayed as well.

¹ The approximate available recording time is based on the current bit rate (☞ 62).

² Remaining recording times and the remaining number of photos appear on the status screen only in **CAMERA** mode.

Recovering Clips

Some actions, such as suddenly turning off the camera or removing the recording media while data is being recorded, can cause data errors in the recorded clip. If when you open an index screen in **MEDIA** mode, a message is displayed indicating that clips need recovering, you may be able to recover clips with data errors with the following procedure.

Operating modes: **CAMERA** **MEDIA**

- 1 Open the index screen with the clip you wish to recover (☞ 147).
- 2 Select the desired clip (a clip with the ? icon instead of a thumbnail image) and then press SET.
- 3 Select [Recover Clip] and then press SET.
- 4 Select [OK] and then press SET.
 - The camera will attempt to recover the corrupted data.
- 5 When the confirmation message appears, press SET.

NOTES

- This procedure may delete clips shorter than 0.5 seconds in length. Additionally, up to 0.5 seconds may be deleted from the end of clips.
- In some cases, it may not be possible to recover the data. This is more likely when the file system is corrupted or the recording media is physically damaged.
- Only clips recorded with this camera can be recovered. Photos and still frame image files cannot be recovered.

Adjusting the Black Balance

You can have the camera adjust the black balance automatically when ambient temperature changes considerably or if there is a noticeable change in a true black video signal.

Operating modes: CAMERA MEDIA

1 Attach the body cap to the lens mount.

- If a lens was attached, remove the lens and replace the body cap.

2 Open the [ABB] screen.

[Camera Setup] [ABB]

[Camera Setup]

[ABB]

3 Select [OK] and then press SET.

- The automatic black balance procedure will start. It will take approximately 40 seconds when the frame rate is set to 23.98P or 24.00P.

4 When the confirmation message appears, press SET.

- If the sensor is not completely shielded from light, [Error] will appear on the screen. Press SET and repeat the procedure from the beginning.

NOTES

- Adjusting the black balance is necessary in the following cases:
 - When using the camera for the very first time or after a long period of not using it.
 - After sudden or extreme changes in ambient temperature.
 - After changing the ISO speed/gain settings.
 - After resetting all the camera's settings.
- During the adjustment of the black balance, you may notice some irregular displays appear on the screen. This is not a malfunction.

Recording Video

This section explains the basics of recording clips*. For details on recording audio, refer to *Recording Audio* (□ 96).

Before making important recordings for the first time, make the following test recordings to check that the camera operates correctly. Should the camera fail to operate correctly, refer to *Troubleshooting* (□ 199).

- Record a primary clip on a CFast card for approximately 5 minutes using the default bit rate of 410 Mbps.
- Change the frame rate (□ 62) to 59.94P or 50.00P, activate the simultaneous recording of proxy clips (□ 111) and record a proxy clip on an SD card for approximately 20 minutes.

* "Clip" refers to a single movie unit recorded with a single recording operation. You can also include custom picture settings (□ 134) and metadata (□ 106) with the clip.

Operating modes:

Preparing to Record

- 1 Attach the monitor unit, handle unit, grip unit, etc. as necessary to build the desired configuration (□ 39).
- 2 Attach a charged battery pack to the camera (□ 26).
- 3 Insert recording media (one or two CFast cards, SD card) as necessary (□ 47, 48).
 - Insert CFast cards into both CFast card slots to use relay recording or double slot recording (□ 50).
 - Insert an SD card to record proxy clips (□ 111) (and/or photos).
 - To use an external recorder (□ 163), complete the necessary connections and settings.
- 4 Attach a lens (□ 36).
- 5 Adjust the viewfinder and/or LCD screen.

NOTES

- The camera can add a user memo (□ 106) to the clips. It can be used to store information such as the clip name, camera operator and filming location. However, you must set the user memo before recording.

Recording

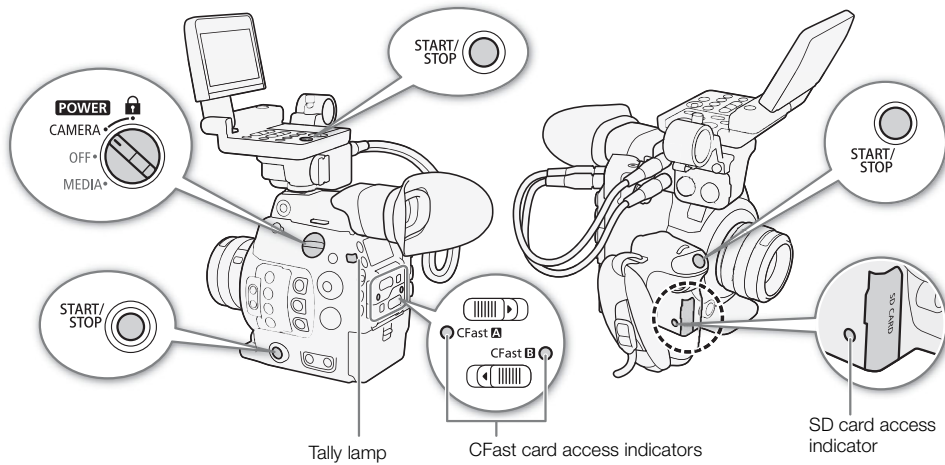

1 Set the **POWER** switch to **CAMERA**.

- The camera turns on in **CAMERA** mode and enters record standby mode.
- The access indicators of card slots with a card inserted will illuminate momentarily in red. Then, the access indicator of the CFast card slot selected for recording will change to green.

2 Press the **START/STOP** button to begin recording.

- Recording starts. The tally lamp illuminates and the recording indicator [●REC] appears at the top of the screen.
- You can use the **START/STOP** button on the camera's body (left side), the grip unit or the monitor unit.
- You can also perform this function remotely using Browser Remote on a connected Wi-Fi device (📖 120, 122).
- For details about recording proxy clips, refer to *Simultaneous Recording of Proxy Clips* (📖 111).

3 Press the **START/STOP** button to stop recording.

- The clip is recorded to the CFast card and the camera enters record standby mode. The tally lamp will also go out.

! IMPORTANT

- Observe the following precautions while an access indicator is illuminated in red. Failure to do so may result in permanent data loss.
 - Do not open the card slot cover of the card being accessed and do not remove the card.
 - Do not disconnect the power source or turn off the camera.
- Be sure to save your recordings regularly (📖 170), especially after making important recordings. Canon shall not be liable for any loss or corruption of data.

i NOTES

- You can use the review function (📖 110) to play back part or all of the last clip recorded without having to switch to **MEDIA** mode.
- If you record using the custom picture and metadata settings, those settings will be recorded with the clip. For more details, refer to *Custom Picture Settings* (📖 134) and *Using Metadata* (📖 106).
- If the camera switches to the other CFast card while recording video due to the relay recording function (📖 50), the two parts (before/after the switch) will be recorded as separate clips.
- If you set an assignable button to [Add Shot Mark 1] or [Add Shot Mark 2] (📖 131), you can press the button to add a shot mark to a clip while it is being recorded. If you set an assignable button to [Add **OK** Mark] or [Add **✓** Mark] (📖 131), you can press the button to add an **OK** mark or **✓** mark to the last clip recorded.

Locking the Controls in Recording Mode

Once in **CAMERA** mode, you can set the **POWER** switch to **LOCK** (key lock) to lock all the physical controls (buttons and switches) on the camera, save for the START/STOP button*. This is useful in preventing settings from being changed due to inadvertently pressing one of the buttons. Return the **POWER** switch to the **CAMERA** position to reactivate the controls.

* You can also choose to lock all or some of the START/STOP buttons with the [f System Setup] [Custom Function] [START/STOP Button] setting (144). In either case, you can still operate the camera using the Browser Remote application (120).

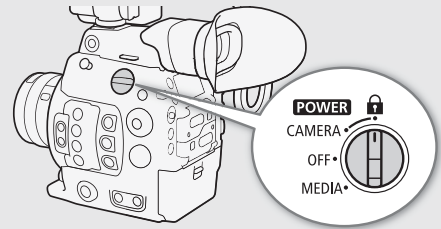

Onscreen Displays

Refer to this section for an explanation of the various screen displays that appear in **CAMERA** mode. You can use the custom display function (145) to turn off individual onscreen displays if they are not required. The menu item that controls each display is given in the following table (1: indicates a menu item under [Custom Display 1] and 2: indicates a menu item under [Custom Display 2]).



AF frames

Depending on the focus function used you may see some of the following AF frames.

Continuous AF frame – always in white (82)

AF-Boosted MF frame – in yellow: manual adjustment range; in white: automatic adjustment range (81)

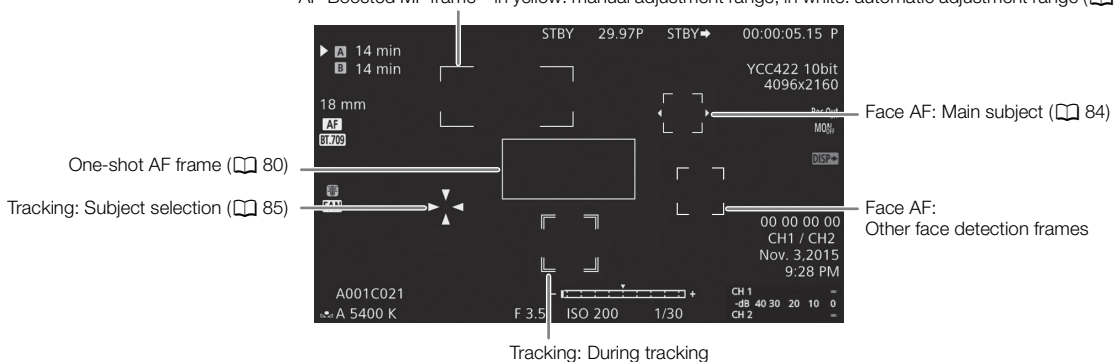

Tracking: During tracking

Left side of the screen

Icon/Display	Description	Custom Display
→ → → (in red) 000 min	Remaining battery charge The icon shows an estimate of the remaining charge. The remaining recording time is displayed, in minutes, next to the icon. <ul style="list-style-type: none"> When is displayed, replace the battery pack with a fully charged one. Depending on the conditions of use, the actual battery charge may not be indicated accurately. 	2: [Remaining Battery]
Recording media status and estimated remaining recording time		2: [Remaining Rec Time]
	CFast card status: in green - can record; in white - reading the CFast card. The CFast card selected for recording is indicated with a mark.	
	No CFast card or cannot record on the CFast card.	
	SD card status: in green - can record (proxy clips); in yellow - the SD card is almost full.	
	No SD card or cannot record on the SD card.	
000 mm	Approximate focal length of the lens	1: [Focal Length]
	Focus mode (77)	1: [Focus Mode]
	Face AF (84)	
	Preset custom picture settings (134)	1: [Custom Picture]
	Detailed settings in the [Other Settings] submenu of the custom picture file are active (139).	1: [Custom Picture]
	Light metering mode (73)	1: [Light Metering]
	Temperature warning (61)	2: [Temperature/Fan]
	Fan operation (61)	2: [Temperature/Fan]
	Lens error warning (201)	1: [Lens]
	Lithium button battery not inserted (28)	–

Top of the screen

















Icon/Display	Description	Custom Display
Network functions:		2: [Network Functions]
	Network connection status: in white - function ready to be used; in yellow - connecting to or disconnecting from a network. For details, refer to the 'WFT-E6: Guide for EOS C300 Mark II Users' (PDF file).	
	Record selected onscreen displays with primary clips (144)	2: [OSD Recording]
	Double slot recording (50)	2: [Recording Mode]

Icon/Display	Description	Custom Display
Recording operation:		2: [Recording Mode]
STBY, ● REC	Clip recording: record standby, recording.	
INT STBY, ● INT, ● INT REC	Interval recording (☐ 117): record standby (before the sequence has started), record standby (once the sequence has started), recording. • In record standby mode before the interval recording sequence has started, [INT] flashes.	
FRM STBY, ● FRM STBY, ● FRM REC	Frame recording (☐ 116): record standby (before the sequence has started), record standby (once the sequence has started), recording. • In record standby mode before the frame recording sequence has started, [FRM] flashes.	
S&F STBY, ● S&F REC	Slow & fast motion recording (☐ 113): record standby, recording.	
PRE REC STBY, ● PRE REC	Pre-recording (☐ 115): record standby, recording.	
1s - 10m00s	Interval recording counter (☐ 117)	2: [Interval Counter]
00.00P, 00.00i	Frame rate (☐ 62) • During slow & fast motion recording, the shooting frame rate is also displayed (000/00.00P).	2: [Frame Rate]
REC➔, STBY➔	Output recording command (☐ 185)	2: [Rec Command]
Gen	Genlock (☐ 93)	2: [Genlock]
00:00:00.00, 00:00:00:00	Time code (☐ 88)	2: [Time Code]



Right side of the screen

Icon/Display	Description	Custom Display
SD 0000	Approximate number of photos that can be recorded on the SD card (☐ 175)	2: [Remaining Photos]
YCC422 10 bit, RGB444 10 bit, RGB444 12 bit	Color sampling (☐ 62)	2: [Resolution/ Color Sampling]
0000x0000	Resolution (☐ 62)	2: [Resolution/ Color Sampling]
Rec C_{OFF} , MON OFF , HD OFF	Output terminals not active (☐ 163)	2: [Output Terminals Status]
DISP➔ (in red)	Output onscreen displays (☐ 168)	2: [OSD Output]
📶	GPS signal (☐ 108): continuously on - satellite signal acquired; flashing - satellite signal not acquired. • Displayed only when an optional GP-E1 GPS Receiver is connected to the camera.	2: [GPS]
MEMO	User memo (☐ 106)	2: [User Memo]
00 00 00 00	User bit (☐ 91)	2: [User Bit]
CHO/CHO	Audio output channels (☐ 169)	2: [Monitor Channels]
Date/time		2: [Date/Time]

Bottom/Bottom-Center of the screen

Icon/Display	Description	Custom Display
	Key lock (📖 55)	1: [Key Lock]
A001C001 to Z999D999	Clip identification. Includes the camera index, reel number and clip number components of the clip file name (📖 59).	2: [Reel/Clip Number]
 0000 K,  A/  B 0000 K,  K 0000 K,  , 	White balance (📖 74)	1: [White Balance]
	Headphone volume (📖 151)	–
	A viewing LUT has been applied to at least one display or output terminal (📖 167) <ul style="list-style-type: none"> The icon will appear on all active display devices regardless of which screen/output terminal the LUT was applied to. 	1: [LUT]
	Magnification (📖 79)	1: [Magnification]
 , 	Peaking (📖 79)	1: [Peaking]
ND 00 stops	ND filter (📖 69)	1: [ND Filter]
 , F0.0, T0.0	Aperture value (📖 70)	1: [Iris]
AE ±0.00	AE Shift (📖 72)	1: [Exposure]
	Exposure bar (📖 73) <ul style="list-style-type: none"> Only displayed when the gain, iris and shutter are all set to manual adjustment. 	1: [Exposure]
ISO 000000, 00.0dB	ISO speed/Gain (📖 67)	1: [ISO/Gain]
1/0000, 000.00Hz, 000.00°	Shutter speed (📖 65)	1: [Shutter]
	Audio peak limiter (📖 99)	2: [Audio Level]
	Audio level meter (📖 99, 100)	

 NOTES

- You can repeatedly press the DISP. button on the monitor unit or an assignable button set to [Display] (📖 131) to switch the onscreen displays in the following sequence. You can also customize the sequence, turning individual display levels on/off with the [ Picture/Terminals Setup] ➤ [DISP. Button Levels] submenu.
 - Show all onscreen displays → surrounding icons¹ → show onscreen markers² → hide all onscreen displays³.
- ¹ The image is somewhat reduced and smaller icons are displayed around the periphery of the image. At this display level, the following onscreen displays will not appear: focal length, resolution and color sampling, user bit, AE shift, exposure bar and audio output channels.
- ² Only when [ Assistance Functions] ➤ [Markers] ➤ [Activate] is set to [On]. The various frames used for focus-related functions are displayed as well.
- ³ Except for the recording operation.

Rear Panel Displays

You can check the following information on the rear panel. This allows you to easily adjust main camera functions like the shutter speed, white balance and ISO speed/gain even when the monitor unit is not attached to the camera without having to use the viewfinder.

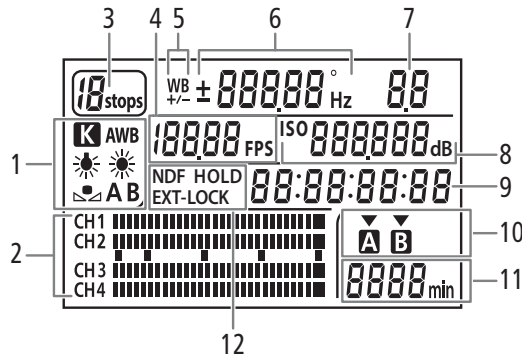

- | | |
|--|---|
| 1 White balance (74) | 7 Aperture value (70) |
| 2 Audio level meter ¹ (99, 100) | 8 ^{ISO} 250 ISO speed/ 60 ^{dB} Gain (67) |
| 3 ND filter (69) | 9 Time code ¹ (88) |
| 4 Frame rate (62) | 10 CFast card selected for recording/playback ¹ |
| 5 White balance fine-tuning (75) | 11 Estimated remaining recording time |
| 6 Shutter speed (65)/White balance (74) | 12 Time code settings |
| 100 Shutter speed ² (mode set to [Speed], [Slow] or [Off]) | NDF Non-drop frame (89) / |
| 18000' Shutter speed (mode set to [Angle]) | HOLD Time code display on hold (89) / |
| 5994 Hz Shutter speed (mode set to [Clear Scan]) | EXT-LOCK External time code signal locked (93) |
| ±0 White balance fine-tuning ³ (75) | |
| 5500 White balance, color temperature ³ (75) | |

¹ Displayed also in [MEDIA] mode.

² In these shutter speed modes, only the denominator is displayed - **100** indicates a shutter speed of 1/100, etc.

³ Only displayed while adjusting the setting.

Using the illumination button

The camera features an illumination button that turns on/off the illumination of the rear panel and some of the buttons on the camera's body. This can be convenient when using the camera in dark surroundings.

- You can set the brightness of the rear panel to one of five levels with the [Picture/Terminals Setup] ➤ [Panel Luminance] setting.

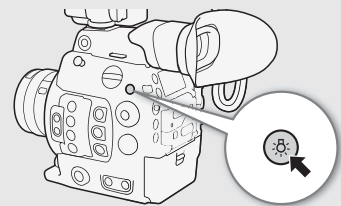

Setting the Clip File Name

The camera allows you to change several settings that determine the file name of the recorded clips. Personalize the clip file name according to your preferences or organizational conventions to create files that are easier to identify and organize.

Operating modes: CAMERA MEDIA

The basic file name structure is as follows. When a primary clip and proxy clip are recorded simultaneously, the clips' file names will be identical for the most part (components 1 to 6).

A 0 0 1 C 0 0 1 _ y y m m d d X X _ C A N O N _ 0 1 P

1 2 3 4 5 6 7

- 1 **Camera index:** One character (A to Z) that identifies the camera used.
- 2 **Reel number:** 3 characters (001 to 999) that identify the recording media used.
- 3 **Clip number:** 4 characters (C001 to D999). The clip number advances automatically with each clip recorded (switching to D001 after C999), but you can set the initial clip number.
- 4 Recording date (set automatically by the camera).
- 5 Random component: 2 characters (numbers 0 to 9 and capital letters A to Z) that change randomly with each clip.
- 6 **User defined field:** 5 characters (numbers 0 to 9 and capital letters A to Z) for any other identification purposes.
- 7 The camera will automatically add the suffix “_P” to the file name of proxy clips. Additionally, when an SD or SDHC card is used to record proxy clips, a stream number (01 to 99) will be added before the “P”. The stream number will advance every time the video (stream) file within the clip is split and recording continues on a separate stream file.

Setting the components of the clip file name

To set the camera ID

- 1 Open the [Camera Index] screen.
[Camera Icon] Recording/Media Setup] ➤ [Metadata] ➤ [Camera Index]
- 2 Push the joystick up/down or turn the SELECT dial to select the desired camera ID and then press SET twice.

To set the reel number or initial clip number

- 1 Open the [Reel Number] or [Clip Number] screen.
[Camera Icon] Recording/Media Setup] ➤ [Metadata] ➤ [Reel Number] or [Clip Number]
- 2 Select [Set] and then press SET.
 - To reset the reel/clip number to [001], select [Reset] instead.
- 3 Push the joystick up/down or turn the SELECT dial to select the first digit of the reel/clip number and then press SET to move to the next.
 - Change the rest of the digits in the same way.
- 4 Select [Set] and then press SET.
- 5 If you changed the reel number, initialize all the recording media being used for recording (CFast and SD cards, see page 49).

To set the user-defined field

- 1 Open the [User Defined] screen.
[Camera Icon] Recording/Media Setup] ➤ [Metadata] ➤ [User Defined]
- 2 Push the joystick up/down or turn the SELECT dial to select the first character and then press SET to move to the next.
 - Change the rest of the characters in the same way.
- 3 Select [Set] and then press SET.

[Camera Icon] Recording/Media Setup]

[Metadata]

[Camera Index] [A]
[Reel Number] [001]
[Clip Number] [001]
[User Defined] [CANON]

Using the Fan

The camera uses an internal cooling fan to reduce the camera's internal heat. In **CAMERA** mode, you can change the fan's operation mode and speed. In **MEDIA** mode, the fan runs at all times but you can select its speed.

Setting the Fan's Operation in **CAMERA** Mode

In addition to the fan's operation mode, you can select independently the fan speed used while recording and in record standby mode.

Operating modes: **CAMERA** **MEDIA**

- 1 Open the fan's [Mode] submenu.
[System Setup] ➤ [Fan] ➤ [Mode]
- 2 Select the desired option and then press SET.

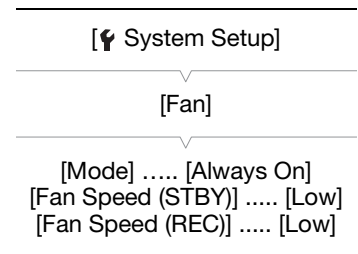

If you selected **[Automatic]**:

- 3 To set the fan speed to be used while recording, select [Fan Speed (REC)] and then press SET.
- 4 Select the desired fan speed and then press SET.
 - Repeat steps 3 and 4, selecting [Fan Speed (STBY)] to set the fan speed in record standby mode.
 - The [Maximum] option offers the maximum cooling effect but is available only for [Fan Speed (STBY)], as it is noisier.

If you selected **[Always On]**:

- 3 Select [Fan Speed (Always)] and then press SET.
- 4 Select the desired fan speed and then press SET.

Options

[Automatic]: The fan runs while the camera is not recording and is automatically turned off while the camera is recording. However, if the internal temperature of the camera is too high (appears in red), the fan will be activated automatically (in that case, **FAM** will appear next to the icon). When the camera's temperature has decreased sufficiently, the fan will be turned off. Use this setting when you do not want the camera to pick up the fan's operating sound.

[Always On]: The fan runs at all times.

Setting the Fan Speed in **MEDIA** Mode

Operating modes: **CAMERA** **MEDIA**

- 1 Open the [Fan Speed] submenu.
[System Setup] ➤ [Fan Speed]
- 2 Select the desired fan speed and then press SET.

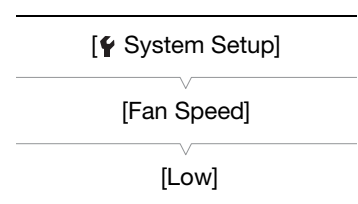

IMPORTANT

- While the fan is running, the exhaust vent will emit warm air.
- Be careful not to obstruct in any way the fan's air vents (14, 15).

NOTES

- Depending on the ambient temperature and other shooting conditions, the fan may not turn off even if you set its operating mode to [Automatic].

Video Configuration: System Frequency, Frame Rate, Resolution and Bit Rate

Before you record, set the video configuration used for primary clips by selecting the resolution (frame size) and color sampling settings, bit rate and frame rate that best match your creative needs. Available frame rate options will depend on the system frequency selected. See the table following the procedures for a summary.

For details about the video configuration of proxy clips, refer to *Simultaneous Recording of Proxy Clips* (📖 111).

Selecting the System Frequency

Operating modes:

1 Open the [System Frequency] submenu.

[📷 Recording/Media Setup] ➤ [System Frequency]

2 Select the desired option and then press SET.

- The camera will reset and restart in the selected mode.

[📷 Recording/Media Setup]

[System Frequency]

[59.94 Hz] or [50.00 Hz]*

* Depending on the country/region of purchase.

Selecting the Frame Rate

This procedure is not necessary when the system frequency is set to [24.00 Hz].

Operating modes:

1 Open the [Frame Rate] submenu.

[📷 Recording/Media Setup] ➤ [Frame Rate]

2 Select the desired option and then press SET.

- The selected frame rate will appear on the top of the screen and will be displayed also on the rear panel.

[📷 Recording/Media Setup]

[Frame Rate]

[29.97P] or [25.00P]*

* Depending on the country/region of purchase.

Selecting the Resolution and Color Sampling Settings

Operating modes:

1 Open the [Resolution/Color Sampling] submenu.

[📷 Recording/Media Setup] ➤ [Resolution/Color Sampling]

2 Select the desired option and then press SET.

- By default, the resolution/color sampling used does not appear on the screen but you can choose to display it with the custom display function (📖 57).

[📷 Recording/Media Setup]

[Resolution/Color Sampling]

[3840x2160 YCC422 10 bit]

Selecting the Bit Rate

The bit rate can only be changed when the resolution is set to [2048x1080 YCC422 10 bit] or [1920x1080 YCC422 10 bit].

Operating modes: CAMERA MEDIA

1 Open the [Bit Rate] submenu.

[Recording/Media Setup] ➔ [Bit Rate]

2 Select the desired option and then press SET.

- By default, the bit rate used does not appear on the screen but you can check it on the [Video 2/3] status screen (📖 196).

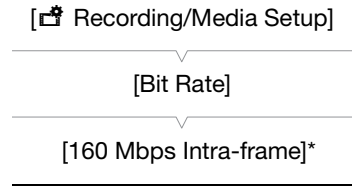

* At 29.97P, 25.00P or 24.00P. The default bit rate changes depending on the frame rate used.

Available video configuration settings

Resolution and color sampling		Bit rate and compression ¹	System frequency/Frame rate			
			59.94 Hz			
			59.94P	59.94i ²	29.97P	23.98P
4096x2160 3840x2160	YCbCr 4:2:2, 10 bit	410 Mbps, Intra-frame	–	–	●	●
		225 Mbps, Intra-frame	–	–	●	●
2048x1080 1920x1080	RGB 4:4:4, 10 bit	210 Mbps, Intra-frame	–	–	●	●
		310 Mbps, Intra-frame	●	–	–	–
	YCbCr 4:2:2, 10 bit	160 Mbps, Intra-frame	–	●	●	●
		50 Mbps, Long GOP	●	●	●	●

Resolution and color sampling		Bit rate and compression ¹	System frequency/Frame rate			
			50.00 Hz			24.00 Hz
			50.00P	50.00i ²	25.00P	24.00P
4096x2160 3840x2160	YCbCr 4:2:2, 10 bit	410 Mbps, Intra-frame	–	–	●	●
		225 Mbps, Intra-frame	–	–	●	●
2048x1080 1920x1080	RGB 4:4:4, 10 bit	210 Mbps, Intra-frame	–	–	●	●
		310 Mbps, Intra-frame	●	–	–	–
	YCbCr 4:2:2, 10 bit	160 Mbps, Intra-frame	–	●	●	●
		50 Mbps, Long GOP	●	●	●	●

¹ The camera uses a variable bit rate (VBR). Intra-frame options compress the image after analyzing each frame separately and are more appropriate for editing. Long GOP options compress the image after analyzing also changes across a group of pictures and offer better compression (smaller data size).

² Only when the resolution is set to HD (1920x1080).

NOTES

- A single CFast card cannot be used to record clips using different system frequencies.
- For details on the signal output from each terminal, refer to *Video Output Configuration* (📖 161).
- When the REC OUT terminal's output is set to 4K RAW output, frame rates exceeding 29.97P cannot be selected.

Changing Main Camera Functions with the FUNC. Button

You can adjust three main camera functions –shutter speed, white balance and ISO speed/gain– using the FUNC. button (direct setting mode). In direct setting mode, you can change settings using the LCD screen/viewfinder or using only the rear panel, which is convenient when the monitor unit is not attached to the camera. This section will explain the basic operation of the direct setting mode. For specific details about the functions refer to the each function's section: shutter speed (☞ 65), white balance (☞ 74), ISO speed/gain (☞ 67).

Operating modes: CAMERA MEDIA

Using the Direct Setting Mode

1 Press the FUNC. button.

- **On the screen:** The onscreen display of the function to be adjusted will be highlighted in orange.
- **On the rear panel:** Only the icon (white balance) or value (ISO speed, gain, shutter speed) of the function to be adjusted will be displayed.
- Press the FUNC. button repeatedly or push the joystick left/right to select the function you wish to adjust.

2 Push the joystick up/down or turn the SELECT dial to select the desired value (ISO speed, gain, shutter speed) or desired white balance mode and then press SET.

- The selected value will be set and the camera will exit the direct setting mode.
- **On the screen:** The onscreen display of the selected function will return to normal.
- **On the rear panel:** The display will return to normal (all displays will reappear).
- Depending on the function selected, additional adjustment may be possible or necessary before pressing SET.

NOTES

- The camera will automatically end the direct setting mode in the following cases.
 - If no operation was performed for more than 6 seconds.
 - If the menu or a status screen was opened.
 - If the aperture was adjusted or the ND filter setting was changed.
 - If the control dial's function is set to [ISO/Gain] and you operate the control dial.

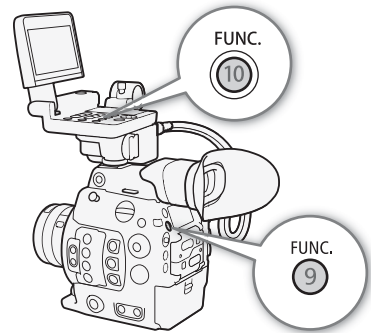

Shutter Speed

Set the shutter speed based on the recording conditions. For example, you may want to set slower shutter speeds in darker environments. The camera offers the following modes.

You can also perform this function remotely using Browser Remote on a connected Wi-Fi device (📖 120, 124).

Operating modes: CAMERA MEDIA

[Speed]: Allows you to set the shutter speed (in fractions of a second). You can select the increment to use when adjusting the shutter speed between 1/3-stop and 1/4-stop increments.

[Angle]: You can set the shutter angle to determine the shutter speed.

[Clear Scan]: Set the frequency in order to record CRT computer monitors without displaying black bands or flicker on the screen.

[Slow]: You can set slower shutter speeds to obtain brighter recordings in places with insufficient lighting. This mode is not available during slow & fast motion recording.

[Off]: The camera uses a standard shutter speed based on the frame rate.

Available Shutter Speeds

The available shutter speeds vary depending on the system frequency and frame rate used.

Shutter speed mode		System frequency/Frame rate					
		59.94 Hz		24.00 Hz	50.00 Hz		
		59.94P / 59.94i	29.97P	23.98P	24.00P	50.00P/ 50.00i	25.00P
[Speed] ¹	1/3-stop increments	1/1, 1/1.26, 1/1.59, 1/2 to 1/2000					
	1/4-stop increments	1/1, 1/1.19, 1/1.41, 1/1.68, 1/2 to 1/24, 1/30, 1/34, 1/40, 1/48, 1/60 to 1/2000			1/1, 1/1.19, 1/1.41, 1/1.68, 1/2 to 1/25, 1/30, 1/33, 1/40, 1/50, 1/60 to 1/2000		
[Angle] ^{1, 2}		360.00°, 240.00°, 180.00°, 120.00°, 90.00°, 60.00°, 45.00°, 30.00°, 22.50°, 15.00°, 11.25°					
[Clear Scan] ¹		23.98 Hz to 250.38 Hz			24.00 Hz to 250.40 Hz		
[Slow] ³		1/4, 1/8, 1/15, 1/30	1/4, 1/8, 1/15	1/3, 1/6, 1/12		1/3, 1/6, 1/12, 1/25	1/3, 1/6, 1/12
[Off] ¹		1/60	1/30	1/24	1/24	1/50	1/25

¹ During slow & fast motion recording, available values will vary depending on the selected shooting frame rate.

² You can also select angle values equivalent to the following shutter speeds: 1/100, 1/60, 1/50, 1/40, 3/100, 1/30, 1/25. Available angle values will vary depending on the frame rate used.

³ Not available during slow & fast motion recording.

Changing the Shutter Speed Mode and Value

You can also perform this function remotely using Browser Remote on a connected Wi-Fi device (📖 120, 124).

1 Open the shutter speed [Mode] submenu.

[Camera Setup] ➤ [Shutter] ➤ [Mode]

2 Select the desired mode and then press SET.

- If you selected [Speed] (the default value), continue the procedure to select the increment scale to use when adjusting the shutter speed; otherwise, skip to step 5.

3 Open the [Shutter Increment] submenu.

[Camera Setup] ➤ [Shutter] ➤ [Shutter Increment]

4 Select [1/3 stop] or [1/4 stop] and then press SET.

5 Adjust the shutter speed, angle value or clear scan frequency using the direct setting mode.

- After closing the menu, press the SHUTTER button to enter the direct setting mode with the shutter speed highlighted. Select the desired value and then press SET. For details refer to *Using the Direct Setting Mode* (📖 64).
- You can also use the FUNC. button and joystick to enter the direct setting mode.
- The selected shutter speed will appear on the bottom of the screen and will be displayed also on the rear panel.

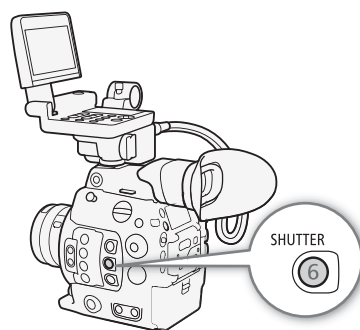
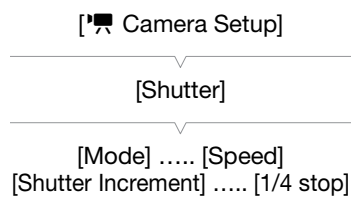

Using Slow Shutter Mode

When recording in dark surroundings, you can obtain a brighter picture by using slow shutter mode. You can also use this mode when you wish to add certain effects to your recordings, such as blurring the background during panning shots or recording a moving subject with an afterimage trail.

- Image quality may not be as good as when using faster shutter speeds in brighter surroundings.

NOTES

- When recording under artificial light sources such as fluorescent, mercury or halogen lamps, the screen may flicker depending on the shutter speed. You may be able to avoid flicker by setting the shutter speed mode to [Speed] and the shutter speed to a value matching the frequency of the local electrical system: 1/50* or 1/100 for 50 Hz systems, 1/60 or 1/120 for 60 Hz systems.
- Closing down the aperture when recording under bright conditions may cause the picture to appear soft or out of focus. To avoid the loss of sharpness due to diffraction, use a faster shutter speed, a denser ND filter (📖 69) or open up the aperture.
- When the shutter speed mode is set to [Slow], bright red, green or blue dots may appear on the screen. In such case, use a faster shutter speed or select a lower ISO speed or gain value (📖 67).
- When an optional RC-V100 Remote Controller is connected to the camera, you can change the shutter speed mode with the remote controller's SHUTTER SELECT button and the shutter speed value with the remote controller's SHUTTER ▲/▼ buttons.
- Even when [Custom Picture] ➤ [Main Settings] ➤ [Gamma] or [Color Matrix] is set to [EOS Standard], if you set the camera to a certain shutter speed, you may not get exactly the same image brightness as you would on an EOS digital SLR camera set to the same shutter speed.

* May not be available depending on the frame rate.

ISO Speed/Gain

Depending on the shooting conditions, you may want to adjust the brightness of the image. You can do so by changing the ISO speed or gain value to adjust the sensitivity of the sensor. You can also perform this function remotely using Browser Remote on a connected Wi-Fi device (📖 120, 124).

Operating modes: CAMERA MEDIA

Available ISO speed and gain settings¹

	Increment ²	Normal range	Extended range ³
ISO speed	[1 stop] (1-stop increments)	160, 200, 400, 800, 1600, 3200, 6400, 12800, 25600	100, 51200, 102400
	[1/3 stop] (1/3-stop increments)	160 ⁴ , 200, 250, 320, 400, 500, 640, 800, 1000, 1250, 1600, 2000, 2500, 3200, 4000, 5000, 6400, 8000, 10000, 12800, 16000, 20000, 25600	100, 125, 32000, 40000, 51200, 64000, 80000, 102400
Gain	[Normal] (3-dB increments)	-2 dB ⁴ , 0 dB to 42 dB	-6 dB, -3 dB, 45 dB to 54 dB
	[Fine] (0.5-dB increments)	-2 dB to 24 dB	-

¹ The minimum sensitivity needed to obtain the recommended dynamic range is ISO 400 / 6 dB gain (when [📷 Custom Picture] ➤ [Main Settings] ➤ [Gamma] is set to [Canon Log] or [Wide DR]) or ISO 800 / 12 dB gain (when it is set to [Canon Log 2]).

² [📷 Camera Setup] ➤ [ISO/Gain] ➤ [ISO Increment] setting (ISO speed), or [📷 Camera Setup] ➤ [ISO/Gain] ➤ [Gain Increment] setting (gain).

³ Sensitivity settings that are not recommended but can still be used by setting [📷 Camera Setup] ➤ [ISO/Gain] ➤ [Extended Range] to [On].

⁴ Available only when [📷 Camera Setup] ➤ [ISO/Gain] ➤ [Extended Range] is set to [Off].

Changing the ISO Speed or Gain Value

- Open the ISO speed/gain [Select] submenu.
[📷 Camera Setup] ➤ [ISO/Gain] ➤ [Select]
- Select [ISO] or [Gain] and then press SET.
- Open the [ISO Increment] or [Gain Increment] submenu to select the adjustment increment to use when adjusting the ISO speed or gain, respectively.
[📷 Camera Setup] ➤ [ISO/Gain] ➤ [ISO Increment] (ISO speed)
[📷 Camera Setup] ➤ [ISO/Gain] ➤ [Gain Increment] (gain)
- Select the desired option and then press SET.
- After closing the menu, press the ISO/GAIN button to enter the direct setting mode with the ISO speed or gain value highlighted.
 - Select the desired value and then press SET. For details refer to *Using the Direct Setting Mode* (📖 64).
 - You can also use the FUNC. button and joystick to enter the direct setting mode.
 - The selected ISO speed/gain value will appear on the bottom of the screen and will be displayed also on the rear panel.

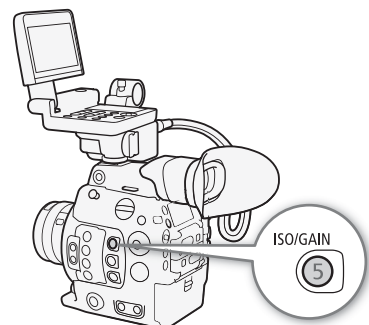
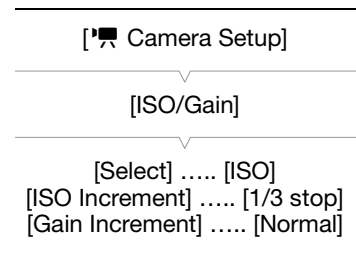

Using the Control Dial

You can adjust the ISO speed or gain value using the control dial on the camera or that on the grip unit.

You will need to set in advance the function of one of the control dials to [ISO/Gain]. You can select the function assigned to each control dial independently.

Assigning ISO Speed/Gain Control to a Control Dial

1 Open the [Camera Control Dial] (control dial on the camera) or [Grip Control Dial] (control dial on the grip unit) submenu.

[ System Setup]  [Custom Function]  [Camera Control Dial] or [Grip Control Dial]

2 Select [ISO/Gain] and then press SET.

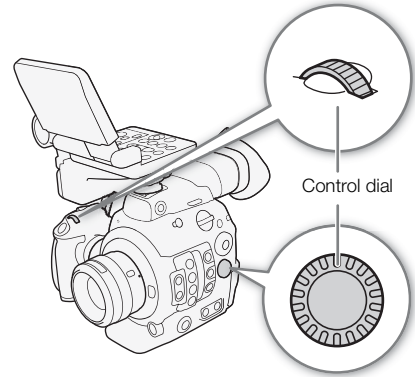





[ System Setup]

[Custom Function]

[Camera Control Dial]
[Grip Control Dial]

[Iris]

NOTES

- When high ISO speeds or gain levels are set, the picture may flicker slightly.
- When high ISO speeds or gain levels are set, bright red, green or blue dots may appear on the screen. In such case, use a faster shutter speed ([65](#)) or select a lower ISO speed or gain value.
- When the ISO speed or gain level is changed, some noise may appear momentarily on the screen. Do not adjust the ISO speed/gain level while recording.
- You can use the [ System Setup]  [Custom Function]  [Camera Control Dial Dir.] or [Grip Control Dial Dir.] setting ([144](#)) to change the direction of the adjustment when you turn the control dial on the camera or on the grip unit, respectively.
- When an optional RC-V100 Remote Controller is connected to the camera, you can adjust the ISO speed or gain value with the remote controller's ISO/GAIN / buttons.

ND Filter

Using the ND filter allows you to open up the aperture to obtain a shallower depth of field even when recording in bright surroundings. You can also use the ND filter to avoid the soft focus caused by diffraction when using small apertures. By default, you can select one of 3 density levels (2 to 6 stops) and, if you enable the extended ND range, you can select one of 5 density levels (2 to 10 stops).

You can also perform this function remotely using Browser Remote on a connected Wi-Fi device (📖 120, 124).

Operating modes: CAMERA MEDIA

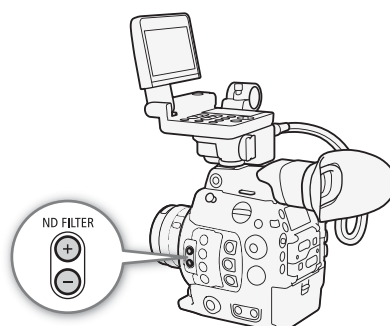

Press the ND FILTER + or – button to select the desired ND filter setting.

- Repeatedly pressing ND FILTER + button will change the ND filter setting in the following order: [ND 2 stops] → [ND 4 stops] → [ND 6 stops] → [ND 8 stops]* → [ND 10 stops]* → ND filter off. (The ND FILTER – button cycles through the settings in reverse order.)
- The selected ND filter setting will appear on the bottom of the screen and will be displayed also on the rear panel.

* Only when [📷 Camera Setup] ➤ [Extended ND Range] is set to [On].

i NOTES

- If you set an assignable button to [ND +] or [ND –] (📖 131), you can press the button to change the ND filter setting.
- Depending on the scene, the color may change when turning the ND filter on/off. Setting a custom white balance (📖 74) may be effective in such case.
- **About the extended ND range:** When you switch to or from a density level in the extended range (8 or 10 stops), you may notice one or both of the following circumstances.
 - The focus may shift, affecting also the indication on the lens's focus distance scale.
 - Depending on the lens, the camera may not be able to focus at infinity focus.
- **About changing the ND filter setting using the optional RC-V100 Remote Controller:**
 - When the remote controller is connected to the camera, you can use the remote controller's ND button in the same way as the camera's ND FILTER + button.
 - For settings between 2 and 8 stops, the corresponding ND filter indicator (1 to 4, respectively) will illuminate in orange. When the ND filter is set to 10 stops, indicators 1 and 4 will both illuminate.

Adjusting the Aperture

You can affect the brightness of your recordings or change the depth of field by adjusting the aperture. The camera offers 3 ways to adjust the aperture but available aperture values will vary depending on the lens attached. By default, the camera is set to manual aperture.

Manual aperture: Adjust the aperture value manually using the control dial on the camera or on the grip unit, or remotely, using Browser Remote on a connected Wi-Fi device (📖 120, 124).

Push Auto Iris*: Momentary automatic aperture. During manual aperture, press an assignable button or use Browser Remote (📖 120, 124) to temporarily adjust the aperture automatically.

Automatic aperture:** The camera adjusts the aperture automatically.

* Not available when a Canon Cinema lens is attached to the camera.

**Available only with compatible EF lenses (📖 213).

Operating modes: CAMERA MEDIA

Manual Aperture

You can adjust the aperture value of an EF lens using the control dial on the camera or the grip unit. You can select the function assigned to each control dial independently.

By default, both control dials' function is set to aperture control. If it has been changed, follow the procedure below to set in advance the function of one of the control dials to [Iris].

Assigning aperture control to a control dial

- 1 Open the [Camera Control Dial] (control dial on the camera) or [Grip Control Dial] (control dial on the grip unit) submenu.
[🔧 System Setup] ➡ [Custom Function] ➡ [Camera Control Dial] or [Grip Control Dial]
- 2 Select [Iris] and then press SET.

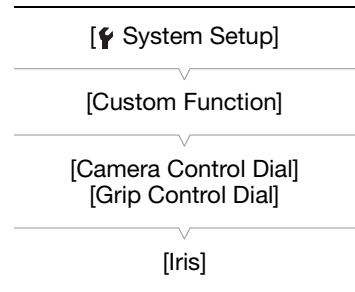

Changing the aperture mode and value

- Open the aperture [Mode] submenu.
 - [Camera Setup] ➤ [Iris] ➤ [Mode]
 - This setting is available only when an EF lens compatible with automatic aperture is attached to the camera.
 - For non-compatible lenses, the aperture mode will be set to [Manual] and cannot be changed. Skip to step 3.
- Select [Manual] and then press SET.
- Open the [Iris Increment] submenu.
 - [Camera Setup] ➤ [Iris] ➤ [Iris Increment]
- Select [1/2 stop], [1/3 stop] or [Fine] and then press SET.
- Turn the control dial assigned to [Iris] to adjust the aperture.
 - The selected aperture value will appear on the bottom of the screen and will be displayed also on the rear panel.
 - When [Iris Increment] is set to [Fine], the actual increments will be smaller than 1/3 stop but the display will show the closest 1/3-stop aperture value.

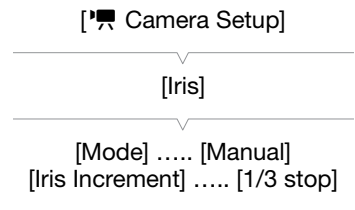
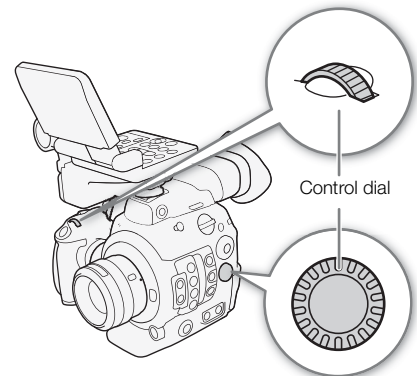

NOTES

- You can use the [System Setup] ➤ [Custom Function] ➤ [Camera Control Dial Dir.] or [Grip Control Dial Dir.] setting ([book 144](#)) to change the direction of the adjustment when you turn the control dial on the camera or on the grip unit, respectively.
- If you set an assignable button to [Iris +] or [Iris -] ([book 131](#)), you can press the button to respectively open up the aperture (smaller F values) or close it (larger F values).
- When using an EF lens with no lens contacts or an EF Cinema lens (except for a CINE-SERVO CN7x17 KAS S/E1 lens), you cannot adjust the aperture using the camera. Adjust the aperture using the lens.
- When using an EF lens that can correct the aperture value according to the position of the zoom, you can use the [Camera Setup] ➤ [Iris] ➤ [Zoom-Iris Correct.] setting to activate this correction.
- When an optional RC-V100 Remote Controller is connected to the camera, you can adjust the aperture with the remote controller's IRIS dial. At default settings, turn the dial right to open up the aperture and left to close the aperture.
- When using a Canon Cinema lens, you can change the displays to T values instead of F values with the [Camera Setup] ➤ [Iris] ➤ [Iris Indicator] setting.
- The aperture value (F value or T value) displayed on the screen may differ from the indication on the lens's aperture scale.

Momentary Automatic Aperture - Push Auto Iris

During manual aperture, you can press the PUSH AUTO IRIS button to have the camera temporarily take control and automatically adjust the aperture for an optimal exposure.

You can also perform this function remotely using Browser Remote on a connected Wi-Fi device ([book 120, 124](#)).

- Set [Camera Setup] ➤ [Iris] ➤ [Mode] to [Manual] ([book 71](#)).
- Press and hold the PUSH AUTO IRIS button.
 - The camera will automatically adjust the aperture to obtain optimal exposure. As long as you hold the button pressed down, will appear on the screen next to the aperture value.

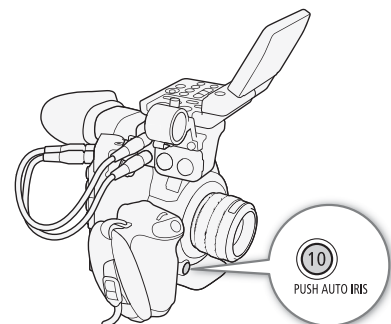

- When you release the button, automatic aperture mode will end and the **A** icon will disappear. The selected aperture value will appear on the bottom of the screen and will be displayed also on the rear panel.

i NOTES

- You can use the [Camera Setup] ➤ [AE] ➤ [AE Response] setting to change how quickly the aperture changes during automatic aperture mode.
- Push auto iris is not available during slow & fast motion recording.

Automatic Aperture

When a compatible EF lens is attached to the camera, you can have the camera automatically adjust the aperture.

1 Open the aperture [Mode] submenu.

[Camera Setup] ➤ [Iris] ➤ [Mode]

2 Select [Automatic] and then press SET.

- The camera will automatically adjust the aperture to obtain optimal exposure. The selected aperture value will appear on the bottom of the screen with an **A** icon next to it, and will be displayed also on the rear panel (📖 59).

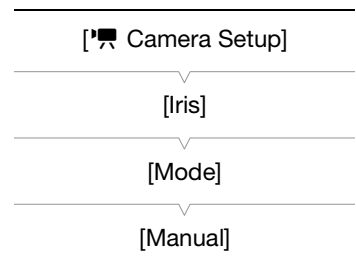

i NOTES

- If you set an assignable button to [Iris Mode] (📖 131), you can press the button to toggle between the [Automatic] and [Manual] settings when a compatible EF lens (📖 213) is attached to the camera.
- Automatic aperture is not available during slow & fast motion recording.

Exposure Compensation - AE Shift

Use AE shift to compensate the exposure that was set using automatic aperture, in order to darken or lighten the image.

You can also perform this function remotely using Browser Remote on a connected Wi-Fi device (📖 120, 124).

1 Open the [AE Shift] submenu.

[Camera Setup] ➤ [AE] ➤ [AE Shift]

2 Select an AE shift level and then press SET.

- You can select one of 17 AE shift levels from -2.0 to +2.0.
- The selected AE shift level will be displayed above the exposure bar and the camera will attempt to adjust the exposure accordingly.

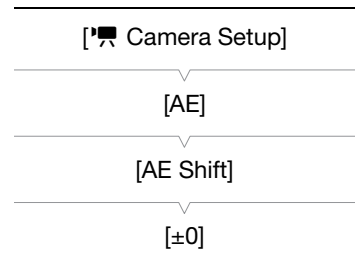

i NOTES

- If you set an assignable button to [AE Shift +] or [AE Shift -] (📖 131), you can press the button to adjust the AE shift level.
- You can also set the AE shift level by turning a control dial assigned to [Iris] while holding the PUSH AUTO IRIS button pressed down.

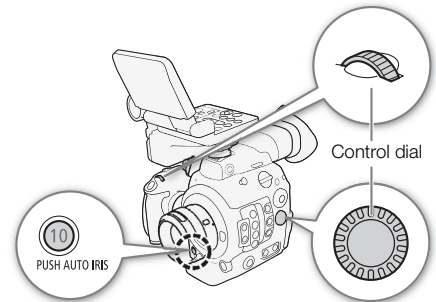

The Exposure Bar

The ▼ on top of the exposure bar indicates optimal exposure without any shift (AE±0); the scale markings indicate the deviation from optimal exposure in 1/2 EV increments. The indicator inside the exposure bar represents the current exposure. When the difference between current and optimal exposure is larger than ±2 EV, the indicator will flash at the edge of the exposure bar. Optimal exposure will change depending on the light metering mode used.

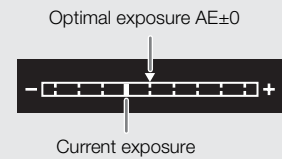

Light Metering Mode

Select the light metering mode to match the recording conditions. Using the appropriate setting will ensure that the camera obtains the most suitable exposure level when automatic aperture is used.

1 Open the [Light Metering] submenu.

[**☰** Camera Setup] ➤ [Light Metering]

2 Select the desired option and then press SET.

- The icon of the selected mode appears on the left of the screen.

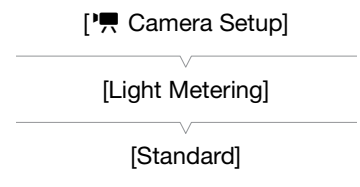

Options

[Backlight] **☒**: Suitable when recording backlit scenes.

[Standard]: Averages the light metered from the entire screen, giving more weight to the subject in the center.

[Spotlight] **▲**: Use this option when recording a scene in which only a certain part of the picture is lit, for example, when the subject is lit by a spotlight.

i NOTES

- If you set an assignable button to [Backlight] or [Spotlight] (📖 131), you can press the button to turn the respective light metering mode on and off.

White Balance

The camera uses an electronic white balance process to calibrate the picture and produce accurate colors under different lighting conditions. There are 4 methods of setting the white balance.

You can also perform this function remotely using Browser Remote on a connected Wi-Fi device (📖 120, 123).

Custom white balance: You can use a gray card or white object with no pattern to establish the white balance and set it to one of two custom white balance positions, 📷A or 📷B. When recording under fluorescent lights, we recommend setting the custom white balance.

Set color temperature: Allows you to set the color temperature between 2,000 K and 15,000 K.

Preset white balance: Set the white balance to ☀️ (daylight) or 💡 (incandescent lamp). Preset white balance settings can be further fine-tuned within a range of -9 to 9.

Auto white balance (AWB): The camera automatically adjusts the white balance to the optimal level.

Operating modes: CAMERA MEDIA

i NOTES

- The [📷 Custom Picture] ➡ [Other Settings] ➡ [Color Matrix Tuning] and [White Balance] settings in the custom picture file (📖 142) take precedence over the white balance set with these procedures.
- You can use the [📷 Camera Setup] ➡ [White Balance] ➡ [Shockless WB] setting to make the transition look smoother when you change the white balance settings.
- When an optional RC-V100 Remote Controller is connected to the camera, you can adjust the white balance with the remote controller's AWB button, A button, B button, PRESET button and 📷 button.
- The color temperatures displayed on the screen are approximate. Use them only as a reference.

Custom White Balance

1 Press the WB button.

- The white balance mode icon will be highlighted in orange.
- You can also use the FUNC. button and joystick to enter the direct setting mode.

2 Push the joystick up/down or turn the SELECT dial to select the 📷A or 📷B icon and then press SET.



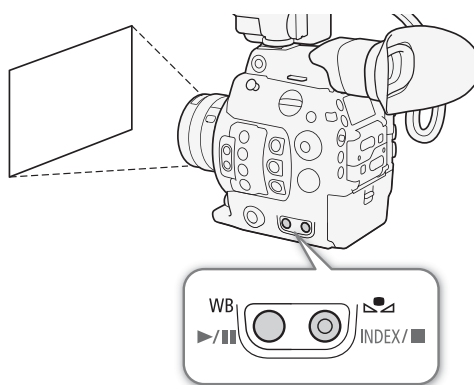

- If a custom white balance has been stored previously, pressing SET will apply the stored custom white balance. You do not need to perform the rest of the procedure.
- If a custom white balance has not yet been stored, the custom white balance icon 📷A or 📷B and default value (5,400 K) will flash slowly. Continue the procedure to establish the custom white balance.

3 Point the camera at a gray card or white object so that it fills the whole screen.

- Use the same lighting conditions you plan to use when recording.



4 Press the button.

- The  A or  B icon will flash quickly.
- Make sure the gray card or white object fills the screen until the procedure is completed.
- Once the icon stops flashing, the procedure is completed. The setting is retained even if you turn off the camera.
- The custom white balance setting will appear on the bottom left corner of the screen. On the rear panel, the  A or  B icon will be displayed but without the color temperature setting.

NOTES

- Readjust the custom white balance if the light source or ND filter setting changes.
- Very rarely and depending on the light source,  may keep flashing (it will change to a slow flashing). The result will still be better than with the auto white balance.

Color Temperature/Preset White Balance

1 Press the WB button.

- The white balance mode icon will be highlighted in orange.
- You can also use the FUNC. button and joystick to enter the direct setting mode.

2 Push the joystick up/down or turn the SELECT dial to select the icon (color temperature setting) or the or icon (preset white balance) and then press SET.

- Press SET to set the default color temperature or preset setting. To change the color temperature or fine-tune the preset white balance settings, continue the procedure instead of pressing SET.

3 Press the button.

- You can also press the FUNC. button or push the joystick right.
- **Color temperature:** On the screen, the default color temperature value (5,500 K) next to the white balance icon will be highlighted in orange. On the rear panel, only the  icon and 5,500 K will be displayed.
Preset white balance: On the screen, the adjustment value ± 0 will appear next to the white balance icon, highlighted in orange. On the rear panel, only the white balance icon and ± 0 will be displayed.

4 Push the joystick up/down or turn the SELECT dial to change the adjustment value or color temperature and then press SET.

- The selected adjustment value/color temperature will be set and will appear on the screen next to the white balance icon. On the rear panel, all displays will reappear and the white balance icon will be displayed but without the adjustment value or color temperature setting.

Auto White Balance (AWB)

The camera constantly adjusts the white balance automatically to achieve an optimal level. The camera will adjust the white balance if the light source changes.

1 Press the WB button.

- The white balance mode icon will be highlighted in orange.
- You can also use the FUNC. button and joystick to enter the direct setting mode.

2 Push the joystick up/down or turn the SELECT dial to select the **AWB** icon and then press SET.

- The white balance will be adjusted automatically and the color temperature set will appear on the screen next to the **AWB** icon. On the rear panel, all displays will reappear and the **AWB** icon will be displayed but without the color temperature setting.

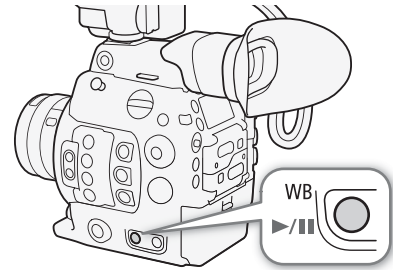

i NOTES

- Custom white balance may provide better results in the following cases:
 - Changing lighting conditions
 - Close-ups
 - Subjects in a single color (sky, sea or forest)
 - Under mercury lamps and certain types of fluorescent and LED lights
- You can use the [Camera Setup] ➤ [White Balance] ➤ [AWB Response] setting to change how quickly the white balance changes in auto white balance (AWB) mode.
- Auto white balance is not available during slow & fast motion recording.

Adjusting the Focus

The camera offers several ways to focus and incorporates Dual Pixel CMOS AF technology for advanced autofocus performance. You can also adjust the focus remotely using Browser Remote on a connected Wi-Fi device (📖 120, 125).

Manual focus: Turn the focus ring on the lens to adjust the focus. The camera offers several focus assistance functions (📖 78) to help you focus more accurately when using the manual focus.

One-shot AF*: With the lens's focus mode switch set to AF, you will be able to focus manually but still have the option to press the ONE-SHOT AF button to let the camera focus automatically once on the subject inside the AF frame.

AF-Boosted MF*: Focus manually most of the way and let the camera finish focusing automatically.

Continuous AF*: The camera continuously focuses on the subject inside the AF frame. You can use the focus lock function (📖 83) to change the composition of the picture while keeping the focus on the selected spot.

Face AF*: The camera automatically detects a person's face, focuses on it and can track it if that person moves.

* Not available when a manual focus lens is attached to the camera.

Focusing methods and required settings

Focusing method		Focus mode switch on the EF lens	AF mode ¹
Manual focus	Focus ring	MF or AF ²	[One Shot]
	Browser Remote	AF	
One-shot AF	ONE-SHOT AF button	AF	[One Shot]
	Browser Remote		
AF-Boosted MF	Focus ring → Camera (automatic)	AF	[AF-Boosted MF]
	Browser Remote → Camera (automatic)		
Continuous AF	Automatic (camera or Browser Remote)	AF	[Continuous]
Face AF ³	Camera or Browser Remote	AF	–

¹ [📷 Camera Setup] ➤ [Focus] ➤ [AF Mode].

² Depending on the lens, the focus ring may be disabled when the focus mode switch is set to AF.

³ You can activate this mode with the [📷 Camera Setup] ➤ [Focus] ➤ [Face Det. & Tracking] setting.

Operating modes: CAMERA MEDIA

Manual Focus

Focus manually using the focus ring on the lens. You can also perform this function remotely using Browser Remote on a connected Wi-Fi device (120, 125).

The autofocus mode is set to [One Shot] by default. If you need to change the setting, start the procedure from the beginning. Otherwise, you can start from step 3 below.

- 1 Open the focus [AF Mode] submenu.
[Camera Setup] ➤ [Focus] ➤ [AF Mode]
- 2 Select [One Shot] and then press SET.
- 3 Turn the focus ring to adjust the focus.

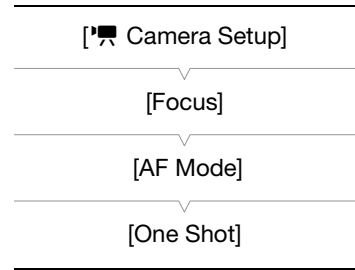

i NOTES

- With some EF lenses, you may be able to operate the focus ring even when the focus mode switch is set to AF.
- If you operate the zoom after focusing, the focus on the subject may be lost.
- If you focus manually and then leave the camera with the power turned on, the focus on the subject may be lost after a while. This possible slight shift in focus is a result of the internal temperature rising in the camera and lens. Check the focus before resuming shooting.
- When adjusting the focus, be careful not to touch the front of the lens or moving parts on the lens except for the focus ring.
- When an optional RC-V100 Remote Controller is connected to the camera, you can adjust the focus with the remote controller's FOCUS dial. At default settings, turn the dial right to focus farther and left to focus nearer.

Using the Focus Assistance Functions

In order to focus more accurately, you can use the following focus assistance functions: Dual Pixel Focus Guide, an onscreen guide that shows you if the picture is in focus; peaking, which creates a clearer contrast by emphasizing the outlines of the subject; and magnification, which enlarges the image on the screen. You can use peaking and the focus guide or peaking and magnification simultaneously for greater effect.

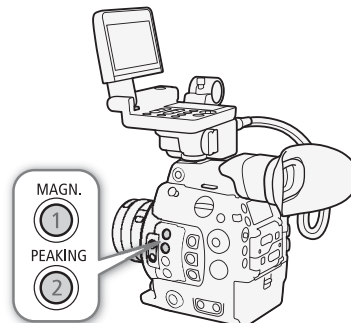
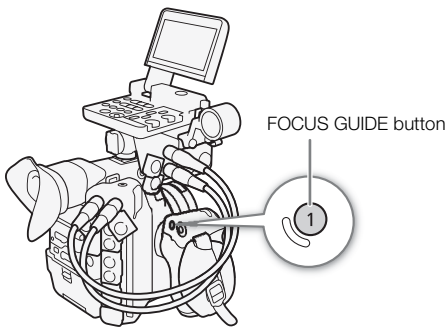

Dual Pixel Focus Guide

The focus guide gives you an intuitive visual indication of the current focus distance and the direction and amount of adjustment necessary to bring the picture into full focus. When used in combination with face detection and tracking (84), the guide will focus on the vicinity of the eyes of the person detected as the main subject.

Press the FOCUS GUIDE button to display the focus guide.

- Alternatively, you can use the [Assistance Functions] ► [Focus Guide] setting to turn the focus guide on and off.

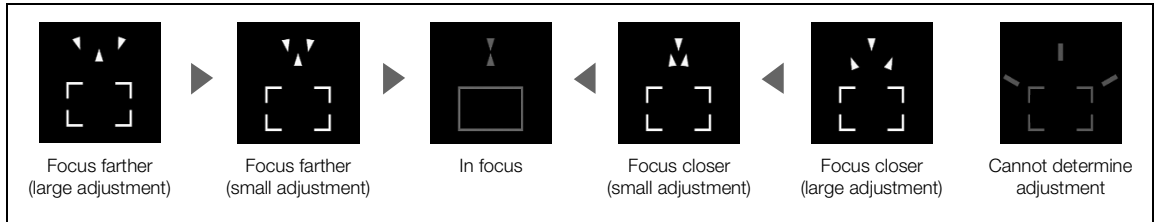

Peaking

The camera offers two peaking levels.

1 Press the PEAKING button.

- The peaking icon (**PEAK1** or **PEAK2**) appears at the lower center of the screen and the outlines in the image will be emphasized, depending on the focus.
- Press the button again to turn off peaking.
- Alternatively, you can use the [Assistance Functions] ► [Peaking] ► [Activate] setting to turn peaking on and off.

2 Open the peaking's [Select] submenu to select the peaking level.

[Assistance Functions] ► [Peaking] ► [Select]

3 Select the desired level and then press SET.

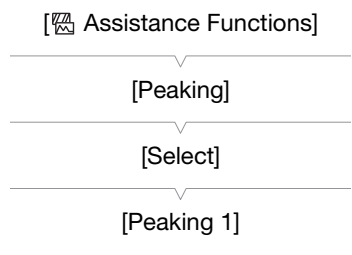

Magnification

1 Press the MAGN. button.

- MAGN.** appears at the lower center of the screen and the center of the screen* is magnified approximately 2 times.
 - The orange frame displayed on the top right of the screen (magnification frame) shows the approximate part of the image shown magnified.
- 2 If necessary, use the joystick or SELECT dial to move around the magnification frame and check other parts of the image.
- Press the CANCEL button to return the magnification frame to the center position.

3 Press the MAGN. button again to cancel the magnification.

* If one of the AF frames or a face detection frame is displayed on the screen, the area around the active frame will be magnified instead.

i NOTES

• **About Peaking/Magnification:**

- You can use the [Assistance Functions] ➤ [Peaking] ➤ [Peaking 1] and [Peaking 2] settings to set the color, gain and frequency of the two peaking levels independently of each other.
 - You can select individually whether to display the assistance functions on the LCD screen, the viewfinder or the MON. and HDMI OUT terminals with the display/output settings under [Assistance Functions] ➤ [Peaking] and [Assistance Functions] ➤ [Magnification].
 - You can also use the [Focus Assistance B&W] setting under [Assistance Functions] ➤ [Peaking] or [Magnification] to switch the screen to black & white while using the respective assistance function.
 - The assistance functions will not affect your recordings.
- The Dual Pixel Focus Guide function cannot be used in the following cases:
 - While the focus is being adjusted automatically using one-shot AF or continuous AF.
 - When the aperture value used is F11 or larger.
 - When a manual focus lens is attached to the camera.
 - When the Dual Pixel Focus Guide function and Face AF functions are used together, the focus guide may not focus the main subject's eyes correctly, depending on the direction in which the face is turned.

One-Shot AF

In this focus mode, you will focus manually in most situations but still have the option to have the camera focus automatically only once on the subject inside the AF frame that appears on the screen. You can also change the size and position of the AF frame.

1 Set the focus mode switch on the lens to AF.

- [AF] will appear on the left of the screen.

2 Open the focus [AF Mode] submenu.

- [Camera Setup] ➤ [Focus] ➤ [AF Mode]

3 Select [One Shot] and then press SET.

4 If necessary, change the size and position of the AF frame (83).

5 Press and hold the ONE-SHOT AF button.

- A white AF frame will appear on the screen and the camera will focus automatically. When you are using Face AF, the face detection frame around the face of the person who has been determined to be the main subject will turn white.
- When correct focus has been achieved, the AF frame turns green. If the camera cannot focus automatically, the AF frame will turn red.
- The AF frame will disappear when you release the ONE-SHOT AF button.

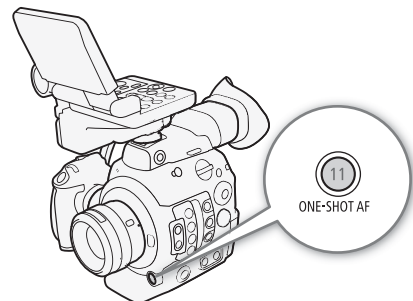
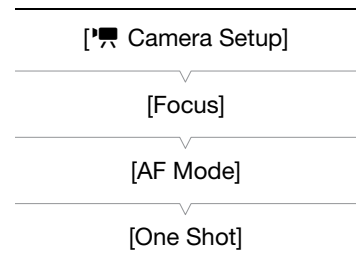

i NOTES

- One-shot AF is not available when the shutter speed mode is set to [Slow] and the shutter speed is set to 1/4 or 1/3.
- One-shot AF is not available when Face AF is set to [Face Only] and a face has not been detected.
- When the aperture value used is F11 or higher, Dual Pixel CMOS AF will not work and the camera will focus using contrast-detection autofocus.

AF-Boosted MF

In this focus mode, you can focus manually most of the way and let the camera finish focusing automatically. This is very convenient when you want to make certain that your 4K recordings are in sharp focus. Additionally, with this mode, if the camera cannot evaluate how to adjust the focus, it will not perform unreliable focus adjustments. This results in an overall smoother focusing operation than with continuous AF.

1 Set the focus mode switch on the lens to AF.

- [AF] will appear on the left of the screen.

2 Open the focus [AF Mode] submenu.

[Camera Setup] ➤ [Focus] ➤ [AF Mode]

3 Select [AF-Boosted MF] and then press SET.

- When the focus is in the manual adjustment range, a yellow focus frame will appear on the screen.

4 If necessary, change the size and position of the AF frame (83).

5 Turn the focus ring to adjust the focus.

- Focus manually to bring the subject closer into focus. When the focus enters the automatic adjustment range, the focus frame will turn white and the camera will then finish focusing automatically.
- While the focus stays within the automatic adjustment range, the camera will keep the subject in focus automatically.

[Camera Setup]

[Focus]

[AF Mode]

[One Shot]

Continuous AF

The camera will focus automatically on a subject inside the main area of the image (approximately 80% of the screen's length and width).

1 Set the focus mode switch on the lens to AF

- [AF] will appear on the left of the screen.

2 Open the focus [AF Mode] submenu.

[Camera Setup] ➤ [Focus] ➤ [AF Mode]

3 Select [Continuous] and then press SET.

- A white AF frame will appear on the screen. If necessary, change the size and position of the AF frame (83).
- When you are using Face AF, a white detection frame will appear around the face of the person who has been determined to be the main subject.

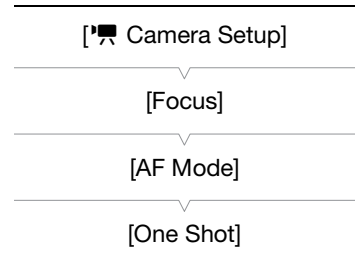

NOTES

• About the autofocus (AF) functions:

- Autofocus may not work well when the extended ISO/gain range is activated (67) and an ISO speed or gain value in the extended range is selected.
- Autofocus may not work well when [Custom Picture] ➤ [Main Settings] ➤ [Gamma] is set to [Canon Log], [Canon Log 2] or [Wide DR] (manually or through a preset custom picture setting).
- The point where the camera focuses may change slightly depending on shooting conditions, such as subject, brightness and zoom position. Check the focus before resuming shooting.
- Autofocus may take longer in the following cases.
 - When the frame rate set in the video configuration is set to 29.97P, 25.00P, 24.00P or 23.98P, or the shooting frame rate for slow & fast motion recording is set to 30, 25 or 24 (fps).
 - With some EF lenses, the camera may take longer to focus automatically or may not be able to focus correctly. Visit your local Canon Web site for the latest information.
- When using autofocus with compatible EF lenses, you can change various aspects of the autofocus function with the following settings. Visit your local Canon Web site for the latest information.
 - [Camera Setup] ➤ [Focus] ➤ [AF Speed] to set the AF speed (the speed at which the focus is adjusted) to one of 10 levels.
 - [Camera Setup] ➤ [Focus] ➤ [Apply AF Speed Limit] to select whether the selected AF speed is applied at all times or only while recording.
 - [Camera Setup] ➤ [Focus] ➤ [AF Response] to set the responsiveness of the autofocus function to one of 7 levels.
 - While using continuous AF, you can hold the ONE-SHOT AF button pressed down to temporarily adjust the focus using the maximum AF speed and AF response. This is helpful when you want to focus quickly after focus was lost or to keep a subject in focus while you follow it.
- Continuous AF will not work in the following cases.
 - When using an EF lens that does not have a focus mode switch.
 - While adjusting the aperture, except when using an EF lens compatible with automatic aperture (213).
 - While adjusting the focus using a remote controller attached to the REMOTE terminal.
- Autofocus may not work well on the following subjects or in the following cases. In such case, focus manually.
 - Reflective surfaces
 - Subjects with low contrast or without vertical lines
 - Fast moving subjects
 - Through dirty or wet windows
 - Night scenes
 - Subjects with a repetitive pattern

Activating AF Lock

While using continuous AF or AF-Boosted MF, you can lock the focus on a certain subject and then move the camera to change the composition. To use AF lock, you must set an assignable button to [AF Lock] in advance.

- 1 Set an assignable button to [AF Lock] (📖 131).
- 2 While the autofocus is active, press the assignable button.
 - The focus will be locked and [AF] and the AF frame will turn gray. When you are using Face AF, the face detection frame around the main subject will turn gray.
 - Press the button again to cancel the AF lock.

i NOTES

- AF lock will be canceled automatically in the following cases:
 - If the camera is turned off or the camera's system frequency is changed.
 - If the lens is removed or replaced.
 - If [📷 Camera Setup] ➤ [Focus] ➤ [AF Mode] is changed to [One Shot].
 - If the camera is set to slow & fast motion recording mode.

Changing the AF Frame Size and Position

You can change the size and position of the AF frame that appears on the screen while using one of the autofocus functions.

- 1 Open the [AF Frame Position] submenu.
[📷 Camera Setup] ➤ [Focus] ➤ [AF Frame Position]
- 2 Select the desired option and then press SET.
- 3 Open the [AF Frame Size] submenu.
[📷 Camera Setup] ➤ [Focus] ➤ [AF Frame Size]
- 4 Select the desired option and then press SET.

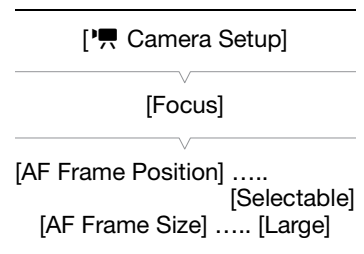

Options

[Selectable]: You can move the AF frame using the joystick or SELECT dial.

[Center Frame]: A fixed AF frame appears at the center of the screen.

[Large]: Standard AF frame size.

[Small]: Smaller AF frame size (about 1/3 the standard size).

Face Detection and Tracking

When the face detection function is activated, the camera will detect people's faces. When there are a number of people in the picture, one person will be determined to be the main subject but you have the option to select a different person as the main subject. The camera will keep tracking the main subject even when it moves.

You can use face detection with one of the autofocus functions to let the camera focus on the main subject automatically (Face AF). You can also combine face detection with the Dual Pixel Focus Guide function (📖 79) to help you focus on the main subject manually.

1 Open the [Face Det. & Tracking] submenu.

[📷 Camera Setup] ➤ [Focus] ➤ [Face Det. & Tracking]

2 Select [On] and then press SET.

3 Open the [Face AF] submenu.

[📷 Camera Setup] ➤ [Focus] ➤ [Face AF]

4 Select the desired option and then press SET.

- 📷 or 📷 will appear to the left of the screen, next to the focus mode icon.

5 Point the camera at the subject.

- A face detection frame will appear around all detected faces. The person identified as main subject will have a face detection frame with small arrows (◀▶) on the sides. If necessary, push the joystick left/right or turn the SELECT dial to change the main subject when there is more than one person.
- 📷 will appear in white when a face is detected and in gray when a face is not detected.
- During continuous AF, the camera will keep focusing on the main subject's face. During one-shot AF, the camera will focus on the main subject's face while you hold the ONE-SHOT AF button pressed down.
- If you use face detection together with the tracking function (📖 85), the camera will be able to track the selected main subject more reliably.

Options

[Face Priority] 📷: When there is no face detected, the camera focuses automatically according to the AF mode currently selected.

[Face Only] 📷: When there is no face detected, the camera locks the focus.

Face AF operation by AF mode

[📷 Camera Setup] ➤ [Focus] ➤ [AF Mode] setting and focus operation	[📷 Camera Setup] ➤ [Focus] ➤ [Face AF] setting			
	[Face Priority]		[Face Only]	
	Face detected	No face detected	Face detected	No face detected
[One Shot] while the ONE-SHOT AF button is not pressed	Manual focus			
[One Shot] while the ONE-SHOT AF button is held pressed down	Focus on the detected face	Focus on the subject inside the AF frame	Focus on the detected face	Manual focus
[AF-Boosted MF] within the automatic adjustment range			Focus on the detected face	
[AF-Boosted MF] within the manual adjustment range (yellow AF frame)	Manual focus			
[Continuous]	Focus on the detected face	Focus on the subject inside the AF frame	Focus on the detected face	Manual focus

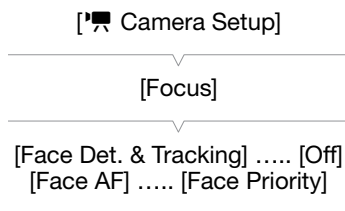







NOTES

- In certain cases, faces may not be detected correctly. Typical examples include:
 - Faces extremely small, large, dark or bright in relation to the overall picture.
 - Faces that are turned to the side, at a diagonal, partially hidden or upside-down.
- Face detection cannot be used in the following cases:
 - When the shutter speed used is slower than 1/30 (59.94 Hz recordings), 1/25 (50.00 Hz recordings) or 1/24 (24.00 Hz recordings).
 - When using slow & fast motion recording.
- The camera may mistakenly detect the faces of non-human subjects. In such case, turn face detection off.
- If you set an assignable button to [Face Det. & Tracking] ( 131), you can press the button to turn the function on and off. If you set an assignable button to [Face AF], you can press the button to toggle between the face detection options.

Tracking a Specific Subject

You can have the camera track other moving subjects that are not faces and also combine the tracking function with one of the autofocus functions to let the camera focus on the desired subject automatically. To use the tracking function, you will need to set an assignable button to [Tracking] in advance.

- 1 Set an assignable button to [Tracking] ( 131).
- 2 Activate the face detection and tracking function.
 - Steps 1 and 2 in the previous procedure ( 84).
 - If necessary, perform also steps 3 and 4, to change the [Face AF] setting according to the subject you want to track. To track a face, select [Face Only]; to track other subjects, select [Face Priority].
- 3 Press the assignable button.
 - If [Face AF] is set to [Face Only], a face detection frame will appear around all detected faces. If [Face AF] is set to [Face Priority], the subject selection mark  will appear on the screen.
 - Press the assignable button again or the CANCEL button to exit the subject selection screen.
 - If [Face AF] is set to [Face Only], the camera will automatically start tracking the main subject. Skip to step 5. If [Face AF] is set to [Face Priority], continue with step 4.
- 4 Select the subject you want to track and then press SET to start tracking it.
 - Push the joystick up/down/left/right or turn the SELECT dial to place the center of the  mark on the desired subject and then press SET. If the tracking failed, the  mark will turn red momentarily. Select the subject again.
- 5 The face detection frame or  mark changes to a tracking frame and the camera will start tracking the selected subject.
 - During continuous AF, the camera will keep focusing on the selected subject. During one-shot AF, the camera will focus on the selected subject while you hold the ONE-SHOT AF button pressed down.
 - Press SET again or press the assignable button to return to the subject selection screen and select a different subject, or press the CANCEL button to end the tracking function and return the camera to the focus mode that was used previously.

NOTES

- The camera may start tracking the incorrect subject if there is another subject in the picture with similar color/pattern characteristics. In that case, press SET to return to the selection screen and select the desired subject again.

Onscreen Markers and Zebra Patterns

Using onscreen markers allows you to make sure your subject is correctly framed and is within the appropriate safe area. The zebra patterns help you identify areas that are overexposed. The onscreen markers and zebra pattern will not affect your recordings.

Operating modes: CAMERA MEDIA

Displaying Onscreen Markers

The camera offers 5 types of onscreen markers. You can display multiple onscreen markers simultaneously.

1 Open the [Markers] submenu.

[Assistance Functions] ➔ [Markers]

2 Select a marker you wish to display, select the desired marker color and then press SET.

- Select [Off] to turn off the selected marker.
- You can display multiple markers simultaneously. Repeat this step as necessary.
- If you selected [Safe Area] or [Aspect Marker], select the desired safe area or aspect ratio with the following procedures (87) before continuing with step 3.

3 Select [Activate], select [On] and then press SET to turn on the onscreen markers.

- All of the selected onscreen markers will be displayed.
- Select [Off] to turn off all onscreen markers.

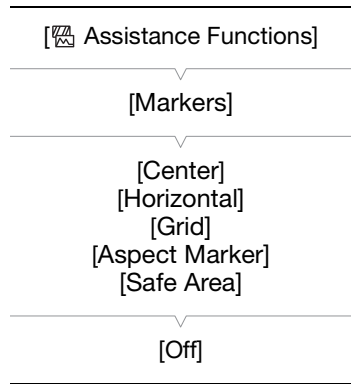

Options

- [Center]: Displays a small marker that indicates the center of the screen.
- [Horizontal]: Displays a horizontal line to help you compose level shots.
- [Grid]: Displays a grid that allows you to frame your shots correctly (horizontally and vertically).
- [Aspect Marker]: Displays markers that indicate various aspect ratios to help you keep your shot within that area. Available options for [Aspect Ratio] are [4:3], [13:9], [14:9], [16:9], [1.375:1], [1.66:1], [1.75:1], [1.85:1], [1.90:1], [2.35:1], [2.39:1] and [Custom], a free aspect ratio set by the user.
- [Safe Area] Displays indicators that show various safe areas, such as the action safe area and text safe area. You can select the core area used as the basis for calculating the safe area and a percentage ([80%], [90%], [92.5%] or [95%]), relative to that core area.

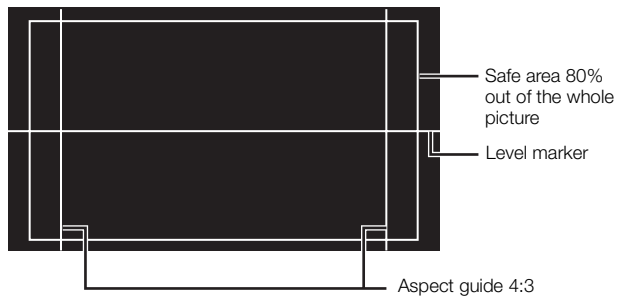
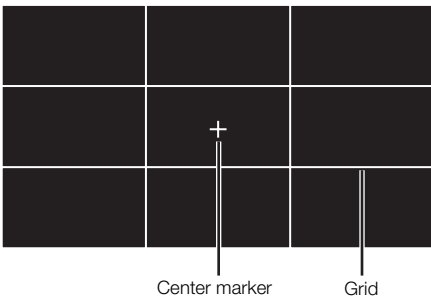

To set the aspect ratio

- 1 Select [Aspect Ratio], select the desired option and then press SET.
 - If you selected one of the preset aspect ratios, the rest of the procedure is not necessary. If you selected [Custom], continue the procedure to set the desired aspect ratio.
- 2 Select [Custom Aspect Ratio] and then press SET.
- 3 Push the joystick up/down or turn the SELECT dial to select the first digit of the aspect ratio and then press SET to move to the next.
 - Change the rest of the digits in the same way.
- 4 Select [Set] and then press SET.

To set the safe area

If an aspect marker is not selected, the safe area will be calculated as a percentage of the whole image ([Whole Picture]) and you can only select the percentage (step 2). To calculate the safe area as a percentage of an aspect ratio marker ([Selected Aspect Marker]), select an aspect ratio marker in advance and perform the procedure from the beginning.

- 1 Select [Basis for Safe Area], select the desired option and then press SET.
- 2 Select [Percentage for Safe Area], select the desired percentage and then press SET.

i NOTES

- You can turn off all other onscreen displays, leaving only the onscreen markers (📖 58).
- If you set an assignable button to [Markers] (📖 131), you can press the button to turn the onscreen markers on and off.

Displaying Zebra Patterns

The camera has a zebra pattern function that shows black and white diagonal stripes over areas that are overexposed. There are two types of zebra patterns and you can display both simultaneously. Zebra 1 lets you identify areas within a certain range ($\pm 5\%$ of a specified level) while zebra 2 lets you identify areas that are over a specified level. When you display both simultaneously and they overlap, only zebra 1 will be displayed in those areas.

- 1 Open the zebra pattern [Select] submenu.
 - [Assistance Functions] ➡ [Zebra] ➡ [Select]
- 2 Select [Zebra 1], [Zebra 2] or [Zebra 1&2] and then press SET.
- 3 Open the zebra level submenu.
 - [Assistance Functions] ➡ [Zebra] ➡ [Zebra 1 Level] or [Zebra 2 Level]
- 4 Select the desired zebra level and then press SET.
- 5 Press the ZEBRA button to activate the selected zebra pattern.
 - Alternatively, before closing the menu, you can also select [Activate], select [On] and then press SET.

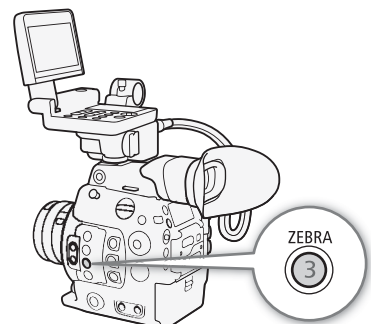
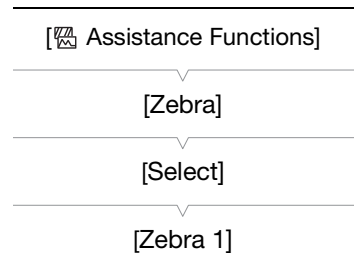

i NOTES

- You can select individually whether to display the zebra pattern on the LCD screen, the viewfinder or the MON. and HDMI OUT terminals with the display/output settings under [Assistance Functions] ➡ [Zebra]. The zebra pattern will not affect your recordings.

Setting the Time Code

In **CAMERA** mode, the camera generates a time code signal and records it with the recorded clips. The time code signal can be output from the MON. terminal, REC OUT terminal, HDMI OUT terminal and TIME CODE terminal.

In **MEDIA** mode, the time code embedded in the clip being played back can be output from the REC OUT terminal or MON. terminal.

You can also synchronize the camera's time code with an external device (📖 93, 95).

Depending on the frame rate used, you may be able to select between a drop frame and a non-drop frame time code signal (📖 89). The default mode varies depending on the country/region of purchase and, though the time code display style is different for DF and NDF, in this section the NDF display style is used for simplicity's sake.

Selecting the Time Code Mode

You can select the camera's time code mode.

Operating modes: **CAMERA** **MEDIA**

1 Open the time code [Mode] submenu.

[📺 Picture/Terminals Setup] ➡ [Time Code] ➡ [Mode]

2 Select the desired option and then press SET.

Options

[Preset]: The time code starts from an initial value you can select in advance. The default initial time code is 00:00:00.00.

See the following procedures to select the time code running mode and set the initial time code.

[Regen.]: The camera will read the selected recording media and the time code will continue from the last time code recorded on the recording media. The time code runs only while recording so clips recorded consecutively on the same recording media will have continuous time codes.

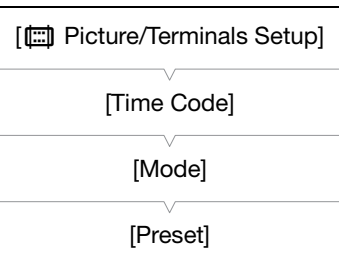

Setting the Time Code Running Mode

If you set the time code mode to [Preset], you can select the time code running mode.

1 Open the time code [Run] submenu.

[📺 Picture/Terminals Setup] ➡ [Time Code] ➡ [Run]

2 Select the desired option and then press SET.

Options

[Rec Run]: The time code runs only while recording so clips recorded consecutively on the same recording media will have continuous time codes.

[Free Run]: The time code starts running the moment you press SET and keeps running regardless of the camera's operation.

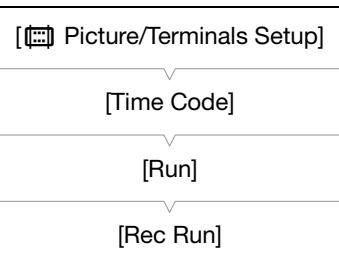

Setting the Time Code's Initial Value

If you set the time code mode to [Preset], you can set the initial value of the time code.

- 1 Open the time code [Setting] submenu.
 - [Picture/Terminals Setup] ➤ [Time Code] ➤ [Setting]
- 2 Select [Set] and then press SET.
 - The time code setting screen appears with an orange selection frame indicating the hours.
 - To reset the time code to [00:00:00.00], select [Reset] instead. If the running mode is set to [Free Run], the time code will be reset the moment you press SET and keep running continuously from 00:00:00.00.
- 3 Push the joystick up/down or turn the SELECT dial to set the hours and press SET to move to the minutes.
 - Change the rest of the fields (minutes, seconds, frame) in the same way.
 - Press the CANCEL button to close the screen without setting the time code.
- 4 Select [Set] and press SET to close the screen.
 - If the running mode is set to [Free Run], the time code will start running from the selected time code the moment you press SET.

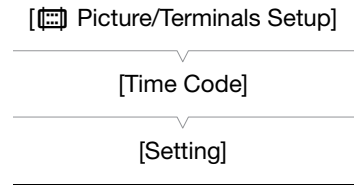

Selecting Drop or Non-Drop Frame

When the frame rate is set to 29.97P, 59.94i, or 59.94P, you can select between a drop frame (DF) or non-drop frame (NDF) time code, depending on how you plan to use your recordings.

With all other frame rates, the time code is set to non-drop frame (NDF) and cannot be changed.

Operating modes: CAMERA MEDIA

- 1 Open the [DF/NDF] submenu.
 - [Picture/Terminals Setup] ➤ [Time Code] ➤ [DF/NDF]
- 2 Select [DF] or [NDF] and then press SET.
 - The time code display will differ depending on the setting. When you select [DF], the time code will appear as [00:00:00.00]; when you select [NDF], it will appear as [00:00:00:00].

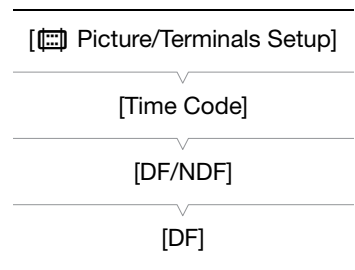

Putting the Time Code Display on Hold

If you set an assignable button to [Time Code Hold] (📖 131), you can press the button to freeze the display of the time code*. While the time code display is put on hold, [H] will appear on the screen next to the time code and [HOLD] will appear on the rear panel.

Operating modes: CAMERA MEDIA

The time code continues to run normally while the time code display is on hold. When you resume the time code display, the current time code will be displayed.



* The time code signal output from the terminals and the time code recorded on the clip when using the [OSD Recording (CFast)] function (📖 144) will not be put on hold. However, the time code displayed on a monitor connected to the HDMI OUT terminal will be put on hold.

About the Time Code Display

An icon may appear next to the time code depending on the operation. Refer to the following table.

Icon	Description
R	The time code mode is set to [Regen].
P	The time code mode is set to [Preset] and the running mode is set to [Rec Run].
F	The time code mode is set to [Preset] and the running mode is set to [Free Run].
E	Time code signal is coming from an external source.
H	Time code display is on hold.
No icon	Time code during clip playback.

NOTES

- The frames value of the time code runs from 0 to 23 (frame rate set to 23.98P or 24.00P), from 0 to 24 (frame rate set to 25.00P, 50.00i or 50.00P), or from 0 to 29 (all other frame rates).
- When you are using interval recording or frame recording, you cannot select the [Free Run] running mode. Conversely, when you are using pre-recording mode, [Free Run] is set automatically and cannot be changed.
- When you mix drop frame and non-drop frame time codes, there might be a discontinuity in the time code at the point where the recording starts.
- When you are using the [Free Run] running mode, the time code will continue running as long as the lithium button battery has some charge left, even if you disconnect all other power sources.
- If you set an assignable button to [Time Code] ( 131), you can press the button to open the [ Picture/Terminals Setup]  [Time Code] submenu.

Setting the User Bit

The user bit display can be selected from the date or the time of recording, or an identification code consisting of 8 characters in the hexadecimal system. There are sixteen possible characters: the numbers 0 to 9 and the letters A to F.

If user bit information is being received along with an external time code, you can also record the external user bit with the clip (📄 94).

Operating modes: CAMERA MEDIA

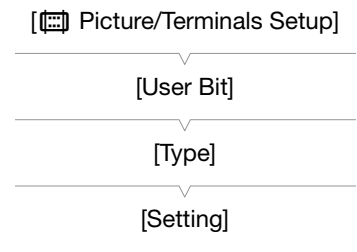

1 Open the user bit [Type] submenu.

[📷] Picture/Terminals Setup ➤ [User Bit] ➤ [Type]

2 Select the desired user bit type and press SET.

- Select [Setting] to set your own identification code, [Time] to use the time as the user bit, or [Date] to use the date as the user bit.
- If you selected [Time] or [Date], the rest of the procedure is not necessary. If you selected [Setting], continue the procedure to set the identification code.

3 Select [Set] and then press SET.

- The user bit setting screen appears with an orange selection frame on the leftmost digit.
- To reset the user bit to [00 00 00 00], select [Reset] instead.

4 Push the joystick up/down or turn the SELECT dial to select the first character and press SET to move to the next.

- Change the rest of the characters in the same way.
- Press the CANCEL button to close the screen without setting the user bit.

5 Select [Set] and press SET to close the screen.

Synchronizing with an External Device

Using Genlock synchronization, you can synchronize this camera's video signal to that of an external video device. Similarly, using an external time code signal, you can synchronize this camera's time code to the external signal. Using the external time code signal with multiple cameras allows you to set up a multi-camera recording. You can also output the time code signal from this camera to achieve the same result. If you output the time code from the REC OUT terminal or MON. terminal to an editing device, the editor can create video with the same time code.

Connecting an External Device

When synchronizing the camera using a reference video signal*, use the GENLOCK/SYNC OUT terminal. When synchronizing a time code signal, use the TIME CODE terminal. Be sure to set either terminal to input or output in advance.

Connect the external device to the camera as shown in the following diagram.

* As reference video signal (input signal) for Genlock synchronization, you can use an analog blackburst or tri-level HD signal. The reference video output signal will be a tri-level HD signal.

Connection Diagram

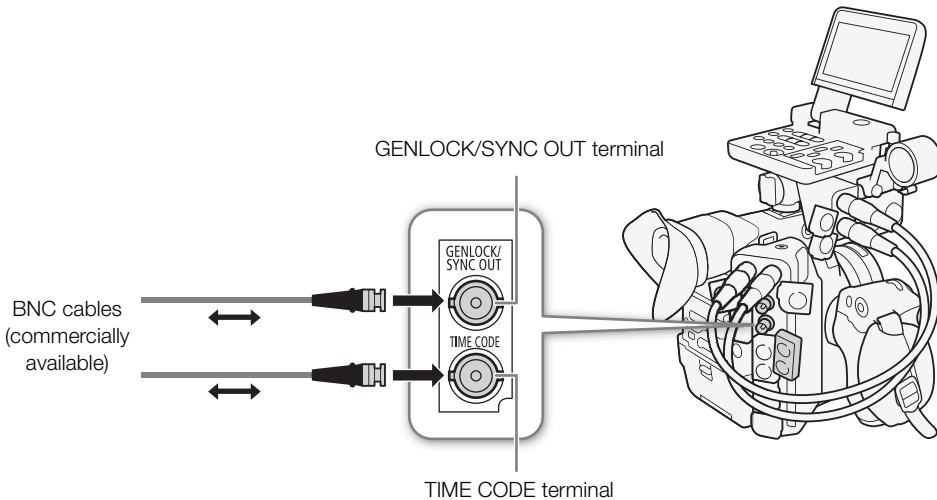

Reference Video Signal Input (Genlock Synchronization)

When a reference sync signal (analog blackburst or tri-level HD signal) is input through the GENLOCK/SYNC OUT terminal, the phases of the camera's V and H sync will automatically be synchronized to it. The phase difference between the external Genlock signal and the camera is initially set to 0. The H phase can be adjusted within the range of approximately ± 0.4 H.

Operating modes: CAMERA MEDIA

1 Open the GENLOCK/SYNC OUT terminal's [Select] submenu.

[Picture/Terminals Setup] ➤ [GENLOCK/SYNC OUT Term.] ➤ [Select]

[Picture/Terminals Setup]

2 Select [Genlock Input] and then press SET.

[GENLOCK/SYNC OUT Term.]

3 Open the [Genlock Adjustment] submenu.

[Picture/Terminals Setup] ➤ [GENLOCK/SYNC OUT Term.] ➤ [Genlock Adjustment]

[Select] [Genlock Input]
[Genlock Adjustment] [000]

4 Push the joystick up/down or turn the SELECT dial to select the value of the first field of the H phase and then press SET to move to the next.

- Change the rest of the fields in the same way to select the desired adjustment level (-1023 to 1023).

5 Select [Set] and then press SET.

NOTES

- When a suitable Genlock signal is input, the Genlock synchronization stabilizes after approximately 10 seconds.
- When a suitable Genlock signal is detected, the **Gen** icon will flash on the upper right of the screen. When the camera locks on the external Genlock signal, the icon will stay on.
- If the external Genlock signal is incorrect, the synchronization may not be stable. In such case, the recorded time code may be incorrect.

Time Code Signal Input

An external SMPTE-standard LTC timing signal received from the TIME CODE terminal will be recorded as the time code. The user bit of the external timing signal can also be recorded with clips. Before connecting the device, set the TIME CODE terminal to input with the procedure below and make sure the time code running mode is set to [Free Run] (88).

Operating modes: CAMERA MEDIA

1 Open the [TC In/Out] submenu.

[Picture/Terminals Setup] ➤ [Time Code] ➤ [TC In/Out]

2 Select [In] and then press SET.

[Picture/Terminals Setup]

[Time Code]

[TC In/Out]

[In]

Recording the User Bit of an External Signal

The user bit of an external time code signal can also be recorded with clips, along with the time code itself.

- 1 Open the user bit [Recording Mode] submenu.
[Picture/Terminals Setup] ➤ [User Bit] ➤ [Recording Mode]
- 2 Select [External] and then press SET.

NOTES

- Synchronize the camera's time code with an external time code signal that matches the camera's system frequency. Use a 24-frame time code signal when the frame rate is set to 23.98P or 24.00P, a 25-frame time code signal when it is set to 25.00P, 50.00i or 50.00P and a 30-frame time code signal for other frame rates.
- When a suitable external time code signal is received, the camera's own time code will be synchronized to it and the synchronization will be maintained even if you disconnect the cable from the TIME CODE terminal.
- When the camera locks on an external time code signal, [EXT-LOCK] appears on the rear panel.
- If the external time code signal is incorrect or there is no input signal, the internal time code set in the [Picture/Terminals Setup] ➤ [Time Code] submenu will be recorded instead.
- While a DF time code signal is being received, the external time code's drop-frame bit will be used. If the external time code is non-drop frame, [NDF] will appear on the rear panel.
- Performing any of the following actions while the cable is not connected will cause the synchronization to be disrupted; the correct time code will be restored once you reconnect the cable.
 - Turning the camera off or changing the operating mode to MEDIA mode
 - Changing the video configuration

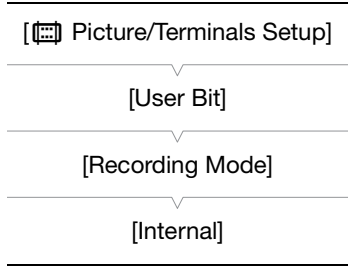

Reference Video Signal Output

You can output the camera's video signal as a reference sync signal (tri-level HD signal) to synchronize an external device to this camera. The reference video signal output will have the same frequency as the signal output from the REC OUT terminal.

Operating modes: CAMERA MEDIA

1 Open the GENLOCK/SYNC OUT terminal's [Select] submenu.

[Picture/Terminals Setup] ➤ [GENLOCK/SYNC OUT Term.] ➤ [Select]

2 Select [HD Sync Output] and then press SET.

- If necessary, change the scan mode (P or PsF) with the [Picture/Terminals Setup] ➤ [GENLOCK/SYNC OUT Term.] ➤ [SYNC Scan Mode] setting.

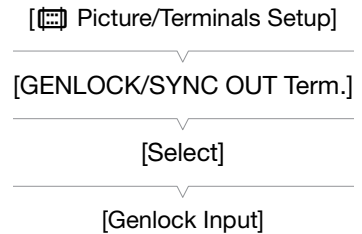

Synchronization signals

Video output from the REC OUT terminal		Signal output from the SYNC OUT terminal (tri-level HD signal)
Resolution	Frame rate	
4096x2160 3840x2160 2048x1080 1920x1080	29.97P	1080/29.97 (P/PsF)
	25.00P	1080/25.00 (P/PsF)
	24.00P	1080/24.00 (P/PsF)*
	23.98P	1080/23.98 (P/PsF)
2048x1080 1920x1080	59.94i / 59.94P	1080/59.94i
	50.00i / 50.00P	1080/50.00i

* When the camera is set to slow & fast motion recording mode ([Slow & Fast Motion]) and the shooting frame rate is set to 1 to 30 (fps), the signal output will be 1080/30.00 (P/PsF); when the shooting frame rate is set to 31 to 60 (fps), it will be 1080/60.00i. When the camera is set to slow & fast motion recording in crop mode ([Slow & Fast Motion (crop)]), the signal output will always be 1080/60.00i.

Time Code Signal Output

The time code will be output from the TIME CODE terminal as a SMPTE-standard LTC timing signal. The user bit will also be output. Additionally, the time code will be output from the MON. terminal, REC OUT terminal, and, if you set [Recording/Media Setup] ➤ [HDMI Time Code] to [On], also from the HDMI OUT terminal (except during interval recording, frame recording or slow & fast motion recording).

Before connecting the external device, set [Picture/Terminals Setup] ➤ [Time Code] ➤ [TC In/Out] to [Out] to change the TIME CODE terminal's function to output (93).

Operating modes: CAMERA MEDIA

Recording Audio

The camera features 4-channel linear PCM audio recording and playback. The sampling frequency is 48 kHz and the audio sampling bit depth can be selected between 24 bit or 16 bit. You can record audio using commercially available microphones (INPUT terminals, MIC terminal), analog line input (INPUT terminals) or the built-in monaural microphone*.

An audio signal will also be output with the video signal from the REC OUT terminal, MON. terminal and HDMI OUT terminal. You can record this audio signal on an external recorder.

* Only for recording notes while shooting.

Operating modes: CAMERA MEDIA

Audio Settings and Recorded Audio Channels

Which audio inputs are recorded to which audio channels is determined by a combination of menu settings, audio-related controls on the camera and whether an external microphone is connected to the MIC terminal. The following table gives an overview of the possible combinations.

INPUT terminals enabled ¹	MIC terminal used	[CH2 Input] setting ²	Recorded audio channels/audio sources			
			CH1	CH2	CH3	CH4
Yes	Yes	[INPUT 2]	INPUT 1 terminal	INPUT 2 terminal	MIC terminal (L)	MIC terminal (R)
		[INPUT 1]	INPUT 1 terminal	INPUT 1 terminal		
	No	[INPUT 2]	INPUT 1 terminal	INPUT 2 terminal	Built-in microphone (mono)	Built-in microphone (mono)
		[INPUT 1]	INPUT 1 terminal	INPUT 1 terminal		
No	Yes	–	MIC terminal (L)	MIC terminal (R)		
	No	–	Built-in microphone (mono)	Built-in microphone (mono)		

¹ The camera's AUDIO terminal is correctly connected to the AUDIO terminal on the supplied monitor unit or the optional MA-400 Microphone Adapter.

² [🎵] Audio Setup ➤ [Audio Input] ➤ [CH2 Input].

NOTES

- On the [Audio] status screen (📖 195), you can check the audio level adjustment mode and input source for each of the audio channels.

Selecting the Audio Bit Depth

- 1 Open the [Audio Bit Depth] submenu.
[🎵] Audio Setup ➤ [Audio Input] ➤ [Audio Bit Depth]
- 2 Select 24 or 16 bits per sample and then press SET.

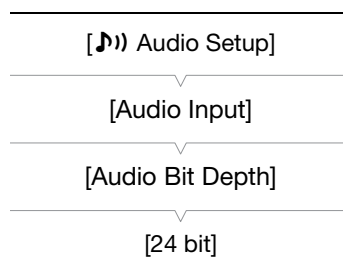

Connecting an External Microphone or External Audio Input Source to the Camera

To each of the INPUT terminals you can attach commercially available microphones or analog line in sources with an XLR connector. To the MIC terminal you can attach commercially available condenser microphones with their own power supply, and a \varnothing 3.5 mm stereo mini plug.

In order to use the INPUT terminals, the supplied monitor unit or optional MA-400 Microphone Adapter* must be correctly attached to the camera. These units have a microphone holder where you can fix external microphones with a diameter of 19 mm to 20 mm.

* Like the monitor unit, the MA-400 can be attached to the camera's body or handle unit, but it offers only audio terminals and controls.

Follow the procedure below to attach a microphone (refer also to the following illustration). To connect an external device to the camera, plug the device's cable into the desired INPUT terminal (4).

- 1 Loosen the microphone lock screw (1), open the microphone holder and insert the microphone (2).
- 2 Tighten the lock screw and put the microphone cable through the cable clamp under the microphone holder (3).
- 3 Plug the microphone cable into the desired INPUT terminal (4) or the MIC terminal (5).

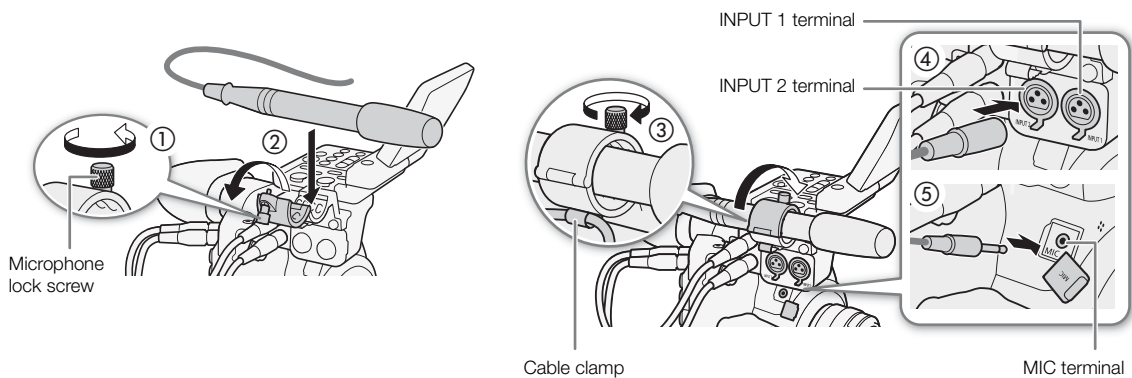

Using the INPUT 1/INPUT 2 Terminals

Using the INPUT 1/INPUT 2 terminals, you can record audio independently to two audio channels from a microphone or analog audio input source.

To select the audio source, set the INPUT 1 or INPUT 2 switch to LINE or MIC as necessary.

- To supply a microphone with phantom power, set the switch to MIC+48V instead. Make sure to connect the microphone first, before turning the phantom power on. Keep the microphone connected when turning off the phantom power.
- When using the INPUT terminals to record to only one channel, use the INPUT 1 terminal.

! IMPORTANT

- When connecting a microphone or device that does not support phantom power, make sure to set the corresponding INPUT switch to MIC or LINE, respectively. If you set the switch to MIC+48V, the microphone or device may be damaged.

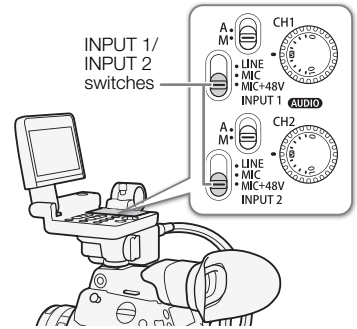

Recording a Single Audio Input to Two Audio Channels

By default, each audio input is recorded to a separate audio channel (INPUT 1 to CH1 and INPUT 2 to CH2). If necessary (for example, as an audio backup recording), you can record the audio input into the INPUT 1 terminal to both audio channels, CH1 and CH2. In that case, you can adjust the audio recording levels of each channel independently of each other.

1 Open the [CH2 Input] submenu.

[J) Audio Setup] ➤ [Audio Input] ➤ [CH2 Input]

2 Select the desired option and then press SET.

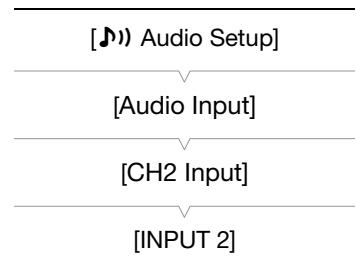

Options

[INPUT 2]: Records audio to each channel separately. Audio input into INPUT 1 is recorded to CH1, while audio input into INPUT 2 is recorded to CH2.

[INPUT 1]: Audio input into INPUT 1 is recorded to both channels. Audio input into INPUT 2 will not be recorded.

Adjusting the Audio Level from the INPUT 1/INPUT 2 Terminals

You can set the audio recording level for audio input from the INPUT terminals to automatic or manual level, independently for each channel.

Automatic Audio Level Adjustment

Set the audio level switch of the desired channel to A (automatic) to let the camera automatically adjust that channel's audio level.

i NOTES

- When both CH1 and CH2 are set to the same audio source (external microphone or external line input), if the audio level is set to automatic, you can use the [M] Audio Setup ➤ [Audio Input] ➤ [INPUT 1&2 ALC Link] setting to link the audio level adjustment of both channels.

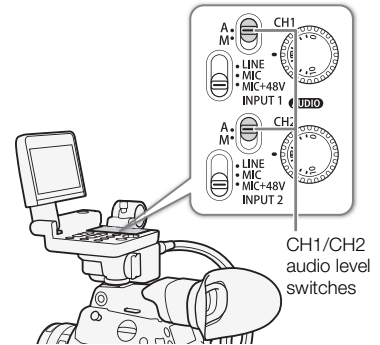

Manual Audio Level Adjustment

You can set the audio level for each channel manually from $-\infty$ to +18 dB.

- Set the audio level switch of the desired channel to M (manual).
- Turn the corresponding **AUDIO** dial to adjust the audio level.
 - For reference, the 0 corresponds to $-\infty$, 5 corresponds to 0 dB, and 10 corresponds to +18 dB.
 - As a guideline, adjust the audio recording level so that the audio level meter on the screen or rear panel will go to the right of the -18 dB mark (one mark right of the -20 dB mark) only occasionally.
 - Closing the protective cover will prevent the audio controls from being changed inadvertently.

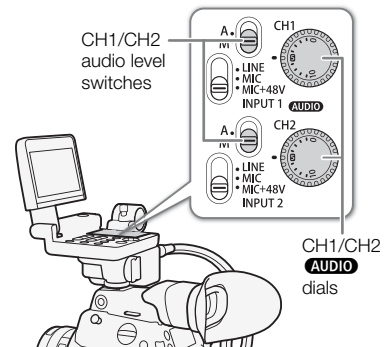

i NOTES

- If at least one of the channels is set to manual audio level adjustment, you can also activate the audio peak limiter to prevent audio distortions. When activated, the audio peak limiter will limit the amplitude of audio input signals when they exceed approximately -6 dBFS. Use the [M] Audio Setup ➤ [Audio Input] ➤ [INPUT 1&2 Limiter] setting.
- We recommend using headphones when adjusting the audio level. If the input level is too high, audio may become distorted even if the audio level indicator shows an appropriate level.
- If you set an assignable button to [Audio Level] (131), you can press the button to turn the onscreen audio level indicator on and off.

Adjusting the Microphone's Sensitivity

When the INPUT 1 or INPUT 2 switch is set to MIC or MIC+48V, you can select the external microphone's sensitivity.

- Open the desired INPUT terminal's sensitivity submenu.

[M] Audio Setup ➤ [Audio Input] ➤ [INPUT 1 Mic Trimming] or [INPUT 2 Mic Trimming]
- Select the desired level and then press SET.
 - You can select one of 5 sensitivity levels from -12 dB to +12 dB.

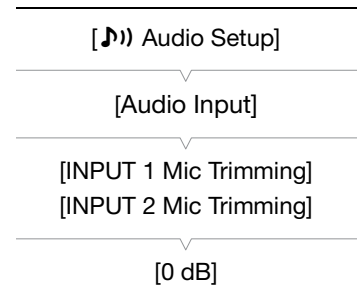

Activating the Microphone's Attenuator

When the INPUT 1 or INPUT 2 switch is set to MIC or MIC+48V, you can activate the external microphone's attenuator (20 dB).

1 Open the desired INPUT terminal's microphone attenuator submenu.

[J) Audio Setup] ➤ [Audio Input] ➤ [INPUT 1 Mic Att.] or [INPUT 2 Mic Att.]

2 Select [On] and then press SET.

[J) Audio Setup]

[Audio Input]

[INPUT 1 Mic Att.]

[INPUT 2 Mic Att.]

[Off]

Using the MIC Terminal

You can set the audio recording level of a microphone attached to the MIC terminal to automatic or manual level. With manual audio level adjustment, you can set the audio level within a range of 0 to 99.

1 Open the [MIC Mode] submenu.

[J) Audio Setup] ➤ [Audio Input] ➤ [MIC Mode]

2 Select [Automatic] or [Manual] and then press SET.

- If you selected [Automatic], the rest of the procedure is not necessary. If you selected [Manual], continue the procedure to set the microphone's audio recording level.

3 Open the [MIC Level] submenu.

[J) Audio Setup] ➤ [Audio Input] ➤ [MIC Level]

4 Push the joystick up/down or turn the SELECT dial to set the audio recording level and then press SET.

- For reference, 0 corresponds to $-\infty$, 50 corresponds to 0 dB, and 99 corresponds to +18 dB.
- As a guideline, adjust the audio recording level so that the audio level meter on the screen or rear panel will go to the right of the -18 dB mark (one mark right of the -20 dB mark) only occasionally.

NOTES

- We recommend using headphones when adjusting the audio level. If the input level is too high, audio may become distorted even if the audio level indicator shows an appropriate level.

Activating the Low-Cut Filter

You can activate the low-cut filter, for example to reduce the sound of wind in the background when recording outdoors.

1 Open the [MIC Low Cut] submenu.

[J) Audio Setup] ➤ [Audio Input] ➤ [MIC Low Cut]

2 Select [On] or [Off] and then press SET.

- When you select [On], some low-frequency sounds may be suppressed along with the sound of wind.

[J) Audio Setup]

[Audio Input]

[MIC Low Cut]

[Off]

Activating the Microphone's Attenuator

If the audio level is too high and the sound sounds distorted, activate the microphone attenuator (20 dB).

- 1 Open the [MIC Att.] submenu.
[🎵] Audio Setup ➤ [Audio Input] ➤ [MIC Att.]
- 2 Select [On] and then press SET.



101

About the monaural microphone

The monaural microphone allows you to add comments while shooting, which can be synchronized to the audio and video during editing. The monaural microphone is available when neither the supplied monitor unit nor the optional MA-400 Microphone Adapter is connected to the camera.

i NOTES

- The audio recording level of the monaural microphone cannot be changed.

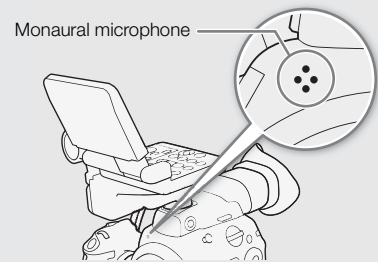

Monitoring the Audio with Headphones

Connect headphones with a Ø 3.5 mm stereo mini-plug to the  (headphone) terminal to monitor the recorded audio.

i NOTES

- You can adjust the headphone volume with the [🎵] Audio Setup] ➤ [Audio Output] ➤ [Headphone Volume] setting. If you set an assignable button to [Headphones +] or [Headphones -] ( 131), you can press the button to adjust the headphone volume without using the menu.

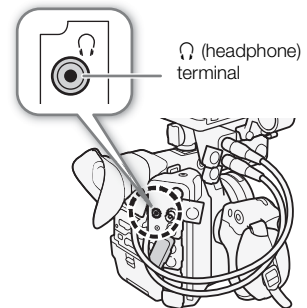

Colors Bars/Audio Reference Signal

You can have the camera generate color bars and a 1 kHz audio reference signal and output them from the REC OUT terminal*, MON. terminal, HDMI OUT terminal and Ω (headphone) terminal*. The color bars can also be displayed on the LCD screen and viewfinder.

* Audio reference signal only.

Operating modes: CAMERA MEDIA

Color Bars

The camera offers 3 types of color bars.

1 Open the [Activate] submenu to activate the color bars.

[Camera Setup] \blacktriangleright [Color Bars] \blacktriangleright [Activate]

2 Select [On] and then press SET.

- The selected color bars appear on the screen.
- Pressing the START/STOP button, turning off the camera or changing the operating mode to MEDIA mode will deactivate the color bars.

3 Open the color bars [Type] submenu.

[Camera Setup] \blacktriangleright [Color Bars] \blacktriangleright [Type]

4 Select the type of color bars and then press SET.

NOTES

- If you set an assignable button to [Color Bars] (131), you can press the button to turn the color bars on/off.
- When [Recording/Media Setup] \blacktriangleright [Rec Command] is set to [On], the color bars will not be output from the MON. terminal or HDMI OUT terminal (except during record standby mode).

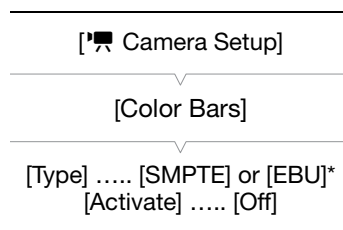

* Depending on the country/region of purchase.

Audio Reference Signal

The camera can output a 1 kHz audio reference signal with the color bars.

1 Open the [1 kHz Tone] submenu.

[Audio Setup] \blacktriangleright [Audio Input] \blacktriangleright [1 kHz Tone]

2 Select the desired level and then press SET.

- Available levels are -12 dB, -18 dB and -20 dB.
- Select [Off] to turn off the signal.
- The signal is output at the selected level.

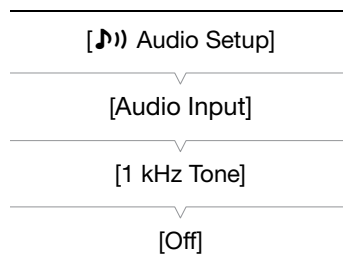

Video Scopes

The camera can display a simplified waveform monitor. You can select one of 6 types of monitors and also adjust the waveform amplification.

Operating modes: CAMERA MEDIA

Displaying the Waveform Monitor

Press the WFM button.

- The waveform monitor window will appear on the right of the screen.
- Alternatively, you can display the video scopes using [ Assistance Functions] ➤ [WFM] ➤ [Activate] setting.

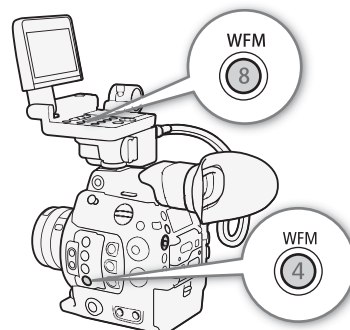

Configuring the Waveform Monitor

1 Open the waveform monitor's [Type] submenu.

[ Assistance Functions] ➤ [WFM] ➤ [Waveform Monitor] ➤ [Type]

2 Select the desired option and then press SET.

- If you selected [Select Line], continue the procedure to set the Y coordinate of the line you wish to display. Otherwise, skip to step 5 to change the gain.

3 To select the line's Y coordinate, open the waveform monitor's [Select Line] submenu.

[ Assistance Functions] ➤ [WFM] ➤ [Waveform Monitor] ➤ [Select Line]

4 Push the joystick up/down or turn the SELECT dial to select the first digit of the Y coordinate and then press SET to move to the next.

- Change the rest of the digits in the same way to select the Y coordinate of the desired line.
- When the number of horizontal lines (vertical component) of the resolution used is 1080, you can select a value between 0 and 1079 (1-line increments); when the vertical resolution is 2160, you can select a value between 0 and 2158 (2-line increments).

5 Select [Set] and then press SET.

6 Open the waveform monitor [Gain] submenu.

[ Assistance Functions] ➤ [WFM] ➤ [Waveform Monitor] ➤ [Gain]

7 Select the desired amplification ratio and then press SET.

- If you selected [1x], the rest of the procedure is not necessary. If you selected [2x], the display range of the waveform monitor's Y axis will be reduced by half. Continue the procedure to select the minimum luminance value (in %) shown on the Y axis.

[ Assistance Functions]

[WFM]

[Waveform Monitor]

[Type] [Line]
[Gain] [1x]

8 Open the waveform monitor [Y Position] submenu.

[ Assistance Functions] ➤ [WFM] ➤ [Waveform Monitor] ➤ [Y Position]

9 Select the desired percentage and then press SET.

104

Options

- [Line]: Sets the waveform monitor to line display mode.
- [Line+Spot]: The waveform of the area in the red frame is displayed in red on top of the [Line] mode waveform.
- [Select Line]: The selected horizontal line will be displayed along with its waveform.
- [Field]: Sets the waveform monitor to field display mode.
- [RGB]: Functions like an RGB parade scope.
- [YPbPr]: Functions like a YPbPr parade scope.

NOTES

- You can choose to display the waveform monitor on the LCD screen or viewfinder or output it to the MON. and HDMI OUT terminals (together) with the [ Assistance Functions] ➤ [WFM] ➤ [Output] setting.
- The waveform monitor will not be affected even if a LUT is applied to the LCD screen and viewfinder.

Adding Marks while Recording

When recording, you can flag an important shot in a clip (only primary clips recorded on a CFast card) by adding a “shot mark” (S). There are two types of shot marks, shot mark 1 (S1) and shot mark 2 (S2), and you can add either or both types to a single clip. You can also add an OK mark (OK) or check mark (✓) to the entire clip to flag clips you want to set apart. You can also perform this function remotely using Browser Remote on a connected Wi-Fi device (☞ 120, 122).

When the camera is in **MEDIA** mode, you can add or delete shot marks (☞ 158). You can also display an index screen of all the shot marks (☞ 157), allowing you to find a particular scene in a clip more quickly.

Operating modes: **CAMERA** **MEDIA**

Adding Shot Marks while Recording

To add a shot mark to a clip while recording, you must first set in advance an assignable button to [Add Shot Mark 1] or [Add Shot Mark 2].

1 Set an assignable button to [Add Shot Mark 1] or [Add Shot Mark 2] (☞ 131).

- To add both shot marks, set one assignable button to [Add Shot Mark 1] and another assignable button to [Add Shot Mark 2].

2 While you are recording, press the assignable button at the beginning of the shot you wish to mark.

- A message indicating the shot mark will appear and the selected shot mark will be added to the current frame of the clip.

i NOTES

- Up to 100 shot marks (S1 and S2 marks combined) can be added to a single clip.
- There may be up to a 0.5 second delay from when you press the button to when the camera adds the shot mark.
- When you are using interval recording or frame recording mode, you cannot add shot marks to a clip.
- When a clip contains either shot mark, S will appear next to the clip’s thumbnail in the playback index screen.

Adding an OK Mark or ✓ Mark while Recording

While recording an important primary clip on a CFast card, you can add an OK mark (OK) or check mark (✓) to the clip to flag it and set it apart. When the camera is in **MEDIA** mode, you can display an index screen that contains only clips with an OK mark or only clips with a ✓ mark (☞ 148). Furthermore, you can use the OK mark to protect important clips, as clips with an OK mark cannot be deleted.

To add an OK mark or ✓ mark to a clip while recording, you must first set in advance an assignable button to [Add OK Mark] or [Add ✓ Mark].

1 Set an assignable button to [Add OK Mark] or [Add ✓ Mark] (☞ 131).

- To add both types of clip marks (to different clips), set one assignable button to [Add OK Mark] and another assignable button to [Add ✓ Mark].

2 While you are recording, press the assignable button.

- A message indicating the clip mark will appear and the selected clip mark will be added to the clip.

i NOTES

- A clip cannot have both an OK mark and a ✓ mark at the same time.

Using Metadata

The camera automatically adds metadata to clips while they are being recorded. You can use Canon XF Utility for XF-AVC to check and search for specific metadata. You can also create and transfer a user memo remotely using Browser Remote on a connected Wi-Fi device (📖 120, 128).

Metadata components

Metadata	Entering content			Checking content
	Camera	Canon XF Utility for XF-AVC	Browser Remote	Canon XF Utility for XF-AVC
User Memo: clip title, creator, location and description.	–	● ¹	●	●
GPS information: altitude, latitude and longitude.	● ²	● ³	●	●
Information about the recording: scene and take.	●	–	–	●
Information about camera settings: shutter speed, ISO speed/gain value, etc.	– ⁴	–	–	●
Unique Material Identifiers (UMID): country, organization and user codes based on the SMPTE standard.	● (📖 184)	–	–	–

¹ User memo files need to be created using the software and saved on an SD card in advance.

² Only when an optional GP-E1 GPS Receiver is attached to the camera. While recording, GPS information is recorded automatically by the camera (📖 108).

³ GPS information can only be added to clips already recorded.

⁴ Recording data is logged automatically by the camera.

Operating modes: CAMERA MEDIA

Setting a User Memo Created with Canon XF Utility for XF-AVC

Before you can add a user memo, you must first install Canon XF Utility for XF-AVC (📖 170). Next, create the user memo and then save it to an SD card. Once you insert the SD card in the camera and select the user memo, it will be added to clips you record.

For details on using the software, refer to the instruction manual that is installed with Canon XF Utility for XF-AVC (📖 171).

1 Use Canon XF Utility for XF-AVC to save a user memo to an SD card.

- For details, refer to *Managing User Memo Profiles* in the Canon XF Utility for XF-AVC Instruction Manual.

2 Insert the SD card into the camera's SD card slot.

3 Open the metadata [Setting] submenu.

[🔧 Recording/Media Setup] ➤ [Metadata] ➤ [Setting]

4 Select [SD Card] and then press SET.

5 Open the [User Memo] submenu.

[🔧 Recording/Media Setup] ➤ [Metadata] ➤ [User Memo]

6 Select the file name of the desired user memo and then press SET.

- The **MEMO** icon appears on the right of the screen.
- Select [Off] to record clips without a user memo.

[🔧 Recording/Media Setup]

[Metadata]

[Setting]

[SD Card]

[🔧 Recording/Media Setup]

[Metadata]

[User Memo]

NOTES

- After you set a user memo, do not remove the SD card while you are recording. If the SD card is removed, the user memo will not be added to the clip.
- You must set the user memo before you start recording for it to be added to the clip. You cannot change the user memo already added to a clip using the camera but you can do so with Canon XF Utility for XF-AVC.
- When the optional GP-E1 GPS Receiver is attached to the camera and the GPS function is activated, the user memo information will not be recorded, even if you have selected a user memo file from the SD card.

Entering Information About the Recording

You can enter scene and take information to help identify the recording later on.

1 Open the [Scene] or [Take] submenu.

 [Recording/Media Setup] ➤ [Metadata] ➤ [Scene] or [Take].

2 Select [Set] and then press SET.

- Enter the desired text using the keyboard screen ( 35).
- To clear the scene/take information, select [Reset] instead.

3 Select [OK] and then press SET.

 [Recording/Media Setup]

▼
[Metadata]

▼
[Scene] [(NONE)]

[Take] [(NONE)]

Recording GPS Information (Geotagging)

When the optional GP-E1 GPS Receiver is attached to the camera's system extension terminal, the camera will automatically record GPS information (latitude, longitude and altitude) as part of the clip's metadata (106). Later, the GPS information can be used to organize and search clips using Canon XF Utility for XF-AVC (170). In **MEDIA** mode, you can check if a clip contains GPS information on the [Clip Info] screen (153). For details about attaching and configuring the receiver, refer to the GP-E1's instruction manual.

Attaching the GPS Receiver

Turn off the camera and attach the optional GP-E1 GPS Receiver to the camera's system extension terminal.



Activating the GPS Receiver

Operating modes: **CAMERA** **MEDIA**

1 Open the GPS [Activate] submenu.

[f System Setup] ➤ [GPS] ➤ [Activate]

2 Select [On] and then press SET.

- The  icon appears on the right of the screen and will flash as the receiver tries to acquire satellite signals.
- When satellite signals are correctly acquired, the  icon will stay continuously on. GPS functions will be activated and clips recorded thereafter will be geotagged.

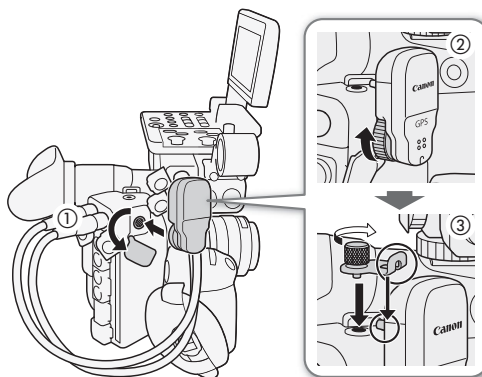

[f System Setup]

[GPS]

[Activate]

[Off]

Adjusting the Date/Time Automatically According to GPS Position

Setting the [f System Setup] ➤ [GPS] ➤ [Auto Time Setting] to [On], you can have the camera automatically adjust its date and time settings according to the information received from the GPS signal while an optional GP-E1 GPS Receiver is attached to the camera.

- When [f System Setup] ➤ [Auto Time Setting] is set to [On], [f System Setup] ➤ [Time Zone] and [Set Clock] submenus will not be available.

! IMPORTANT

- In certain countries/regions, the use of GPS may be restricted. Be sure to use the GPS receiver in accordance with local laws and regulations of the country/region where the receiver is used. Be particularly careful when traveling outside of your home country.
- Be careful about using the GPS receiver in places where the use of electronic devices is restricted.
- The GPS information recorded with clips may contain data that can lead others to locate or identify you. Be careful when sharing geotagged recordings with others or when uploading them to the Web.
- Do not leave the GPS receiver near strong electromagnetic fields such as near powerful magnets and motors.

 NOTES

- On the [GPS Information Display] status screen ( 198), you can check the current GPS information and satellite signal strength.
- GPS signal reception may take some time after replacing the battery pack or when first turning on the camera.
- GPS information will not be recorded with still frames grabbed from a clip.

Reviewing a Recording

If you set an assignable button to [Review Recording] in advance, you can review all or part of the last clip recorded even with the camera set to **CAMERA** mode.

Operating modes: **CAMERA** **MEDIA**

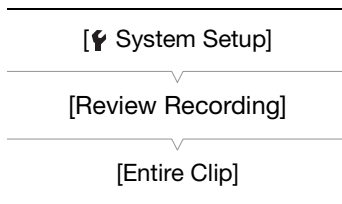

1 Set an assignable button to [Review Recording] in advance (📖 131).

2 Open the [Review Recording] submenu to set the review length.

[System Setup] ➤ [Review Recording]

3 Select the desired option and then press SET.

4 After you finish recording a clip, press the assignable button.

- The last clip that was recorded is played back for the selected duration. [REVIEW] appears at the top of the screen.
- You can push the joystick left/right during the playback to skip 10 seconds backward or forward, respectively. When there are less than 10 seconds from the start of the clip, pushing the joystick left will start playing back the clip from the beginning. When there are less than 4 seconds from the end of the clip, pushing the joystick right will have no effect.
- Press the assignable button again or the CANCEL button to stop reviewing the clip and return the camera to record standby mode.
- After the clip finishes playing back, the camera returns to record standby mode.

Options

[Entire Clip]: Allows you to review the entire clip.

[Last 4 sec]: Allows you to review just the last 4 seconds of the clip.

NOTES

- If the camera switched CFast cards during a recording, the camera will play back the clip on the CFast card most recently recorded on.

Simultaneous Recording of Proxy Clips

In addition to the primary clip recorded on a CFast card, you can simultaneously record the same scene as a proxy clip on an SD card. Compared to 4K clips, proxy clips have a relatively more manageable video configuration of 2K with YCbCr 4:2:0, 8-bit color sampling and a bit rate of 24 Mbps or 35 Mbps*, which makes them very convenient for offline editing. Additionally, by specifying a LUT, you can obtain proxy clips with different color space/gamma characteristics from those of the primary clips.

* Determined automatically depending on the video configuration of the primary clip.

Operating modes: CAMERA MEDIA

Video configuration of proxy clips

Video configuration of primary clips		Video configuration of proxy clips ¹		
Resolution	Frame rate	Resolution	Color sampling	Bit rate and compression ²
4096x2160	29.97P, 25.00P, 24.00P, 23.98P	2048x1080	YCbCr 4:2:0 8 bit	24 Mbps, Long GOP
2048x1080		1920x1080		
3840x2160	59.94i, 50.00i	1920x1080		35 Mbps, Long GOP
1920x1080		2048x1080		
1920x1080	59.94P, 50.00P	2048x1080		35 Mbps, Long GOP
2048x1080		1920x1080		

¹ The frame rate and audio recording settings will be the same as those used for primary clips.

² The camera uses a variable bit rate (VBR).

1 Open the proxy recording [Activate] submenu.

[📷 Recording/Media Setup] ➡ [XF-AVC Proxy Recording] ➡ [Activate]

[📷 Recording/Media Setup]

2 Select [On] and then press SET.

[XF-AVC Proxy Recording]

3 To apply a LUT to proxy clips, open the proxy recording [Apply LUT] submenu.

[📷 Recording/Media Setup] ➡ [XF-AVC Proxy Recording] ➡ [Apply LUT]

[Activate] [Off]
[Apply LUT] [Off]

4 Select the desired LUT and then press SET.

5 Press the START/STOP button to start and stop recording.

- A proxy clip will be recorded on the SD card at the same time the primary clip is recorded on the CFast card.

! IMPORTANT

- Observe the following precautions while an access indicator is illuminated in red. Failure to do so may result in permanent data loss.
 - Do not open the card slot cover of the card being accessed and do not remove the card.
 - Do not disconnect the power source or turn off the camera.

i NOTES

- If the recording of the primary clip stops during simultaneous recording, recording of the proxy clip will stop as well.
- During interval recording, frame recording or slow & fast motion recording, proxy clips will not be recorded.
- During relay recording, if the camera switches from recording on one CFast card to the other, the recording of the proxy clip will be interrupted as well and continue as a separate proxy clip.
- When an SD or SDHC card is used to record proxy clips, the video (stream) file in a proxy clip will be split approximately every 4 GB for clips with long recording times. Still, playback on the camera will be continuous.

- Available LUT options may vary depending on the current gamma curve and color space settings in the custom picture file (📖 134). Also, when those settings are changed, the LUT will be removed ([Apply LUT] will be reset to [Off]).
- If proxy clip recording is activated but no CFast card is inserted in the camera, only the proxy clip will be recorded on the SD card.

Special Recording Modes

The camera features the following special recording modes.

Slow & fast motion recording: This mode allows you to change the shooting frame rate to achieve a slow motion or fast motion effect during playback.

Pre-recording: The camera will start recording a few seconds before you press the START/STOP button. This is especially useful when it is difficult to predict when to start recording.

Frame recording: The camera will record a pre-defined number of frames every time you press the START/STOP button. This mode is suitable for recording stop motion animation.

Interval recording: The camera will automatically record a pre-defined number of frames at a pre-defined interval. This mode is suitable for recording subjects with little movement, such as natural surroundings or plants.

Operating modes: CAMERA MEDIA

Slow & Fast Motion Recording Mode

The camera can record using a progressive frame rate (shooting frame rate) that is different from the playback frame rate. Recording a clip at a higher frame rate than the [Frame Rate] setting will result in a slow motion effect during playback (up to 1/2.5 of the original speed). Conversely, a lower frame rate will result in a fast motion effect (up to 60x the original speed). Sound is not recorded in this mode.

Available shooting frame rates

Frame rate	Video configuration		Shooting frame rate ² (fps)
	Vertical resolution	Color sampling ¹	
59.94P	1080	YCC422 10 bit	1 to 60
	1080 (cropped) ³		1 to 120
29.97P, 24.00P, 23.98P	2160	YCC422 10 bit	1 to 30
	1080	RGB444 10 bit, RGB444 12 bit	
			YCC422 10 bit
	1080 (cropped) ³	YCC422 10 bit	1 to 120
50.00P	1080	YCC422 10 bit	1 to 50
	1080 (cropped) ³		1 to 100
25.00P	2160	YCC422 10 bit	1 to 25
	1080	RGB444 10 bit, RGB444 12 bit	
			YCC422 10 bit
	1080 (cropped) ³	YCC422 10 bit	1 to 100

¹ Part of the [Recording/Media Setup] ► [Resolution/Color Sampling] setting.

² Between 1 and 30 (fps), in 1-fps increments; between 32 and 60 (fps), in 2-fps increments; between 64 and 120 (fps), in 4-fps increments.

³ This range is available only for slow & fast motion recording in crop mode.

Pre-recording Mode

When pre-recording mode is activated, the camera starts recording continuously into a temporary memory (approx. 3 seconds) so when you press the START/STOP button, the clip will contain also a few seconds of video and audio recorded before you pressed the button.

1 Open the [Recording Mode] submenu.

[ Recording/Media Setup] ➤ [Recording Mode]

2 Select [Pre-Recording] and then press SET.

- [PRE REC STBY] appears at the top of the screen.

3 Press the START/STOP button to begin recording.

- The tally lamp illuminates.
- [PRE REC STBY] changes to [● PRE REC] while recording.

4 Press the START/STOP button again to stop recording.

- The camera records the clip, including a few seconds of video and audio recorded before the START/STOP button was pressed.
- The tally lamp goes out and [PRE REC STBY] appears at the top of the screen.

5 When you have finished recording, turn off the special recording mode.

- Repeat steps 1 and 2 selecting [Normal Recording] instead.

NOTES

- About the time code during pre-recording mode:
 - The time code of the clip will start a few seconds before the START/STOP button was pressed.
 - The time code will be recorded with the running mode set to [Free Run].
 - If the time code mode was set to [Regen.], or to [Preset] with [Rec Run] running mode, the time code running mode will be changed automatically to [Free Run] when pre-recording is activated.
 - When the special recording mode is deactivated, the time code running mode will return to its previous setting.
- You can use only one special recording mode at a time.
- If the system frequency is changed, pre-recording mode will be canceled.

[ Recording/Media Setup]

[Recording Mode]

[Normal Recording]

Frame Recording Mode

Set the number of frames in advance. We recommend operating the camera remotely or stabilizing the camera, for example, on a tripod. Sound is not recorded in this mode.

Activating and Configuring

- 1 Open the [Recording Mode] submenu.
 [📷 Recording/Media Setup] ➤ [Recording Mode]
- 2 Select [Frame Recording] and then press SET.
 - [FRM STBY] appears at the top of the screen (with [FRM] flashing).
- 3 Open the [Recorded Frames] submenu.
 [📷 Recording/Media Setup] ➤ [Special Recording Settings] ➤
 [Frame Recording] ➤ [Recorded Frames]
- 4 Select the desired number of frames and then press SET.
 - Available options are: 1, 3, 6 and 9 frames.

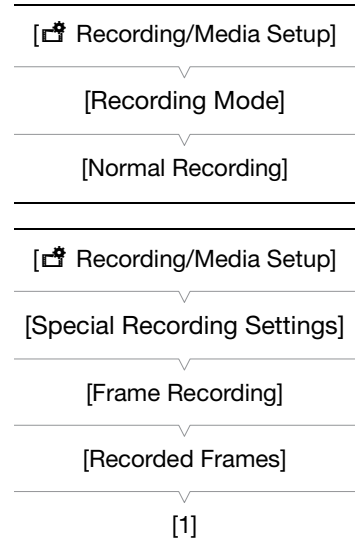

Recording

- 1 Press the START/STOP button to begin recording.
 - The camera automatically records the specified number of frames.
 - The tally lamp illuminates.
 - [FRM STBY] changes to [● FRM REC] while recording frames and [● FRM STBY] when frames are not being recorded.
 - Repeat until you finish recording.
- 2 When you have finished recording, turn off the special recording mode.
 - Repeat steps 1 and 2 of the previous procedure selecting [Normal Recording] instead.
 - Frame recording mode ends and all of the recorded frames are joined together into one clip.
 - The tally lamp goes out and [STBY] appears at the top of the screen.

NOTES

- If Long GOP compression was being used, the bit rate will change automatically to an option with Intra-frame compression.
- You can use only one special recording mode at a time.
- The number of frames recorded cannot be changed while recording.
- Some frames at the point the recording was stopped may be recorded and added to the end of the clip.
- If the system frequency is changed, frame recording mode will be canceled and the [Recorded Frames] setting will be reset to its default value.
- About the time code during frame recording mode:
 - The time code mode can be set to [Regen.], or to [Preset] with [Rec Run] running mode. The time code advances by the number of frames recorded every time.
 - If the time code running mode was set to [Free Run] or the camera was synchronized to an external time code signal, the time code running mode will be changed automatically to [Rec Run] when interval recording is activated.
 - When the special recording mode is deactivated, the time code running mode will return to its previous setting.
 - The time code signal will not be output from the TIME CODE terminal, REC OUT terminal, MON. terminal or HDMI OUT terminal.

Interval Recording Mode

Set the interval and number of frames in advance. Sound is not recorded in this mode.

Activating and Configuring

- 1 Open the [Recording Mode] submenu.
[Recording/Media Setup] ➤ [Recording Mode]
- 2 Select [Interval Recording] and then press SET.
 - [INT STBY] appears at the top of the screen (with [INT] flashing).
- 3 Open the [Interval] submenu.
[Recording/Media Setup] ➤ [Special Recording Settings] ➤ [Interval Recording] ➤ [Interval]
- 4 Select the desired interval and then press SET.
 - You can select one of 12 interval settings from 1 second to 10 minutes.
- 5 To set the number of frames to record, open the [Recorded Frames] submenu.
[Recording/Media Setup] ➤ [Special Recording Settings] ➤ [Interval Recording] ➤ [Recorded Frames]
- 6 Select the desired number of frames and then press SET.
 - Available options are 1, 3, 6 and 9 frames.

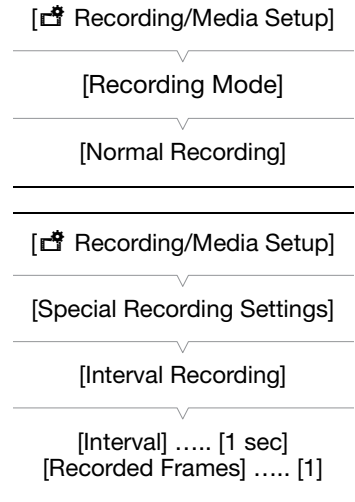

Recording

- 1 Press the START/STOP button to begin recording.
 - The camera automatically records the set number of frames at the specified interval.
 - The tally lamp illuminates.
 - [INT STBY] changes to [● INT REC] while recording frames, and [● INT] and a countdown until the next recording between recordings.
- 2 Press the START/STOP button again to stop recording.
 - All of the recorded frames are joined together into one clip.
 - The tally lamp goes out and [INT STBY] appears at the top of the screen (with [INT] flashing).
- 3 When you have finished recording, turn off the special recording mode.
 - Repeat steps 1 and 2 of the previous procedure selecting [Normal Recording] instead.

NOTES

- If Long GOP compression was being used, the bit rate will change automatically to an option with Intra-frame compression.
- You can use only one special recording mode at a time.
- The interval and the number of frames recorded cannot be changed while recording.
- Some frames at the point the recording was stopped may be recorded and added to the end of the clip.
- If the system frequency is changed, interval recording mode will be canceled and the interval recording settings will be reset to default values.

- About the time code during interval recording mode:
 - The time code mode can be set to [Regen.], or to [Preset] with [Rec Run] running mode. The time code advances by the number of frames recorded every time.
 - If the time code running mode was set to [Free Run] or the camera was synchronized to an external time code signal, the time code running mode will be changed automatically to [Rec Run] when interval recording is activated.
 - When the special recording mode is deactivated, the time code running mode will return to its previous setting.
 - The time code signal will not be output from the TIME CODE terminal, REC OUT terminal, MON. terminal or HDMI OUT terminal.

Using the Optional RC-V100 Remote Controller

You can connect the optional RC-V100 Remote Controller to the camera's REMOTE terminal in order to control the camera (including advanced recording functions) from a distance. The remote controller lets you turn the camera on, navigate the menus and remotely control the aperture and shutter speed, change picture-related settings like the knee and sharpness, and more.

Use the cable supplied with the remote controller to connect it to the camera. For details on how to connect and use the remote controller, refer to its instruction manual.

Operating modes: CAMERA MEDIA

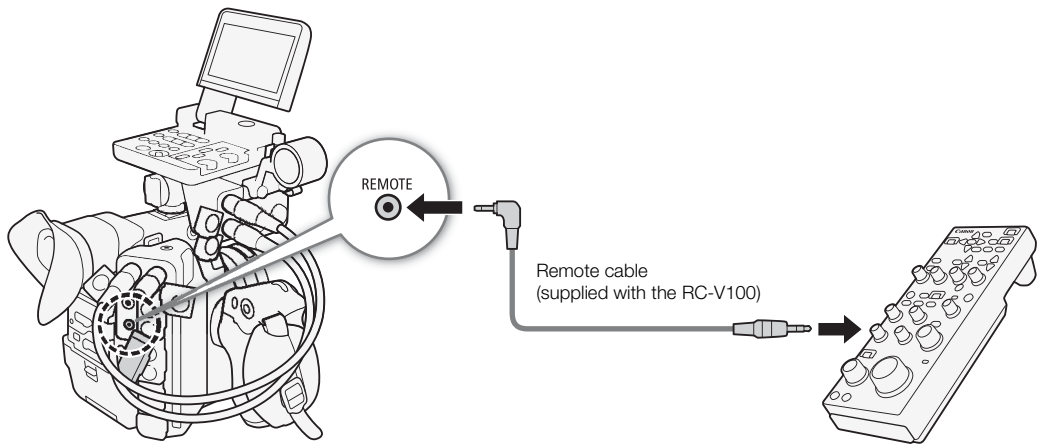

- 1 Turn off the camera and connect the optional RC-V100 Remote Controller to the camera.
- 2 Turn on the camera and open the [REMOTE Term.] submenu.
[System Setup] ➤ [REMOTE Term.]
- 3 Select [RC-V100] and then press SET.

[System Setup]

[REMOTE Term.]

[Standard]

Options

- [RC-V100]: Select this option to use the optional RC-V100 Remote Controller.
 [Standard]: Select this option to use commercially available remote controls.

i NOTES

- The following controls on the remote controller will not operate the camera: AGC button and AUTO KNEE button.
- The AUTO IRIS button on the remote controller will operate the camera only when a compatible EF lens (213) is attached to the camera.
- The ZOOM button on the remote controller will operate the lens only when a CINE-SERVO CN7x17 KAS S/E1 lens is attached to the camera.
- Adjusting picture-related settings with the remote controller can be performed only when the detailed settings were activated ([Custom Picture] ➤ [Other Settings] ➤ [Activate] is set to [On], 134).

Browser Remote: Controlling the Camera via Wi-Fi

You can attach an optional WFT-E6 Wireless File Transmitter to the camera's system extension terminal and operate the camera remotely via Browser Remote, a Web browser application that can be accessed using the Web browser on any device compatible with Wi-Fi networks*. Using Browser Remote, you can check the camera's live view image, control various recording settings, set and change metadata and add marks to the clip. On the Browser Remote screen, you can also check the remaining recording time on the recording media, remaining battery time and the camera's time code.

* For details about compatible devices, operating systems, Web browsers, etc. please visit your local Canon Web site.



Operating modes:

Preparations

To be able to operate the camera remotely via Wi-Fi, you will need to attach an optional WFT-E6 Wireless File Transmitter to the camera's system extension terminal, complete the Wi-Fi network setup, and open Browser Remote on the Web browser of a connected Wi-Fi enabled device. Download the 'WFT-E6: Guide for EOS C300 Mark II Users' (PDF file) from your local Canon Web site and follow the instructions to complete the necessary steps.

Using Browser Remote

The Browser Remote application has 3 screens: [📺] the main screen for controlling the camera remotely in recording mode, [📄] the metadata screen, and [📱] a basic screen that allows users only to start/stop recording using a smartphone or other device with a small screen. The screen displayed will differ depending on the user information used to log in.

The following sections explain how to use the Browser Remote controls. For detailed information and applicable restrictions about the functions themselves, please refer to each function's explanation.

NOTES

- Browser Remote does not support multi-touch gestures.

The Main Remote Recording Screen []

* [Full Control User]/[Camera Control User] only.

When using a computer, tablet and other devices with larger screens, this screen offers all the controls available for operating the camera remotely via Browser Remote.

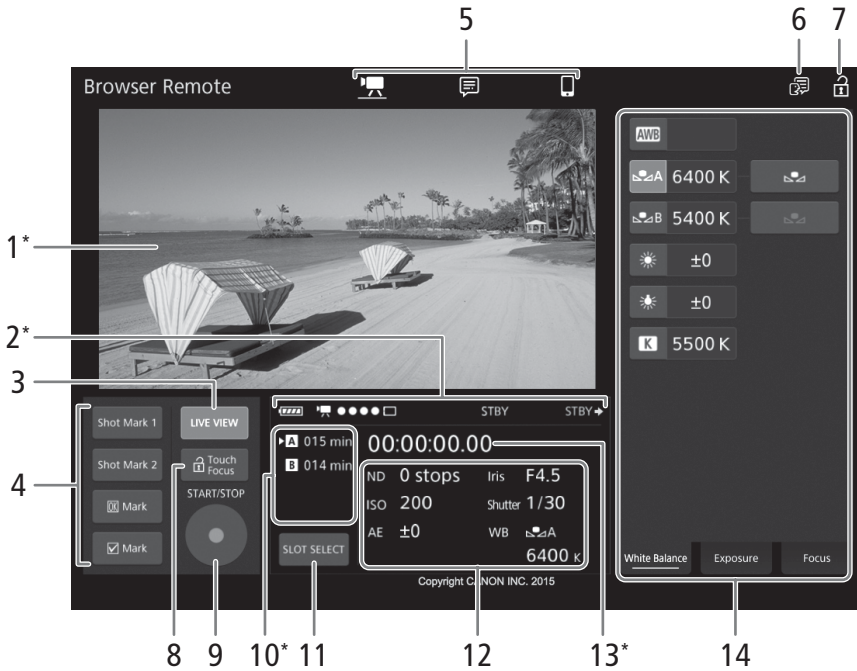

* Onscreen display/indication only. The content or value cannot be changed using Browser Remote.

1 Live view screen

Shows the camera's live view image. When the live view image is not turned on, the camera ID and lens information will appear here.

- The live view image will be turned off automatically while the camera is displaying color bars.

2 Status indicators

- , etc. : Approximate remaining charge of the camera's battery pack.
- : Wi-Fi connection indicator. While Browser Remote is correctly connected to the camera, the will keep turning on and off in a loop.
- : Appears during double slot recording (50).
- STBY, etc. : Recording operation (same as on the camera, 56).
- STBY➡, REC➡ : Output recording command (185).

3 [LIVE VIEW] button

Touch/click the button to display the camera's live view image on the Browser Remote screen.

The Main Remote Recording Screen: Detailed Camera Settings

The following sections explain how to use the controls in the detailed camera settings panel. For detailed information and applicable restrictions about the functions themselves, please refer to each function's explanation.

To change the white balance

Touch/click the [White Balance] tab in the detailed camera settings panel.

1 Auto white balance button

Touch/click [**AWB**] to set the camera to auto white balance (AWB) mode.

2 Custom white balance buttons

Touch/click [**A**] or [**B**]. If a custom white balance has not yet been stored, the icon in the button will flash slowly.

To set the custom white balance: Point the camera at a gray card or white object with no pattern so it fills the whole screen and touch/click [**A**]. Use the same lighting conditions you plan to use when recording.

During the procedure, the icon in the button will flash quickly. When it stops flashing, the procedure is completed and the custom white balance will be applied.

3 Preset white balance buttons

Touch/click [**☀**] (daylight) or [**💡**] (tungsten lamp) to apply the corresponding preset white balance setting.

To fine-tune the preset settings: Touch/click the adjustment value [**±0**] next to the selected button and select the desired adjustment value (−9 to +9) from the list that appears to the right.

4 Color temperature buttons

Touch/click [**K**] to apply the color temperature value shown next to the [**K**] button.

To change the color temperature: Touch/click the color temperature value and select the desired color temperature from the list that appears to the right.

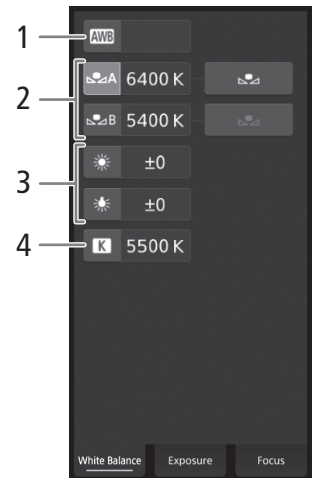

To change exposure related settings

Touch/click the [Exposure] tab in the detailed camera settings panel.

1 ND Filter buttons

- To use the extended ND range options (8 or 10 stops), touch [Extended Range].
- Touch/click [-] or [+] to change the density of the ND filter (displayed above the buttons). You can also touch the current ND filter setting and select the desired setting from a list of options.

2 Aperture related buttons (only when using a compatible lens,  213)

- To let the camera adjust the aperture automatically, touch [Manual] and select [Automatic] instead. No further settings are necessary. To adjust the aperture manually, select [Manual] and use the aperture-related controls as described below.
- To change the adjustment increment, touch [1/3] and select the desired iris increment ([1/2], [1/3] or [Fine]).
- Touch/click [-] or [+] to change the aperture value (displayed above the buttons). You can also touch the current aperture value and select the desired value from a list of options.
- Only when using a Canon Cinema lens: To display the aperture values as T values instead of F values, touch [F] and select [T]. Select [F] to return the display to F values.

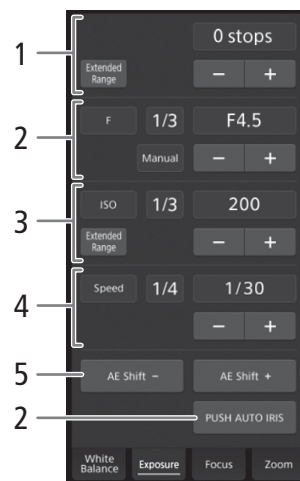

 **NOTES**

- During manual aperture adjustment, you can also touch/click [PUSH AUTO IRIS] to have the camera adjust the aperture automatically once. (The manual aperture buttons will not be available at this time.)

3 ISO speed/Gain related buttons

ISO speeds are displayed by default. To adjust the gain instead, touch [ISO] and select [Gain].

- To use the ISO speeds/gain values in the extended range, touch [Extended Range].
- To change the adjustment increment, touch [1/3] (ISO speed) or [Normal] (gain) and select the desired ISO increment ([1/3] or [1]) or gain increment ([Normal] or [Fine]).
- Touch/click [-] or [+] to change the ISO speed/gain value (displayed above the buttons). You can also touch the current ISO speed/gain value and select the desired value from a list of options.

4 Shutter speed related buttons

- To change the shutter speed mode, touch [Speed] and select the desired shutter speed mode ([Speed] (standard shutter speed), [Angle], [Clear Scan], [Slow] (slow shutter speeds), or [Off]).
- To change the adjustment increment, touch [1/3] and select the desired increment ([1/3] or [1/4]).
- Touch/click [-] or [+] to change the shutter speed (displayed above the buttons). You can also touch the current shutter speed value and select the desired value from a list of options.

5 AE shift buttons

Touch/click [AE Shift -] or [AE Shift +] to change the AE shift level.

To adjust the focus and use focus-related functions

Touch/click the [Focus] tab in the detailed camera settings panel. To use the following functions, make sure that the AF mode switch on the lens is set to AF.

- If the focus mode switch on the EF lens is set to MF, you will not be able to use Browser Remote to control the focus. Depending on the lens used, remote operation may not work correctly.

1 AF mode button

2 AF frame position button

Touch/click the button to select the position of the AF frame. Select [Center] for a fixed AF frame at the center of the live view screen, or [Selectable] to be able to touch/click the live view screen to select where to focus (📖 126).

3 Face AF mode button

Touch/click the button to select how the camera will focus when the Face AF function is activated and no face is detected (📖 84).

4 [AF Speed] button

Touch/click the button to select the adjustment speed of applicable lenses when using autofocus functions (📖 82).

5 [Face Det. & Tracking] button

6 [ONE-SHOT AF] button (📖 125) / [AF Lock] button (📖 126)

7 Tracking buttons

8 Manual focus buttons

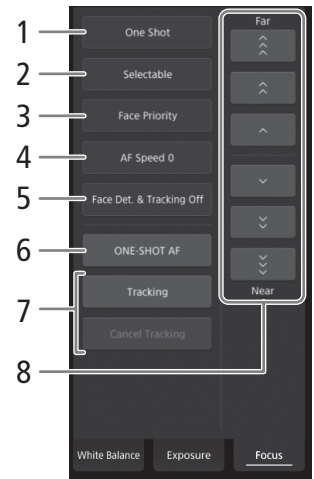

Manual focus

- 1 Touch/click the AF mode button and select [One Shot].
- 2 Touch/click one of the manual focus buttons on the [Near] side to focus closer or one of the controls on the [Far] side to focus farther away. There are three levels of adjustment - [^]/[v] is the smallest and [^]/[v] the largest.

One-shot AF

- 1 Touch/click the AF mode button and select [One Shot].
- 2 Touch click the [ONE-SHOT AF] button.
 - A white AF frame will appear on the live view screen and the camera will focus automatically.
 - When correct focus has been achieved, the AF frame turns green. If the camera cannot focus automatically, the AF frame will turn red.
 - When the AF frame position is set to [Selectable], you can touch/click the live view screen to select where to focus (📖 126).

AF-Boosted MF

- 1 Touch/click the AF mode button and select [AF-Boosted MF].
 - When the focus is in the manual adjustment range, a yellow focus frame will appear on the live view screen.
 - When the AF frame position is set to [Selectable], you can touch/click the live view screen to select where to focus (📖 126).
- 2 Touch/click one of the manual focus buttons to focus closer ([Near] side) or farther ([Far] side) as necessary.
 - When the focus enters the automatic adjustment range, the focus frame will turn white and the camera will then finish focusing automatically.

Continuous AF

- 1 Touch/click the AF mode button and select [Continuous].
 - A white AF frame will appear on the live view screen and the camera will focus automatically.
 - When the AF frame position is set to [Selectable], you can touch/click the live view screen to select where to focus (📖 126).
 - During continuous AF mode, the [ONE-SHOT AF] button will change to [AF Lock]. Touch/click the [AF Lock] button to lock the focus at its current position and frame the picture as necessary. Touch/click the button again to release the AF lock.

Touching the screen to focus on a subject

You can touch on a subject that appears in the Browser Remote's live view screen in order to select it for focusing.

- 1 Touch/click the AF frame position button and select [Selectable].
- 2 Make sure the touch focus function has been unlocked and the 🔒 icon appears in the button (📖 122).
- 3 Touch the desired subject in the live view screen.
 - Depending on the focus mode used, a frame may appear on the selected subject and the camera may also focus on the subject automatically and even start tracking the subject.

Face AF

When the face detection function is activated, the camera will detect people's faces and track the main subject even when it moves. You can use face detection with one of the autofocus functions to let the camera focus on the main subject automatically (Face AF).

- 1 Touch/click [Face Det. & Tracking] and select [On].
- 2 If necessary, touch the Face AF mode button and select [Face Only] or [Face Priority].
 - A face detection frame will appear on the live view screen around all detected faces. The main subject is indicated with arrows (◀▶) on the sides. The camera will track the main subject as it moves.
 - Touch/click on the face of a different subject to select it as the main subject.
 - During continuous AF, the camera will keep focusing on the main subject's face. During one-shot AF, the camera will focus on the main subject's face when you touch/click [ONE-SHOT AF].

Tracking other subjects

In addition to Face AF, you can have the camera track other moving subjects that are not faces and also combine the tracking function with one of the autofocus functions to let the camera focus on the desired subject automatically.

- 1 Touch/click [Face Det. & Tracking] and select [On].
- 2 Touch/click [Tracking].
- 3 Touch/click the live view screen to select the subject you wish to track.
 - A tracking frame will appear on the live view screen and the camera will track the subject as it moves.
 - During continuous AF, the camera will keep focusing on the selected subject. During one-shot AF, the camera will focus on the selected subject when you touch/click [ONE-SHOT AF].
 - Touch/click [Cancel Tracking] to select a different subject, or touch/click [Tracking] again to end the tracking function.

NOTES

- The Dual Pixel Focus Guide function (📖 79) cannot be used from the Browser Remote application.

To adjust the zoom

The zoom can be adjusted only when a CINE-SERVO CN7x17 KAS S/E1 lens is attached to the camera. Touch/click the [Zoom] tab in the detailed camera settings panel.

NOTES

- Depending on when you purchased the lens, to be able to control a CINE-SERVO CN7x17 KAS S/E1 lens using Browser Remote you may need to update the lens's firmware. For details, consult a Canon Service Center.

1 Zoom slider

Drag the zoom slider up/down to zoom in [T] or out [W], respectively.

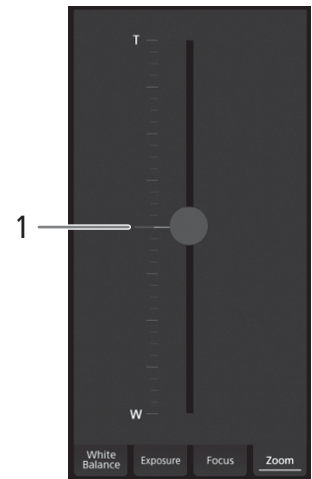

The Basic Screen

* [Full Control User] only.

When using a smartphone or other device with a smaller screen, this screen offers only a small live image screen for final confirmation and the [START/STOP] button to start and stop recording.

To open the basic screen, touch the  icon at the top of the Browser Remote screen.

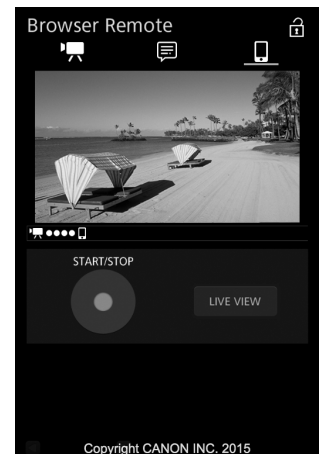

The Metadata Screen [☰]

* [Full Control User]/[Meta Control User] only.

Using Browser Remote you can create, edit and transfer to the camera a metadata profile that can be embedded with the recorded clips. This metadata profile includes the user memo information (clip title, creator, location and description), as well as GPS information. For details, refer to *Using Metadata* (📖 106).

To open the metadata screen, touch the [☰] icon at the top of the Browser Remote screen.



1 Clip title

Touch/click inside the text box and enter the desired text. To delete the text, touch/click [Clear All].

2 GPS information

To enter the altitude: Touch/click inside the [Altitude] text box and enter the desired value.

To enter the latitude: Touch/click inside one of the text boxes and enter (from left to right) the degrees, minutes and seconds values. To select a southern latitude, touch [North] and select [South] instead.

To enter the longitude: Touch/click inside one of the text boxes and enter (from left to right) the degrees, minutes and seconds values. To select a western longitude, touch [East] and select [West] instead.

- Touch/click [Clear All] to delete all the GPS-related fields at once.

3 Live view screen

Shows the camera's live view image. When the live view image is not turned on, the camera ID and lens information will appear here.

- The live view image will be turned off automatically while the camera is displaying color bars.

4 [LIVE VIEW] button

Touch/click the button to display the camera's live view image on the Browser Remote screen.

5 Clip's creator

6 Recording location

7 Description of the clip

Touch/click inside the text box and enter the desired text. To delete the text, touch/click [Clear All].

8 Status indicators

See the descriptions in the section about the [📷] screen (📖 121).

9 [⏏️] [Activate] button

Touch/click the button to give priority to the metadata entered in this screen when recording clips. This overrides the metadata read from a file saved on the SD card.

10 [Overwrite Previous] button/[Overwrite] button

While recording: Touch/click [Overwrite] to send the metadata entered in this screen to the camera, replacing any metadata that the clip being recorded might have.

After recording a clip: Touch/click [Overwrite Previous] to send the metadata entered in this screen to the camera, replacing any metadata embedded in the last clip recorded.

11 [Apply from Next] button

Touch/click the button to send the metadata entered in this screen to the camera so it is embedded only with clips that are recorded after the transfer. This option does not overwrite the metadata of clips already recorded or being recorded.

📘 NOTES

- The metadata sent to the camera from Browser Remote will be lost in the following cases.
 - If the camera was turned off.
 - If the [📷 Recording/Media Setup] ➡ [Metadata] ➡ [Setting] setting was changed.
- Using Browser Remote ([⏏️] [Activate] button), you can give priority to metadata sent from the application. However, you cannot return the priority back to the SD card. To use a user memo file saved on the SD card you will need to set [📷 Recording/Media Setup] ➡ [Metadata] ➡ [Setting] to [SD Card] on the camera itself.
- Metadata sent to the camera from Browser Remote will not be added to relay clips recorded before the switch to the current CFast card.

Assignable Buttons

The camera offers a number of buttons to which you can assign various functions (assignable buttons). Assign often-used functions to the buttons you find most convenient, to personalize the camera to your needs and preferences.

You can find 11 assignable buttons on the camera's body, 10 assignable buttons on the monitor unit* and one assignable button on the grip unit. The optional RC-V100 Remote Controller offers 4 additional assignable buttons that can be used when it is connected to the camera. In most cases, the names of the buttons printed on the camera and modular units also indicate their default settings.

* In **MEDIA** mode, only assignable buttons 7 to 10 are available.

Operating modes: **CAMERA** **MEDIA**

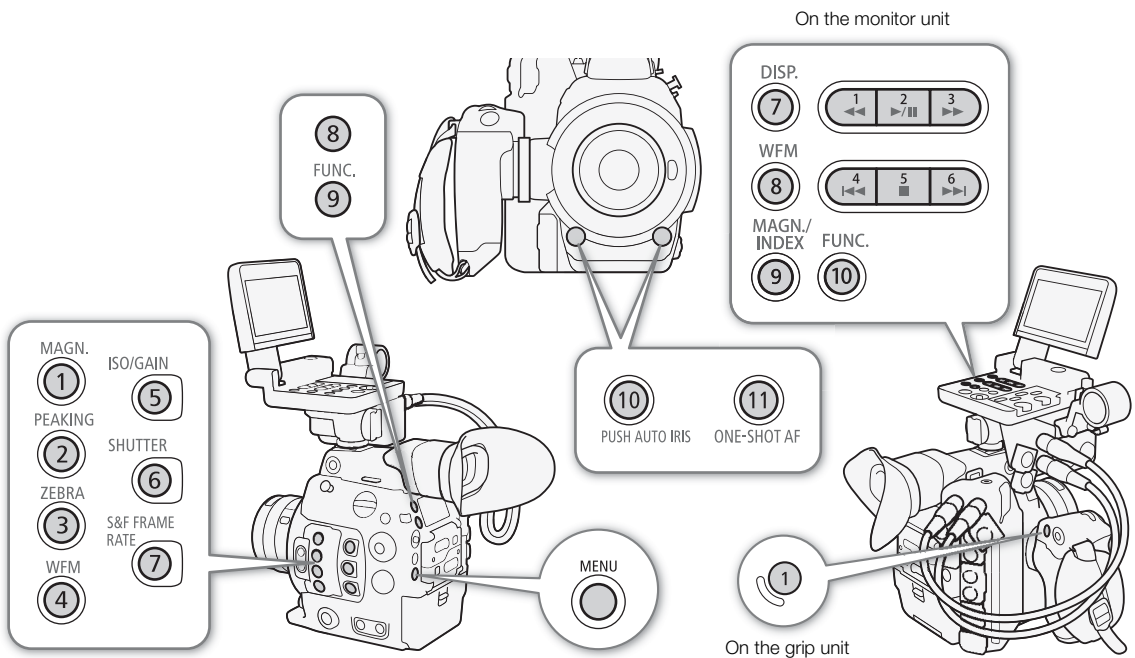

Changing the Assigned Function

1 Press the MENU button and, while holding it pressed down, press the assignable button whose function you wish to change.

- A list of available functions appears with the current function assigned to the button highlighted.
- You can also open the submenu corresponding to the button whose function you wish to change under [System Setup] ➤ [Assignable Buttons] ➤ [Camera], [Grip], [Monitor] or [Remote Controller].

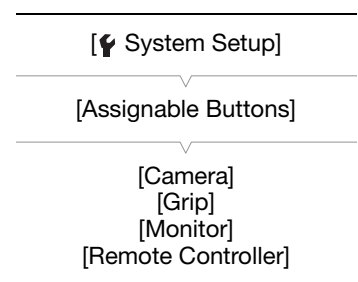





2 Select the desired function and then press SET.

- The selected function will be assigned to the selected button.
- If you selected one of the preset functions, the rest of the procedure is not necessary. If you selected [User Setting], the menu's title bar will change to blue to indicate you are selecting a menu setting to register. Continue the procedure to register a menu setting.

3 Navigate the menus to find the menu setting you want to register and then press SET.

- The selected menu setting will be assigned to the selected button. User-selected settings will be indicated with a ★ in the assignable buttons' submenu.

NOTES



- You can check the three [Assignable Buttons] status screens ( 194) to see what functions are currently assigned to each button.
- You can reset only the functions assigned to the assignable buttons, without affecting other camera settings, with the [ System Setup]  [Reset]  [Assignable Buttons] function. All the assignable buttons will return to their default function.









Using an Assignable Button

After you assign a function to one of the buttons, press the button to activate the function. For some functions, an options menu may appear. In such case, select the desired option and then press SET.

Assignable Functions

Functions can be set separately in  mode and  mode. Refer to the following table for assignable functions and available modes.

Function name	Description			
[One-Shot AF]*	The camera focuses automatically one time only (one-shot AF function).	●	–	80
[AF Lock]	Locks the focus during continuous AF.	●	–	83
[Focus Guide]	Turns the Dual Pixel Focus Guide function on/off.	●	–	79
[Face AF]	Toggles the [Face AF] setting between [Face Priority] and [Face Only]	●	–	84
[Face Det. & Tracking]	Turns the face detection function on/off.	●	–	84
[Tracking]	Turns the tracking function on/off.	●	–	84
[Push Auto Iris]	The camera automatically adjusts the aperture only while the button is held pressed down.	●	–	71
[Iris Mode]	Switches the aperture adjustment mode between automatic and manual.	●	–	70
[Iris +]	Opens up the aperture.	●	–	71
[Iris –]	Closes the aperture.	●	–	
[ND +]	Cycles through ND filter settings in increasing (higher density) order.	●	–	69
[ND –]	Cycles through ND filter settings in decreasing (lower density) order.	●	–	
[AE Shift +]	Compensates the exposure making the image brighter.	●	–	72
[AE Shift –]	Compensates the exposure making the image darker.	●	–	
[Backlight]	Turns the [Backlight] light metering option on/off.	●	–	73
[Spotlight]	Turns the [Spotlight] light metering option on/off.	●	–	
[FUNC.]	Enters the direct setting mode, replicating the function of the camera's FUNC. button.	●	–	64
[Shutter]	Enters the direct setting mode with the shutter speed highlighted and ready to be adjusted.	●	–	66
[ISO/Gain]	Enters the direct setting mode with the ISO speed or gain value highlighted and ready to be adjusted.	●	–	67

Function name	Description	CAMERA	MEDIA	
[White Balance]	Enters the direct setting mode with the white balance highlighted and ready to be adjusted.	●	–	74
[Peaking]	Turns peaking on/off.	●	–	79
[Zebra]	Turns zebra patterns on/off.	●	–	87
[WFM]	Turns the waveform monitor on/off.	●	●	103
[Magnification]	Turns magnification on/off.	●	–	79
[Color Bars]	Turns color bars on/off.	●	–	102
[Markers]	Turns onscreen markers on/off.	●	–	86
[LCD Setup]	Opens the [LCD Setup] submenu.	●	●	41
[Viewfinder Setup]	Opens the [Viewfinder Setup] submenu.	●	●	
[LUT]	Turns on/off the application of the selected LUT to the selected screens/video outputs.	●	–	167
[OSD Output]	Turns on/off the inclusion of onscreen displays on the selected screens/video outputs.	●	●	168
[Display]	Changes the onscreen display level.	●	●	58
[Add Shot Mark 1]*	Adds an  mark to the clip.	●	●	105
[Add Shot Mark 2]*	Adds an  mark to the clip.	●	●	
[Add  Mark]	Adds an  mark to the clip.	●	●	154
[Add  Mark]	Adds a  mark to the clip.	●	●	
[Time Code]	Displays the [Time Code] submenu.	●	–	88
[Time Code Hold]*	Puts the time code display on hold or resumes it.	●	●	89
[Headphones +]	Increases the headphone volume.	●	●	151
[Headphones –]	Reduces the headphone volume.	●	●	
[Monitor Channels]	Switches the audio output channel.	●	●	169
[Audio Level]	Turns the audio level meter on/off.	●	●	99, 100
[Photo]*	Records a photo.	●	●	175
[Review Recording]*	Plays back the last clip recorded in  mode.	●	–	110
[S&F Frame Rate]	Changes the shooting frame rate during slow & fast motion recording mode.	●	–	113
[Status]*	Displays the status screens.	●	●	191
[Custom Picture]	Opens the [ Custom Picture] submenu.	●	–	134
[My Menu]	Opens the [My Menu] customized submenu.	●	–	33
[Initialize Media]	Opens the [Initialize Media] submenu.	●	●	49
[Index]	From the clip index screen: Opens the index screen selection menu. From other index screens: Returns to the clip index screen.	–	●	148
[★ User Setting]*	Customizable slot. Assign to the button any menu setting you would like to register.	●	●	–

* Function can be used only by assigning it to a button.

Custom Picture Settings

The camera lets you change many settings (📖 138) that control various aspects of the image produced. As a set, all these settings are treated as a single custom picture file. After adjusting the desired settings to your preference, you can save up to 20 custom picture files (in the camera or on an SD card), and load them later to apply exactly the same settings (📖 137). You can also save the custom picture file as part of the metadata embedded in clips recorded on the CFast card (📖 137).

i NOTES

- Custom picture files are exclusively compatible for use only with C300 Mark II cameras.

Operating modes: CAMERA MEDIA

Selecting Custom Picture Files

Select a custom picture file to apply its settings to your recordings or to edit, rename, protect, or transfer it.

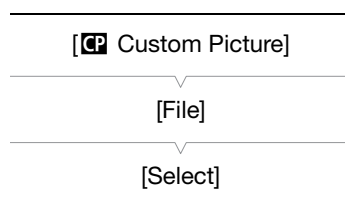

1 Open the custom picture file's [Select] screen.

[CP Custom Picture] ➤ [File] ➤ [Select]

- When an optional RC-V100 Remote Controller is connected to the camera, you can press the remote controller's CUSTOM PICT. button to open the [CP Custom Picture] submenu.

2 Push the joystick up/down or turn the SELECT dial to select the desired file and then press SET.

- Select one of the custom picture files saved in the camera (C1 to C20). To use the settings of a custom picture file saved on an SD card, copy the file to the camera in advance (📖 137).
- When you close the menu, the selected custom picture file's settings will be applied.
- If you selected a preset picture setting, its icon will appear on the left of the screen. If the detailed settings were activated ([CP Custom Picture] ➤ [Other Settings] ➤ [Activate] is set to [On]), will appear on the left of the screen.

Preset Picture Settings

The camera offers the following preset picture settings (combinations of gamma curve, color space and color matrix). When you edit a custom picture file to your preference, you can use one of the presets or turn the presets off and change the desired settings individually (📖 138).

[Preset]*	[CP Custom Picture] ➤ [Main Settings] settings			Characteristics
	[Gamma]	[Color Space]	[Color Matrix]	
[Canon Log 2: C.Gamut]	[Canon Log 2]	[Cinema Gamut]	[Neutral]	These settings use Canon Log 2 gamma and presume a workflow that includes post-production processing. They achieve an even wider dynamic range than with the [Canon Log] setting and superior gradation in the shadows (dark areas of the image). The color space can be selected from 4 options.
[Canon Log 2: BT.2020]		[BT.2020 Gamut]		
[Canon Log 2: DCI-P3]		[DCI-P3 Gamut]		
[Canon Log 2: BT.709]		[BT.709 Gamut]		

[Preset]*	[CP Custom Picture] ➤ [Main Settings] settings			Characteristics
	[Gamma]	[Color Space]	[Color Matrix]	
[Canon Log]**	[Canon Log]	[BT.709 Gamut]	[Cinema EOS Original]	This setting uses Canon Log gamma and presumes a workflow that includes post-production processing. It can obtain an impressive dynamic range and color tones appropriate for post-production.
[BT.2020]**	[Wide DR]	[BT.2020 Gamut]	[Neutral]	These settings produce the widest dynamic range possible without requiring post-production. The color space can be selected from 2 options.
[BT.709]**	[Wide DR]	[BT.709 Gamut]	[Neutral]	

* [CP Custom Picture] ➤ [Preset].

**Only when [CAMERA Recording/Media Setup] ➤ [REC OUT 4K RAW Mode] is set to a setting other than [4K RAW].

i NOTES

• **About the logarithmic gamma curves Canon Log/Canon Log 2**

These gamma curves assume the need for post-production processing. They were designed to make the most of the imaging sensor characteristics in order to obtain impressive levels of dynamic range.

- In [CAMERA] mode, you can apply a LUT to the LCD screen and viewfinder and to video output from the REC OUT terminal or the MON. and HDMI OUT terminals to use gamma curve/color space settings more suitable for viewing on a monitor screen.
- There are also other LUTs available that can be applied for processing in post-production. For the latest information on available LUTs, please visit your local Canon Web site.

• **About changing custom picture related settings using the optional RC-V100 Remote Controller**

- If a protected custom picture file is selected on the camera, custom picture related settings cannot be changed using the remote controller.
- Adjusting custom picture related settings using the remote controller will change the settings registered under the currently selected custom picture file. If you want to keep an important custom picture file, copy it in advance to an SD card or select in advance a custom picture file you do not mind changing.

Editing a Custom Picture File's Settings

- 1 Select a custom picture file (📖 134).
- 2 Open the [Preset] submenu.
[CP Custom Picture] ➤ [Preset]
- 3 Select the desired option and then press SET.
 - To use preset picture settings: Select the desired preset setting (📖 134) and skip to step 6.
 - To select the main settings individually: Select [Off] and continue to step 4.
- 4 Open the [Main Settings] submenu.
[CP Custom Picture] ➤ [Main Settings]
- 5 Select [Gamma], select the desired gamma curve and then press SET.
 - Select [Color Space] to select the color space, and/or [Color Matrix] to select the color matrix in the same way.
- 6 To change the other detailed settings, open the [Other Settings] submenu.
[CP Custom Picture] ➤ [Other Settings]
- 7 Select [Activate], select [On] and then press SET to activate the custom picture file's other settings.

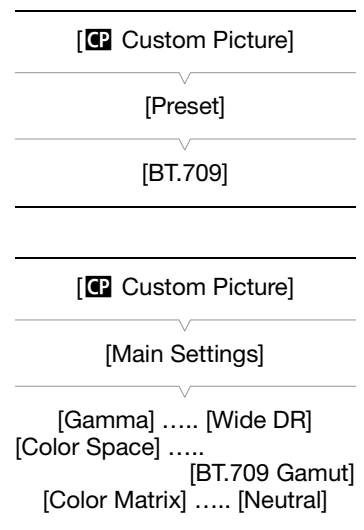

8 Select a setting and then press SET.

9 Change the setting to the desired level and then press SET.

- Refer to *Available Custom Picture Settings* (📖 138) for details on the various settings.
- Repeat steps 8 and 9 for other settings, as necessary.
- When you close the menu, the new custom picture settings will be applied.

Resetting Custom Picture Files

1 Select a custom picture file (📖 134).

2 Open the [Reset] submenu.

[CP Custom Picture] ➤ [File] ➤ [Reset]

3 Select [OK] and then press SET.

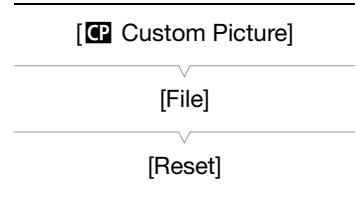

Renaming Custom Picture Files

1 Select a custom picture file (📖 134).

2 Open the [Rename] submenu.

[CP Custom Picture] ➤ [File] ➤ [Rename]

3 To change the file name, select [Input] and then press SET.

- Enter the desired file name (up to 8 characters) using the keyboard screen (📖 35).

4 Select [OK] and then press SET.

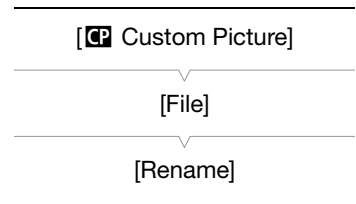

Protecting Custom Picture Files

Protecting a custom picture file prevents its settings from being accidentally changed.

1 Select a custom picture file (📖 134).

2 Open the [Protect] submenu.

[CP Custom Picture] ➤ [File] ➤ [Protect]

3 Select [Protect] and then press SET.

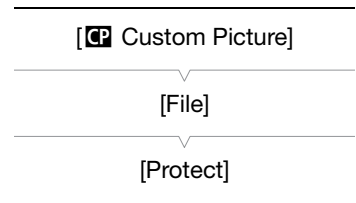

- In the custom picture file selection screen,  will appear next to the file name.
- To remove protection settings, select [Unprotect] instead.



Copying Custom Picture Files

You can transfer custom picture files between the camera and SD card.

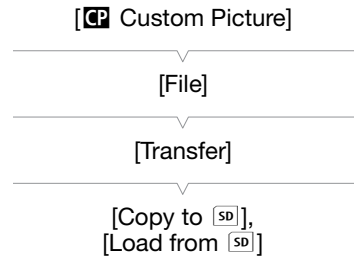

Copying a File from the Camera to an SD Card

- 1 Select a custom picture file (📖 134).
- 2 Open the [Copy to ] submenu.
[CP Custom Picture] ➤ [File] ➤ [Transfer] ➤ [Copy to ]
- 3 Select the destination file and then press SET.
 - Select an existing custom picture file to overwrite it or, if this option is available, select [New File] to save the settings as a new custom picture file on the SD card.
- 4 Select [OK] and then press SET.
 - The file on the SD card will be overwritten or a new file will be created on the SD card.
- 5 When the confirmation message appears, press SET.



137

Replacing a File in the Camera with a File on an SD Card



- 1 Select the custom picture file that you wish to replace (📖 134).
- 2 Open the [Load from ] submenu.
[CP Custom Picture] ➤ [File] ➤ [Transfer] ➤ [Load from ]
- 3 Select the file with the settings that you want to replicate and then press SET.
- 4 Select [OK] and then press SET.
 - The file in the camera will be overwritten by the one on the SD card.
- 5 When the confirmation message appears, press SET.

NOTES

- You can also copy to the camera a custom picture file embedded in a clip (📖 157).

Embedding Custom Picture Settings in a Clip

When you record a clip using custom picture settings, you can have the custom picture file embedded in the metadata and saved along with the clip. Later, you can copy the custom picture file embedded in the clip to the camera (📖 157) and use the same custom picture settings to record additional clips.

- 1 Open the [Add  File] submenu.
[🔧 Recording/Media Setup] ➤ [Metadata] ➤ [Add  File]
- 2 Select [On] or [Off] and then press SET.

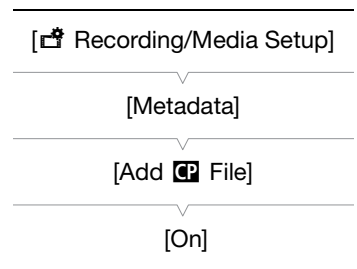

Available Custom Picture Settings

Preset and Main Picture Settings

[Preset]

The camera offers a number of preset picture settings (combinations of color space, gamma curve and color matrix). For details, refer to *Preset Picture Settings* (📖 134). (Default: [BT.709])

[Off]: Select this setting when you want to set a different combination of custom picture settings with the individual [📷 Custom Picture] ➡ [Main Settings] settings described below.

[Main Settings] ➡ [Gamma]

The gamma curve changes the overall look of the image. (Default: [Wide DR])

[Canon Log 2]: Logarithmic gamma curve that obtains an even wider dynamic range than with the [Canon Log] option. Requires image processing in post-production.

[Canon Log]*: Logarithmic gamma curve that obtains an impressive dynamic range. Requires image processing in post-production.

[Wide DR]*: Gamma curve with a very wide dynamic range. Optimized for playback on TV monitors.

[EOS Standard]*: This gamma curve approximates the look of an EOS digital SLR camera when the picture style is set to [Standard] 📷. Produces higher contrast than with the [Normal 1 (Standard)] setting.

[Normal 1 (Standard)*]: Standard picture for playback on TV monitors.

[Normal 2 (x4.0)*]: Setting suitable for playback on TV monitors. Produces brighter highlights (bright areas of the image) than with the [Normal 1 (Standard)] setting.

[Normal 3 (BT.709)*]: Setting suitable for playback on TV monitors. Produces a more faithful black gradation in the shadows (dark areas of the image) than with the [Normal 2 (x4.0)] setting.

[Normal 4 (x5.0)*]: Setting suitable for playback on TV monitors. Produces even better black gradation in the shadows (dark areas of the image) than with the [Normal 3 (BT.709)] setting.

* Only when [📷 Recording/Media Setup] ➡ [REC OUT 4K RAW Mode] is set to a setting other than [4K RAW].

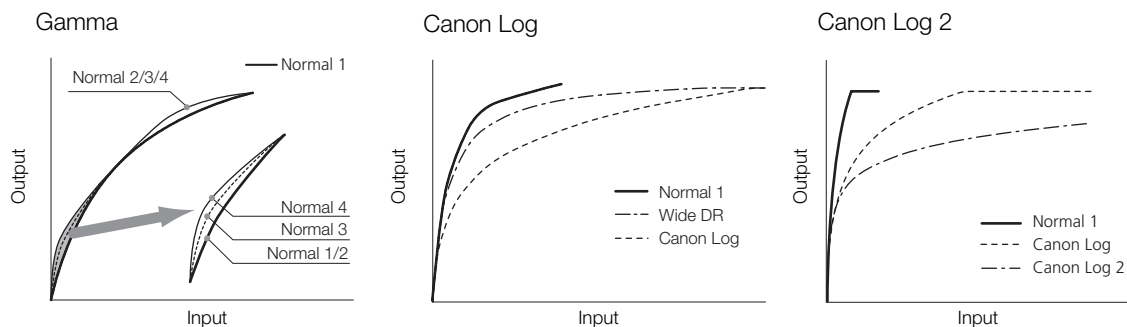

[Main Settings] ➡ [Color Space]

Determines the color space of the image. (Default: [BT.709 Gamut])

[Cinema Gamut]: Color space developed by Canon based on the specific characteristics of the camera's imaging sensor. It covers a wider color gamut than that of BT.2020. Use this setting with workflows that require ACES color space.

[BT. 2020 Gamut]: Color space that meets ITU-R BT.2020 standards, which defines parameters for ultra-high-definition television (4K/8K).

[DCI-P3 Gamut]: Color space that meets the guidelines established by DCI (Digital Cinema Initiatives).

[BT. 709 Gamut]: Standard color space that is compatible with sRGB specifications.

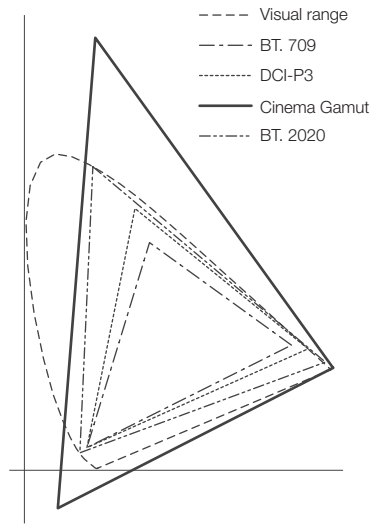

[Main Settings] ➤ [Color Matrix]

The color matrix affects the overall color tonality of the image. (Default: [Neutral])

[Neutral]: Reproduces neutral colors.

[Production Camera]: Reproduces colors more suitable for motion picture production.

[Cinema EOS Original]: Color matrix developed by Canon, designed to reproduce the 4K output of an EOS C500 camera using the BT.709 color space.

[Video]: Reproduces the colors of an EOS C300/EOS C500 camera with no custom picture settings applied.

[EOS Standard]: Approximates the look of an EOS digital SLR camera when the picture style is set to [Standard] .

[Off]: Colors are not adjusted.

Other Settings

[Other Settings] ➤ [Activate]

Set this setting to [On] to apply any changes made to the detailed custom picture settings under the [Other Settings] submenu, as described in this section. (Default: [Off])

[Other Settings] ➤ [Black] ➤ [Master Pedestal]

The master pedestal increases or decreases the black level. Higher settings will make dark areas brighter but decrease contrast. This setting can be adjusted from -50 to 50. (Default: ±0)

[Other Settings] ➤ [Black] ➤ [Master Black Red], [Master Black Green], [Master Black Blue]

These settings correct the color cast in blacks. Each can be adjusted from -50 to +50. (Default: ±0)

[Other Settings] ➤ [Black Gamma]

Controls the lower part of the gamma curve (dark areas of the image). When [Gamma] is set to [Canon Log 2], [Canon Log] or [Wide DR], this setting has no effect on the picture.

[Level]: Raises or lowers the lower part of the gamma curve. This setting can be adjusted from -50 to 50. (Default: ±0)

[Range]: Selects the adjustment range from the selected [Point]. This setting can be adjusted from -20 to 50. (Default: ±0)

[Point]: Determines the shape of the lower part of the gamma curve. This setting can be adjusted from -20 to 50. (Default: ±0)

Black Gamma

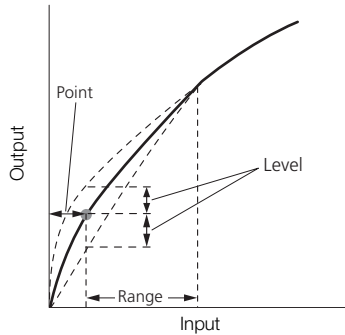

[Other Settings] ▶ [Low Key Satur.]

Adjusts color saturation in dark areas.

[Activate]: Activates/deactivates the setting. (Default: [Off])

[Level]: Specifies how saturated colors are in dark areas. This setting can be adjusted from -50 to 50. (Default: ±0)

[Other Settings] ▶ [Knee]

Controls the upper part of the gamma curve (highlights of the image). By compressing the highlights, you can prevent parts of the image from being overexposed. When [Gamma] is set to [Canon Log 2], [Canon Log], [Wide DR] or [EOS Standard], this setting has no effect on the picture.

[Activate]: Activates/deactivates the setting. (Default: [On])

[Slope]: Determines the slope of the gamma curve above the knee point. This setting can be adjusted from -35 to 50. (Default: ±0)

[Point]: Sets the knee point of the gamma curve. This setting can be adjusted from 50 to 109. (Default: 95)

[Saturation]: Adjusts color saturation in highlights. This setting can be adjusted from -10 to 10. (Default: ±0)

Slope

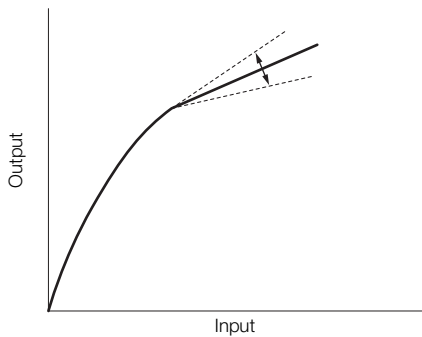

Point

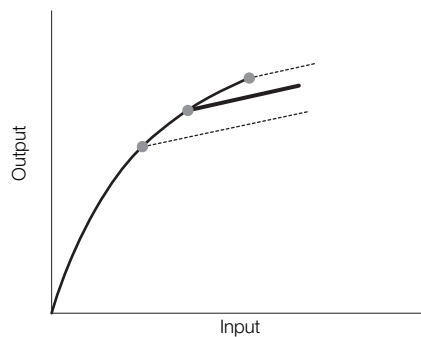

[Other Settings] ▶ [Sharpness]

Sets the sharpness of the output and recording signal.

[Level]: Sets the sharpness level. This setting can be adjusted from -10 to 50. (Default: ±0)

[H Detail Freq.]: Sets the center frequency of horizontal sharpness. Setting higher values increases the frequency, which, in turn, increases the sharpness. This setting can be adjusted from -8 to 8. (Default: ±0)

- [Coring Level]: Sets the level of correction of artifacts caused by high sharpness levels (coring). Higher values prevent sharpness from being applied to minute details, resulting in less noise. This setting can be adjusted from -30 to 50. (Default: ± 0)
- [Coring D-Ofst]: Sets the coring level of the minimum brightness level (level-dependent offset). This setting can be adjusted from 0 to 50. (Default: 0)
- [Coring D-Curve]: Sets the curve of coring adjustment, in other words, how the coring level changes from the value set for [Coring Level] to that set for [Coring D-Ofst] (level-dependent curve). This setting can be adjusted from 0 to 8. (Default: 0)
- [HV Detail Bal.]: Adjusts the ratio between horizontal and vertical detail. Higher values emphasize vertical detail while lower values emphasize horizontal detail. This setting can be adjusted from -8 to 8. (Default: ± 0)
- [Limit]: Restricts how much sharpness is applied. This setting can be adjusted from -50 to 50. (Default: ± 0)
- [Select]: In addition to the sharpness set by [Level], [Select] sets the sharpness for areas with higher frequencies. Higher values apply more sharpness to areas with higher frequencies. Use this for subjects in which normal sharpening is not effective. This setting can be adjusted from 0 to 15. (Default: 0)
- [Knee Aperture Gain], [Knee Aperture Slope]: These settings allow you to adjust the sharpness of only the areas above the knee point. When [Gamma] is set to [Canon Log 2], [Canon Log], [Wide DR] or [EOS Standard], these settings have no effect on the picture.
- [Knee Aperture Gain]: Sets the amount of sharpness. This setting can be adjusted from 0 to 9. (Default: 0)
- [Knee Aperture Slope]: Sets the slope of the sharpness. This setting can be adjusted from 0 to 3, with 0 having no slope, 1 having a steep slope and 3 having a gradual slope. (Default: 1)
- [Level Depend Level]: Sets the brightness of the dark areas of the image that will be affected. This setting can be adjusted from 0 to 50. (Default: 0)
- [Level Depend Slope]: Determines the slope of the area between the upper and lower parts of the gamma curve. This setting can be adjusted from 0 to 3, with 0 having no slope, 1 having a steep slope and 3 having a gradual slope. (Default: 0)
- [Level Depend Offset]: Adjusts the sharpness level of dark areas in the image. Setting higher values will lower the sharpness level. This setting can be adjusted from 0 to 50. (Default: 0)

[Other Settings] ➤ [Noise Reduction]

Reduces the amount of noise that appears in the image. Select a level from 1 (lowest level) to 12 (highest level), or select [Off] to turn the noise reduction off. (Default: [Off])

[Other Settings] ➤ [Skin Detail]

The camera applies a softening filter to areas in the picture with skin tones to give a more pleasant appearance. By changing these settings, you can determine what areas will be detected as skin tones. A zebra pattern will appear on the LCD screen or a monitor connected to the MON. terminal over areas of the image that are detected as having skin tones.

[Effect Level]: Adjusts the level of the filter. The available options are [Off], [Low], [Middle] and [High]. (Default: [Off])

[Hue]: Adjusts the hue for detection of skin tones. This setting can be adjusted from -16 to 16. (Default: ± 0)

[Chroma]: Adjusts the color saturation for detection of skin tones. This setting can be adjusted from 0 to 31. (Default: 16)

[Area]: Adjusts the color range for detection of skin tones. This setting can be adjusted from 0 to 31. (Default: 16)

[Y Level]: Adjusts the brightness for detection of skin tones. This setting can be adjusted from 0 to 31. (Default: 16)

[Other Settings] ▶ [Selective NR]

The camera detects the characteristics of a certain color or tone and applies a noise reduction filter to the targeted areas. A zebra pattern will appear over targeted areas on the LCD screen or a monitor connected to the MON. terminal.

- [Effect Level]: Adjusts the level of the noise reduction filter. The available options are [Off], [Low], [Middle] and [High]. (Default: [Off])
- [Hue]: Adjusts the hue for the color to be detected. This setting can be adjusted from 0 to 31. (Default: 0)
- [Chroma]: Adjusts the color saturation for the color to be detected. This setting can be adjusted from 0 to 31. (Default: 16)
- [Area]: Adjusts the color range for the color to be detected. This setting can be adjusted from 0 to 31. (Default: 16)
- [Y Level]: Adjusts the brightness for the color to be detected. This setting can be adjusted from 0 to 31. (Default: 16)

[Other Settings] ▶ [Color Matrix Tuning]

Adjust in detail various aspects of the color matrix to affect the color tones of the whole image.

- [Gain]: Adjusts the color intensity. This setting can be adjusted from -50 to 50. (Default: ±0)
- [Phase]: Adjusts the color phase. This setting can be adjusted from -18 to 18. (Default: ±0)
- [R-G]: The R-G matrix changes the tint of the picture along the cyan/green and red/magenta gradations. This setting can be adjusted from -50 to 50. (Default: ±0)
- [R-B]: The R-B matrix changes the tint of the picture along the cyan/blue and red/yellow gradations. This setting can be adjusted from -50 to 50. (Default: ±0)
- [G-R]: The G-R matrix changes the tint of the picture along the magenta/red and green/cyan gradations. This setting can be adjusted from -50 to 50. (Default: ±0)
- [G-B]: The G-B matrix changes the tint of the picture along the magenta/blue and green/yellow gradations. This setting can be adjusted from -50 to 50. (Default: ±0)
- [B-R]: The B-R matrix changes the tint of the picture along the yellow/red and blue/cyan gradations. This setting can be adjusted from -50 to 50. (Default: ±0)
- [B-G]: The B-G matrix changes the tint of the picture along the yellow/green and blue/magenta gradations. This setting can be adjusted from -50 to 50. (Default: ±0)

[Other Settings] ▶ [White Balance]

Adjusts the amount of white balance throughout the whole image.

- [R Gain]: Adjust the intensity of red tones. This setting can be adjusted from -50 to 50. (Default: ±0)
- [B Gain]: Adjust the intensity of blue tones. This setting can be adjusted from -50 to 50. (Default: ±0)

[Other Settings] ▶ [Color Correction]

The camera detects the characteristics of a certain color (color phase, chroma, area and Y level) and corrects them when recording. You can set the color correction for up to two different areas (A and B). While adjusting one of the [Area A Setting] or [Area B Setting] settings, a zebra pattern will appear on the LCD screen or a monitor connected to the MON. terminal over areas of the image detected as having the characteristics specified for area A or area B.

- [Select Area]: Selects the area or areas to correct. Available options are [Area A], [Area B] and [Area A&B]. Select [Off] to turn this setting off. (Default: [Off])
- [Area A Setting Phase], [Area B Setting Phase]: Adjusts the color phase for area A or B, respectively. This setting can be adjusted from 0 to 31. (Default: 0)
- [Area A Setting Chroma], [Area B Setting Chroma]: Adjusts the color saturation for area A or B, respectively. This setting can be adjusted from 0 to 31. (Default: 16)
- [Area A Setting Area], [Area B Setting Area]: Adjusts the color range for area A or B, respectively. This setting can be adjusted from 0 to 31. (Default: 16)

[Area A Setting Y Level], [Area B Setting Y Level]: Adjusts the brightness for area A or B, respectively. This setting can be adjusted from 0 to 31. (Default: 16)

[Area A Revision Level], [Area B Revision Level]: Adjusts the amount of correction to the color saturation in area A or B, respectively. This setting can be adjusted from -50 to 50. (Default: ±0)

[Area A Revision Phase], [Area B Revision Phase]: Adjusts the amount of correction to the color phase in area A or B, respectively. This setting can be adjusted from -18 to 18. (Default: ±0)

[Other Settings] ➤ [Other Functions]

[Setup Level]: Adjusts the black level set by the [Black] ➤ [Master Pedestal] setting. This setting can be adjusted from -50 to 50. (Default: ±0)

[Over 100%]: This function determines how the camera handles video signals exceeding 100%. Available options are [Through] to do nothing, [Clip] to clip the signal at 100%, and [Press] to compress a signal of up to 108% down to 100% levels. (Default: [Through])

NOTES

- If [CP Custom Picture] ➤ [Other Settings] ➤ [Activate] is set to [On], when an optional RC-V100 Remote Controller is connected to the camera, the following custom picture settings can be changed using the buttons and dials on the remote controller.
 - [Other Settings] ➤ [Black] ➤ [Master Pedestal], [Master Black Red], [Master Black Blue]
 - [Other Settings] ➤ [Black Gamma] ➤ [Level]
 - [Other Settings] ➤ [Knee] ➤ [Slope], [Point] (only when [Knee] ➤ [Activate] is set to [On])
 - [Other Settings] ➤ [Sharpness] ➤ [Level]
 - [Other Settings] ➤ [White Balance] ➤ [R Gain], [B Gain]

Customizing Functions and Onscreen Displays

Customize the camera to match your shooting style and needs. Use the [🔧 System Setup] ➤ [Custom Function] settings to adjust how some of the camera's controls and functions operate. Similarly, use the [📷 Picture/Terminals Setup] ➤ [Custom Display 1] or [Custom Display 2] settings to customize the onscreen displays that appear during recording.

Customizing Functions

The following table describes which functions can be customized using [Custom Function].

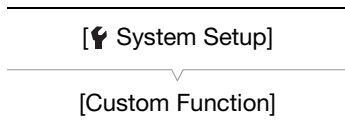

Operating modes: CAMERA MEDIA *

* Only [SELECT Dial Dir.] can be changed in this mode.

- 1 Open the [Custom Function] submenu.
[🔧 System Setup] ➤ [Custom Function]
- 2 Select the desired function.
- 3 Change the setting option and then press SET.

Customizable functions with [Custom Function]

Menu item	Description
[Camera Control Dial]	Selects the function of the control dial on the camera.
[Grip Control Dial]	Selects the function of the control dial on the grip unit.
[Camera Control Dial Dir.]	Changes the direction of the adjustment when operating the control dial on the camera.
[Grip Control Dial Dir.]	Changes the direction of the adjustment when operating the control dial on the grip unit.
[SELECT Dial Dir.]	Changes the direction of the adjustment when operating the SELECT dial.
[Retract Lens]	When an optional Canon EF 40mm f/2.8 STM or EF-S 24mm f/2.8 STM lens is attached to the camera and the focus mode switch on the lens is set to AF, if this setting is set to [On], the lens will retract fully when the camera is turned off.
[3D Rec Mode]	When using another C300 Mark II camera to shoot in 3D, this function corrects any lags in the video and audio signals output from the REC OUT terminal or MON. terminal.
[Scan Reverse Rec]	Inverts the recorded image horizontally and/or vertically.
[Displayed Units]	Changes the distance units used in camera displays between meters and feet.
[OSD Recording (CFast)]	Selects the onscreen displays (date, time, time code, or a combination of them) that will be recorded with primary clips on the CFast card exactly as they appear on the screen. Onscreen displays will not be recorded during slow & fast motion recording mode.
[START/STOP Button] ➤ [Camera], [Grip], [Monitor]	Independently enables or disables the use of individual START/STOP buttons.
[Key Lock]	Selects whether to lock all buttons (including START/STOP buttons) or all buttons with the exception of currently enabled START/STOP buttons) (📖 55).

Customizing Onscreen Displays

For details on which onscreen displays can be customized, refer to *Onscreen Displays* (📖 55), *[Custom Display]* explanations (📖 187).

Operating modes: CAMERA MEDIA

1 Open the desired customized displays submenu.

[Picture/Terminals Setup] ➡ [Custom Display 1] or [Custom Display 2] (CAMERA mode), or [Custom Display] (MEDIA mode)

2 Select the desired onscreen display.

3 Change the setting option and then press SET.

[Picture/Terminals Setup]

In CAMERA mode
 [Custom Display 1]
 [Custom Display 2]

In MEDIA mode
 [Custom Display]

Saving and Loading Camera Settings

After you adjust settings in the various menus, you can save those settings in the camera or on an SD card. You can load those settings at a later date or on another C300 Mark II camera so that you can use that camera in the exact same way.

Operating modes: CAMERA MEDIA

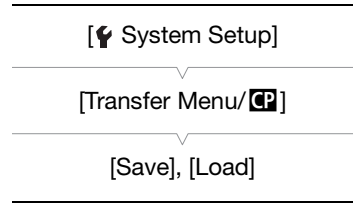

Saving Camera Settings

1 Open the [Save] submenu.

[System Setup] ➤ [Transfer Menu/CP] ➤ [Save]

2 Select [To Camera] or [To SD] and then press SET.

3 Select [OK] and press SET.

- The camera's menu settings will be saved to the selected destination. If menu settings were previously saved, the old file will be overwritten by the current menu settings.

4 When the confirmation message appears, press SET.

Loading Camera Settings

1 Open the [Load] submenu.

[System Setup] ➤ [Transfer Menu/CP] ➤ [Load]

2 Select [From Camera] or [From SD] and then press SET.

3 Select [OK] and press SET.

- The camera's menu settings will be replaced by the settings saved on the selected source. Then, the screen will turn black momentarily and the camera will restart.

NOTES

- The following menu settings are not saved with this operation when the passwords have been set by the user. (Default passwords are saved.)
 - All settings configured under [System Setup] ➤ [Network Settings] ➤ [Connection Settings] in CAMERA mode
 - Encryption keys/passwords under [System Setup] ➤ [Network Settings] ➤ [Connection Settings] in MEDIA mode
 - Passwords under [System Setup] ➤ [Network Settings] ➤ [Browser Remote] ➤ [Users Settings]
- When menu settings are loaded with this operation, even protected custom picture files in the camera will be replaced.
- Camera settings files are exclusively compatible for use only with C300 Mark II cameras.

Playback

This section explains how to play back clips with the camera. For details on playing back clips using an external monitor, refer to *Connecting to an External Monitor or Recorder* (163). For details on viewing photos on the SD card, refer to *Viewing Photos* (177).

Operating modes: CAMERA MEDIA

Clip Index Screen

Playback functions are accessed from the clip index screen. To open the clip index screen, set the camera to MEDIA mode. If the CFast card contains clips recorded at a system frequency other than the one currently used by the camera, you will not be able to play back the clips. In such case, change the camera's system frequency (62) to match the recordings on the CFast card.

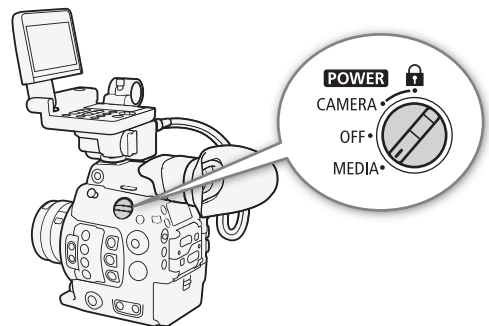

Set the **POWER** switch to MEDIA.

- The camera switches to MEDIA mode and the clip index screen appears.

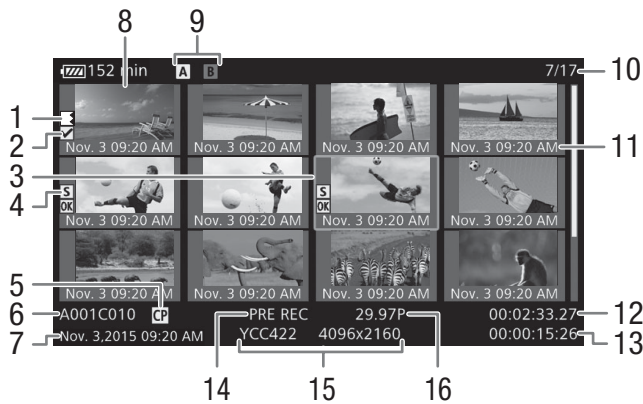

- | | |
|---|---|
| <ol style="list-style-type: none"> 1 Relay recording: Appears when a clip begins on one CFast card and continues on the other. (📖 50) 2 mark/ mark (📖 105, 154) 3 Orange selection frame 4 Shot mark (📖 105, 158) 5 Embedded custom picture file (📖 134) 6 Clip identification (camera index, reel number and clip number) (📖 59) 7 Recording date and time 8 Clip thumbnail | <ol style="list-style-type: none"> 9 Recording media <ul style="list-style-type: none"> Primary clips: CFast card (the one currently selected appears in white) Proxy clips: SD card 10 Clip number / Total number of clips 11 Recording date (month and day only) and time 12 Clip's start time code 13 Clip duration 14 Special recording mode (📖 113) 15 Color sampling and resolution (📖 62) 16 Frame rate* (📖 62) |
|---|---|

* For clips recorded using slow & fast motion recording, the shooting frame rate and playback frame rate will both be displayed.

Switching Between the CFast Card Slots

If both CFast card slots contain a CFast card, you can switch between them as necessary.

Operating modes: CAMERA MEDIA

Press the **SLOT SELECT** button.

- The access indicator of the selected CFast card slot will illuminate in green.

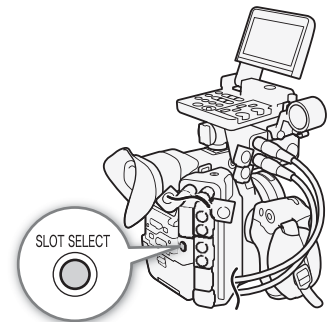

Switching to Other Index Screens

The clip index screen shows primary clips recorded on the currently selected CFast card. From the clip index screen you can switch to the following index screens to view just some of the clips or other types of recordings.

Mark] index screen: Only clips on the same CFast card tagged with an mark.

Mark] index screen: Only clips on the same CFast card tagged with a mark.

[XF-AVC Proxy] index screen: Proxy clips on the SD card.

[Photos] index screen: Photos on the SD card.

1 Press the **INDEX** button.

- From the clip index screen: The index screen selection menu will appear.

From other index screens: The camera will return to the clip index screen. The rest of the procedure is not necessary.

2 Select the desired index screen and then press **SET**.

- The selected index screen appears.
- Select [Cancel] instead to cancel the operation.
- Press the **INDEX** button again to return to the clip index screen.

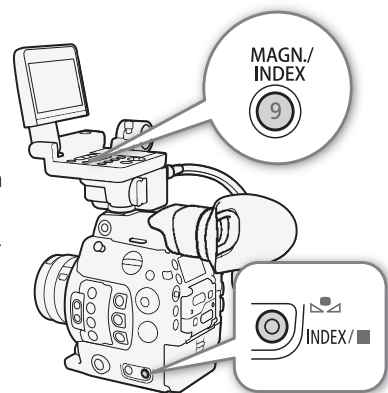

Playing Back Clips

After you select a clip to play back from the index screen, you can control the playback with the buttons on the monitor unit. If the monitor unit is not attached, you can control the playback with the buttons on the camera (play/pause/stop only) or with the joystick and onscreen joystick guide (151).

1 Move the orange selection frame to the clip you want to play back.

2 Press the ►/|| button to start playback.

- Playback will start from the clip selected and continue until the end of the last clip in the index screen. When the last frame of the last clip is reached, playback will be paused.
- Press the ►/|| button again or press SET to pause/resume the playback.
- Press the ■ button to stop the playback and return to the index screen.

! IMPORTANT

- Observe the following precautions while an access indicator is illuminated in red. Failure to do so may result in permanent data loss.
 - Do not disconnect the power source or turn off the camera.
 - Do not open the card slot cover of the card being accessed and do not remove the card.

i NOTES

- You may notice brief stops in video or audio playback between clips.

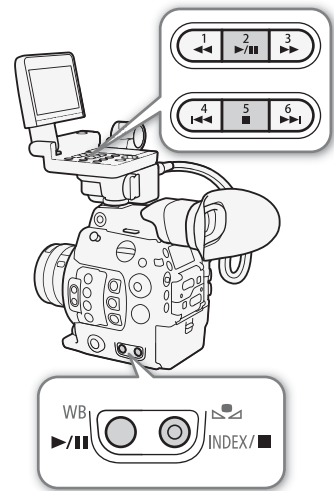

Onscreen Displays

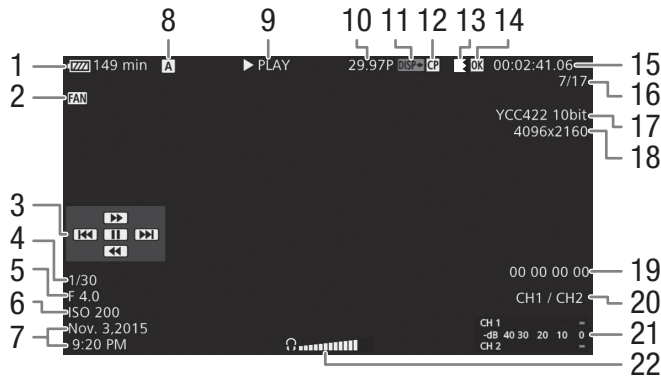

- | | |
|--|--|
| <ul style="list-style-type: none"> 1 Remaining battery time (56) 2 Fan operation (61) 3 Joystick guide (151) 4 Shutter speed¹ (65) 5 Aperture value¹ (70) 6 ISO Speed/Gain¹ (67) 7 Recording date and time² 8 Recording media
 <ul style="list-style-type: none"> [A], [B] Primary clips: CFast card [SD] Proxy clips: SD card 9 Playback operation 10 Frame rate³ (62) 11 Onscreen displays superimposed on video output (168) | <ul style="list-style-type: none"> 12 Embedded custom picture file (134) 13 Relay recording 14 [OK] mark/[X] mark (105, 154) 15 Time code (88) 16 Clip number / Total number of clips 17 Color sampling (62) 18 Resolution (62) 19 User bit (91) 20 Audio output channel (169) 21 Audio level meter⁴ 22 Headphones volume (only while adjusting the volume) |
|--|--|

¹ Only when [Picture/Terminals Setup] [Custom Display] [Camera Data] is set to [On].
² Only when [Picture/Terminals Setup] [Custom Display] [Date/Time] is set to [On].
³ For clips recorded using slow & fast motion recording, the shooting frame rate and playback frame rate will both be displayed.
⁴ Only when [Picture/Terminals Setup] [Custom Display] [Audio Level] is set to [On].

7 Playback operation

- ▶ PLAY Playback
- ⏸ PAUSE Playback pause
- ◀◀/▶▶ Frame reverse/Frame advance
- F FWD ▶▶ Fast playback*
- ◀◀ F REV Fast reverse playback*

* The playback speed (x5, x15 or x60) will also appear in the indicator.

9 Relay recording

Appears when a clip begins on one CFast card and continues uninterrupted on the other. [A] indicates the first part of the recording, [B] indicates the middle part(s) and [C] indicates the last part.

NOTES

- You can repeatedly press the DISP. button on the monitor unit or an assignable button set to [Display] (131) to switch the onscreen displays in the following sequence.
 Show all onscreen displays → hide the joystick guide → hide all onscreen displays*

* Except for momentary displays like the clip number when the playback switches to a different clip, or the time code and playback operation at the end of the playback.

Playback Controls

The following playback types are available using either the playback buttons on the monitor unit ("Buttons" in the table below) or the onscreen joystick guide and any of the joysticks.

Playback type	Operation
Fast playback	Buttons: Press the ◀◀ or ▶▶ button. Joystick: During playback, push the joystick up or down. Repeat to increase the playback speed to approximately 5x → 15x → 60x the normal speed.
Frame advance/reverse	Joystick: During playback pause, push the joystick up or down.
Skip to the beginning of the next clip	Buttons: Press the ▶▶▶ button. Joystick: Push the joystick right.
Skip to the beginning of the current clip	Buttons: Press the ◀◀◀ button. Joystick: Push the joystick left.
Skip to the previous clip	Buttons: Press the ◀◀◀ button twice. Joystick: Push the joystick left twice.
Return to playback mode	Buttons: Press the ▶/ button. Joystick: Press the joystick itself (SET button).

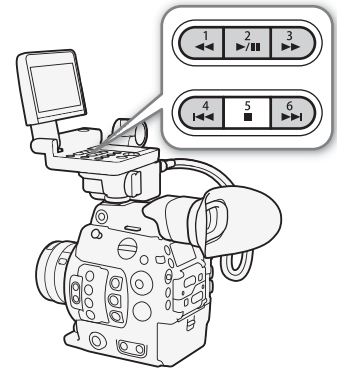

151

i NOTES

- There is no audio during any of the playback types listed in the previous table.
- During some playback modes, you may notice some anomalies (blocky video artifacts, banding, etc.) in the playback picture.
- The speed indicated on the screen is approximate.
- If the clip's bit rate setting includes Long GOP compression, during frame advance, the time advanced between frames depends on the video configuration used: 0.2 seconds (when the frame rate is 59.94P), 0.24 seconds (when the frame rate is 50.00P) and approximately 0.5 seconds for other video configurations.
- You can press the DISP. button on the monitor unit or an assignable button set to [Display] (📖 131) to turn the joystick guide display on and off.

Adjusting the Volume

You can connect headphones to the 📞 (headphone) terminal to listen to the audio during playback. Adjust the headphone volume with the [🎧] Audio Setup ➡ [Audio Output] ➡ [Headphone Volume] setting. If you set an assignable button to [Headphones +] or [Headphones -] (📖 131), you can press the button to adjust the headphone volume without using the menu.

The audio signal will also be output from the REC OUT terminal, MON. terminal and HDMI OUT terminal.

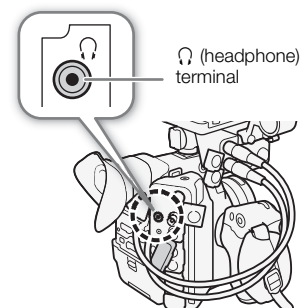

i NOTES

- For details on changing the audio channel, refer to *Audio Output* (📖 169).

Clip Operations

Besides playing back a clip, you can perform other operations such as deleting a clip or displaying clip information. This is done through the clip menu, which contains different functions depending on the index screen. You can use the functions in the [📷 Recording/Media Setup] menu to perform some of the operations on all the clips. Refer to the following table for available functions and refer to the following pages for more details of the functions.

Operating modes: CAMERA MEDIA

Clip Menu Functions

Menu item	Description	Index screen			📖
		Clip	[OK Mark]/ [✓ Mark]	[XF-AVC Proxy]	
[Cancel]	Closes the clip menu.	●	●	●	–
[Display Clip Info]	Displays the clip information screen.	●	●	●	153
[Add OK Mark]/ [Delete OK Mark]	Adds or deletes an OK mark.	●	● ¹	–	154, 155
[Add ✓ Mark]/ [Delete ✓ Mark]	Adds or deletes a ✓ mark.	●	● ²	–	
[Copy Clip]	Copies a clip from one CFast card to the other.	●	● ¹	–	155
[Delete Clip]	Deletes a clip.	●	● ²	●	156
[Shot Mark]	Displays an index screen of all the frames of a clip that have either shot mark.	●	●	–	157
[Shot Mark 1]	Displays an index screen of all the frames of a clip that have the S1 mark.	●	●	–	
[Shot Mark 2]	Displays an index screen of all the frames of a clip that have the S2 mark.	●	●	–	
[Expand Clip]	Displays an index screen that shows frames of a clip at a fixed interval.	●	●	–	158
[Delete User Memo]	Deletes the user memo and GPS information of a clip.	●	●	●	156
[Copy CP File]	Copies the custom picture file from a clip to the camera.	●	●	●	157

¹ [OK Mark] index screen only.

² [✓ Mark] index screen only.

Menu item	Description	Index screen		📖
		[Shot Mark] ³	[Expand Clip]	
[Cancel]	Closes the clip menu.	●	●	–
[Add Shot Mark 1]/ [Del. Shot Mark 1]	Adds or deletes a S1 mark.	●	●	158, 159
[Add Shot Mark 2]/ [Del. Shot Mark 2]	Adds or deletes a S2 mark.	●	●	
[Fewer Index Pics]	Decreases the number of thumbnails that are displayed.	–	●	158
[More Index Pics]	Increases the number of thumbnails that are displayed.	–	●	
[Pause]	Switches to playback of a clip with playback paused on the selected frame.	●	●	–

³ Includes also the [Shot Mark 1] and [Shot Mark 2] index screens.

Using the Clip Menu

1 Select a clip and then press SET.

- The clip menu appears. Available functions depend on the index screen and which functions are enabled.

2 Select the desired function and then press SET.

- The function is enabled. For some functions, further action may be required. Follow the onscreen directions.
- Press the CANCEL button instead to return to the clip index screen.

! IMPORTANT

- Observe the following precautions while an access indicator is illuminated in red. Failure to do so may result in permanent data loss.
 - Do not disconnect the power source or turn off the camera.
 - Do not open the card slot cover of the card being accessed and do not remove the card.

i NOTES

- To perform operations on proxy clips recorded on an SD card, make sure the LOCK switch on the SD card is not set to prevent writing.

Displaying Clip Information

Select [Display Clip Info] in the clip menu to display the selected clip's information screen ([Clip Info] screen). Push the joystick left/right to switch to the previous/next clip. When you have finished, press the CANCEL button to return to the clip index screen.

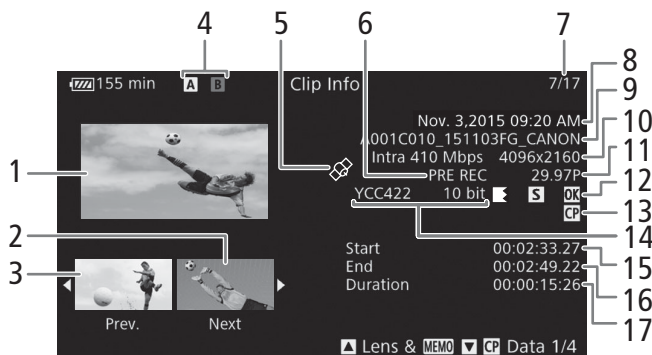

- | | |
|---|---|
| 1 Thumbnail of the selected clip | 8 Recording date and time |
| 2 Thumbnail of the next clip | 9 Clip file name (59) |
| 3 Thumbnail of the previous clip | 10 Compression, bit rate and resolution (62) |
| 4 Recording media | 11 Frame rate* (62) |
| [A B] Primary clips: CFast card (the one currently selected appears in white) | 12 Relay clip (150), shot mark (105, 158), |
| [SD] Proxy clips: SD card | OK mark / [] mark (105, 154) icons |
| 5 Clip geotagged with GPS information (108, 128) | 13 Embedded custom picture file (134) |
| 6 Special recording mode (113) | 14 Color sampling (62) |
| 7 Clip number / Total number of clips | 15 Clip's start time code |
| | 16 Clip's end time code |
| | 17 Clip duration |

* For clips recorded using slow & fast motion recording, the shooting frame rate and playback frame rate will both be displayed.

Displaying the Lens Information and User Memo

From the [Clip Info] screen, push the joystick up or turn the SELECT dial up to display the [Lens & **MEMO**] screen. In this screen you can check details about the lens used to record the clip. If the clip has an embedded user memo, you will see the user memo content in this screen as well. Push the joystick up or turn the SELECT dial up to return to the [Clip Info] screen.

Displaying Custom Picture Settings

When displaying the [Clip Info] screen of a clip that has a custom picture file recorded with it, push the joystick down or turn the SELECT dial down to display the first of four screens with the clip's custom picture settings ([**CP** Data 1/4] screen). Push the joystick down or turn the SELECT dial down to display the other three [**CP** Data] screens → [Lens & **MEMO**] screen → [Clip Info] screen.

Adding **OK** Marks or **✓** Marks

If you add an OK mark (**OK**) or check mark (**✓**) to primary clips recorded on a CFast card, you can later display an index screen that shows only the clips with an **OK** mark or only the clips with a **✓** mark. Furthermore, you cannot delete clips with an **OK** mark so you can use this mark also to protect important clips.

Adding an **OK** Mark or **✓** Mark during Playback

To add an OK mark (**OK**) or check mark (**✓**) to a clip during playback or playback pause, you must first set an assignable button to [Add **OK** Mark] or [Add **✓** Mark] in advance.

- 1 Set an assignable button to [Add **OK** Mark] or [Add **✓** Mark] (📖 131).
 - To add both types of clip marks (to different clips), set one assignable button to [Add **OK** Mark] and another assignable button to [Add **✓** Mark].
- 2 Open the clip index screen for primary clips and select the desired clip.
- 3 During playback or playback pause, press the assignable button to add the clip mark.
 - A message indicating the clip mark will appear and the selected clip mark will be added to the clip.
 - Adding a clip mark to a clip during playback will pause the playback.

Adding an **OK** Mark or **✓** Mark from the Index Screen

- 1 Open the clip index screen for primary clips, select the desired clip and then press SET to open the clip menu.
- 2 Select [Add **OK** Mark] or [Add **✓** Mark] and then press SET.
 - The clip information screen appears and it prompts you to confirm the operation.
- 3 Select [OK] and then press SET.
 - The screen changes back to the clip index screen and an **OK** mark or **✓** appears next to the selected clip's thumbnail.
 - Select [Cancel] instead to cancel the operation.

NOTES

- A clip cannot have both an **OK** mark and **✓** mark at the same time. When you add a **✓** mark to a clip with an **OK** mark, the **OK** mark will be deleted. Similarly, when you add an **OK** mark to a clip with a **✓** mark, the **✓** mark will be deleted.

Deleting **OK** Marks or **✓** Marks

Deleting an **OK** Mark or **✓** Mark from a Clip

- 1 Open the clip index screen for primary clips, select the desired clip and then press SET to open the clip menu.
- 2 Select [Delete **OK** Mark] or [Delete **✓** Mark] and then press SET.
 - The clip information screen appears and it prompts you to confirm the operation.
- 3 Select [OK] and then press SET.
 - The screen changes back to the clip index screen and the selected mark is deleted.
 - Select [Cancel] instead to cancel the operation.

Deleting **OK** Marks from All Clips

- 1 Open the [Delete All **OK** Marks] submenu.
[Recording/Media Setup] ➤ [Delete All **OK** Marks]
- 2 Select [OK] and then press SET.
 - All **OK** marks from clips on the selected CFast card will be deleted.
 - Select [Cancel] instead to cancel the operation.
 - While the **OK** marks are being deleted, you can press SET to cancel.
- 3 When the confirmation message appears, press SET.

[Recording/Media Setup]

[Delete All **OK** Marks]

Copying Clips

You can copy primary clips from one CFast card to the other.

Copying a Single Clip

- 1 Open the clip index screen for primary clips, select the desired clip and then press SET to open the clip menu.
- 2 Select [Copy Clip] and then press SET.
 - The clip information screen appears and it prompts you to confirm the operation. You can also check the available space on both CFast cards.
- 3 Select [OK] and then press SET.
 - Select [Cancel] instead to cancel the operation.
 - While the clip is being copied, you can press SET to cancel.
- 4 When the confirmation message appears, press SET.
 - The selected clip is copied to the other CFast card.

Copying All Clips or All Clips with an **OK** Mark

- 1 Open the [Copy All Clips] or [Copy **OK** Clips] submenu.
[Recording/Media Setup] ➤ [Clips] ➤ [Copy All Clips] or [Copy **OK** Clips]
- 2 Select [OK] and then press SET.
 - All the applicable clips on the selected CFast card will be copied to the other CFast card.
 - Select [Cancel] instead to cancel the operation.
 - While the clips are being copied, you can press SET to cancel.
- 3 When the confirmation message appears, press SET.

[Recording/Media Setup]

[Clips]

[Copy All Clips]
[Copy **OK** Clips]

i NOTES

- You cannot copy a clip if either CFast card slot cover is open.

Deleting Clips

You can delete clips from a CFast or SD card, except for primary clips with an **OK** mark. To delete such clips, delete the **OK** mark beforehand (📖 155).

156

Deleting a Single Clip

- 1 Select the desired clip and then press SET to open the clip menu.
- 2 Select [Delete Clip] and then press SET.
 - The clip information screen appears and it prompts you to confirm the operation.
- 3 Select [OK] and then press SET.
 - Select [Cancel] instead to cancel the operation.
 - While the clip is being deleted, the operation cannot be canceled.
- 4 When the confirmation message appears, press SET.

Deleting All Clips

- 1 Open the [Delete All Clips] submenu.
[📷 Recording/Media Setup] ➤ [Clips] ➤ [Delete All Clips]
- 2 Select [OK] and then press SET.
 - All the clips on the selected CFast card (except for primary clips with an **OK** mark) or SD card will be deleted.
 - Select [Cancel] instead to cancel the operation.
 - While the clips are being deleted, you can press SET to cancel.
- 3 When the confirmation message appears, press SET.

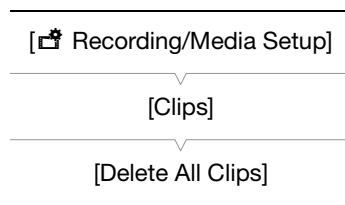

Deleting the User Memo and GPS Information

- 1 Open the clip index screen for primary clips, select the desired clip and then press SET to open the clip menu.
- 2 Select [Delete User Memo] and then press SET.
 - The [Delete User Memo] screen appears and it prompts you to confirm the operation.
- 3 Select [OK] and then press SET.
 - The user memo and GPS information is deleted and the screen changes back to the clip index screen.
 - Select [Cancel] instead to cancel the operation.

Copying a Custom Picture File Embedded in a Clip

You can copy the custom picture file embedded in a clip to the camera.

- 1 Select the desired clip and then press SET to open the clip menu.
- 2 Select [Copy **CP** File] and then press SET.
 - The [**CP** Data 1/4] screen appears with the orange selection frame indicating a custom picture file in the camera.
 - If you set an assignable button to [Custom Picture] (📖 131), you can press the button to open the clip menu and display the [**CP** Data 1/4] screen directly.
 - You can push the joystick up/down or turn the SELECT dial to display the other three [**CP** Data] screens.
- 3 Push the joystick left/right to select the custom picture file that you wish to overwrite and then press SET.
- 4 Select [OK] and then press SET.
 - The selected file will be overwritten by that embedded in the clip.
 - Select [Cancel] instead to cancel the operation.
- 5 When the confirmation message appears, press SET.

i NOTES

- You cannot copy the custom picture file in a clip to a protected custom picture file.

Displaying an Index Screen of Shot Marks

After you add shot marks to a primary clip recorded on a CFast card, you can display an index screen that contains all the frames in the clip with either shot mark, only the **S1** mark or only the **S2** mark. When you play back a clip from this index screen, playback will start from the frame with the shot mark. You can also perform other operations from this index screen, such as adding and deleting shot marks.

- 1 Select a clip with the **S** icon and then press SET to open the clip menu.
- 2 Select [Shot Mark] and then press SET.
 - The [Shot Mark] index screen appears, which contains all the frames with shot marks in the clip. Select instead [Shot Mark 1] to display an index screen only of the frames with the **S1** mark or [Shot Mark 2] to display an index screen only of the frames with the **S2** mark.
 - The time code under the thumbnail indicates the time code of the frame with the shot mark.
 - Press the INDEX button or CANCEL button to return to the clip index screen.



i NOTES

- After you finish playing back a clip from this index screen, the index screen that was open before the [Shot Mark] index screen will appear.

Displaying a Frame Index Screen of a Single Clip

You can display an index screen of a single primary clip recorded on a CFast card, broken down as frames at fixed intervals. This is useful when you have a long clip or wish to play back a clip from a certain point. You can change how many thumbnails are displayed. You can also perform other operations from this index screen, such as adding and deleting shot marks.

1 Select a clip recorded on a CFast card and then press SET to open the clip menu.

2 Select [Expand Clip] and then press SET.

- The [Expand Clip] index screen appears, which shows thumbnails of frames taken from the clip at fixed intervals. The time code under the thumbnail indicates the time code of the frame.
- You can change the fixed interval between frames by showing more or fewer thumbnails. To show more thumbnails, open the clip menu and select [More Index Pics] and then press SET. To show fewer thumbnails, select [Fewer Index Pics] and then press SET.
- Press the INDEX button or CANCEL button to return to the clip index screen.

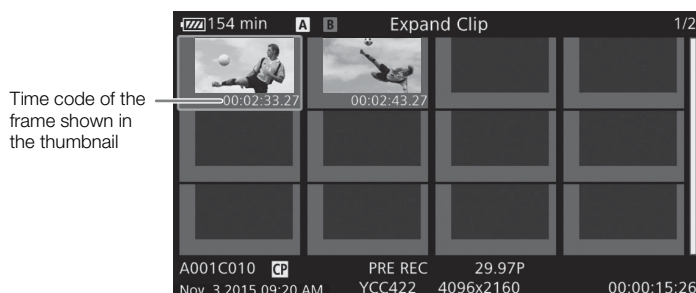
**i** NOTES

- After you finish playing back a clip from this index screen, the index screen that was open before the [Expand Clip] index screen will appear.

Adding Shot Marks

You can add shot marks (S1, S2 or both) to frames in a primary clip recorded on a CFast card that you want to set apart. Later, you can display an index screen that shows only the clips with a S1 mark, only the clips with a S2 mark, or only clips with either shot mark.

Adding Shot Marks during Playback

To add an S1 mark or S2 mark to a clip during playback or playback pause, you must first set an assignable button to [Add Shot Mark 1] or [Add Shot Mark 2] in advance.

1 Set an assignable button to [Add Shot Mark 1] or [Add Shot Mark 2] (131).

2 During playback or playback pause, press the assignable button at the point in the clip to add the shot mark.

- A message indicating the shot mark appears on the screen and the shot mark is added to the clip.
- Adding a shot mark to a clip during playback will pause the playback.

Adding Shot Marks from the Index Screen

- 1 Open the [Shot Mark] index screen or [Expand Clip] index screen.
- 2 Select the desired frame (thumbnail) and then press SET to open the clip menu.
- 3 Select [Add Shot Mark 1] or [Add Shot Mark 2] and then press SET.
 - The clip information screen appears and it prompts you to confirm the operation.
- 4 Select [OK] and then press SET.
 - The screen changes back to the previous index screen and the selected shot mark appears next to the selected clip's thumbnail.
 - Select [Cancel] instead to cancel the operation.

NOTES

- Up to 100 shot marks (**S1** and **S2** marks combined) can be added to a single clip.
- There may be up to a 0.5 second delay between the frame shown when you press the assignable button and the frame to which the camera adds the shot mark.

Deleting Shot Marks

- 1 Open the [Shot Mark] index screen or [Expand Clip] index screen.
- 2 Select the desired frame (thumbnail) and then press SET to open the clip menu.
- 3 Select [Del. Shot Mark 1] or [Del. Shot Mark 2] and then press SET.
 - The clip information screen appears and it prompts you to confirm the operation.
- 4 Select [OK] and then press SET.
 - The selected mark is deleted and the screen changes back to the previous index screen.
 - If a frame has no shot marks, it will no longer appear in the [Shot Mark] index screen.
 - Select [Cancel] instead to cancel the operation.

Video Output Configuration

The video signal output from the REC OUT terminal, MON. terminal and HDMI™ OUT terminal, depends on the clip's video configuration) and on various menu settings.

Recording Video Signal Configuration and Video Output Configuration by Terminal

Refer to the following table for the video output configuration from each terminal, depending on the recording video configuration used.

Operating modes: CAMERA MEDIA

[REC OUT 4K RAW Mode] setting ¹	Recording video configuration		Video output configuration				
	Frame rate ²	Resolution	REC OUT terminal ³	MON. terminal ⁴			HDMI OUT terminal ^{4, 6}
				[Output] setting ⁵			
				[4K RAW Priority]	[2048x1080/ 1920x1080]	[1920x1080]	
4K RAW	29.97P 25.00P	4096x2160 2048x1080	4096x2160 RAW 10 bit	4096x2160 RAW 10 bit	2048x1080 YCbCr 4:2:2 10 bit	1920x1080, 720x480 (59.94P only), 720x576 (50.00P only)	
	24.00P 23.98P	3840x2160 1920x1080	3840x2160 RAW 10 bit	3840x2160 RAW 10 bit	1920x1080 YCbCr 4:2:2 10 bit		
2K	29.97P 25.00P	4096x2160 2048x1080	2048x1080/RGB 4:4:4 12 or 10 bit, YCbCr 4:2:2 10 bit	2048x1080 YCbCr 4:2:2 10 bit			
	24.00P 23.98P	3840x2160 1920x1080	1920x1080/RGB 4:4:4 12 or 10 bit, YCbCr 4:2:2 10 bit	1920x1080 YCbCr 4:2:2 10 bit			
	59.94P 50.00P	2048x1080	2048x1080/RGB 4:4:4 12 or 10 bit, YCbCr 4:2:2 10 bit	2048x1080 YCbCr 4:2:2 10 bit			
	59.94P 59.94i 50.00P 50.00i	1920x1080	1920x1080/RGB 4:4:4 12 or 10 bit, YCbCr 4:2:2 10 bit	1920x1080 YCbCr 4:2:2 10 bit			

¹ [Recording/Media Setup] ➤ [REC OUT 4K RAW Mode].

² The frame rate of the video output will be the same as that used for recording (except during slow & fast motion recording).

³ The color sampling will be determined by the option selected for the [Recording/Media Setup] ➤ [Resolution/Color Sampling] setting.

⁴ When the MON. terminal is not set to 4K RAW output, onscreen displays and assistance functions like peaking and zebra pattern can be output to an external monitor.

⁵ [Picture/Terminals Setup] ➤ [MON. Terminal] ➤ [Output]. 4K RAW output is available only when the REC OUT terminal's output is also set to 4K RAW output.

⁶ When [Picture/Terminals Setup] ➤ [MON. Terminal] ➤ [Output] is set to [Off], the HDMI OUT terminal's output will be in HD or SD, depending on the capabilities of the external monitor. When the horizontal resolution of the recording video configuration is 4096 or 2048, the sides of the image will be cropped. The color sampling will be set automatically to YCbCr 4:4:4, 8 bit, YCbCr 4:2:2, 8 bit or RGB 4:4:4, 8 bit, depending on the capabilities of the external monitor.

Playback Video Configuration and Video Output Configuration by Terminal

Refer to the following tables for the video output configuration from each terminal, depending on the video configuration of the clip being played back.

162

Operating modes:

Video configuration of the clip		REC OUT terminal/MON. terminal		HDMI OUT terminal*
Resolution	Frame rate	[2048x1080/1920x1080]	[1920x1080]	
4096x2160	29.97P	2048x1080	1920x1080 YCbCr 4:2:2 10 bit	1920x1080, 720x480 (only 59.94P), 720x576 (only 50.00P)
2048x1080	25.00P	YCbCr 4:2:2, 10 bit		
3840x2160	24.00P	1920x1080		
1920x1080	23.98P	YCbCr 4:2:2, 10 bit		
2048x1080	59.94P	2048x1080		
	50.00P	YCbCr 4:2:2, 10 bit		
1920x1080	59.94P / 59.94i	1920x1080		
	50.00P / 50.00i	YCbCr 4:2:2, 10 bit		

* When [Picture/Terminals Setup] ➤ [REC OUT/MON. Terminal] ➤ [Output] is set to [2048x1080/1920x1080] or [1920x1080], the HDMI OUT terminal's output will be in HD; when it is set to [Off], it will be in HD or SD, depending on the capabilities of the external monitor. The color sampling will be set automatically to YCbCr 4:4:4, 8 bit, YCbCr 4:2:2, 8 bit or RGB 4:4:4, 8 bit, depending on the capabilities of the external monitor.

Connecting to an External Monitor or Recorder

When you connect the camera to an external device, be it a monitor (to monitor the recording or for playback) or an external video recorder (for recording), use the terminal on the camera that matches the one you wish to use on the monitor. Then, select the video signal output configuration (📖 161).

Operating modes: CAMERA MEDIA

Connection Diagram

We recommend that you power the camera from a power outlet using the AC adapter.

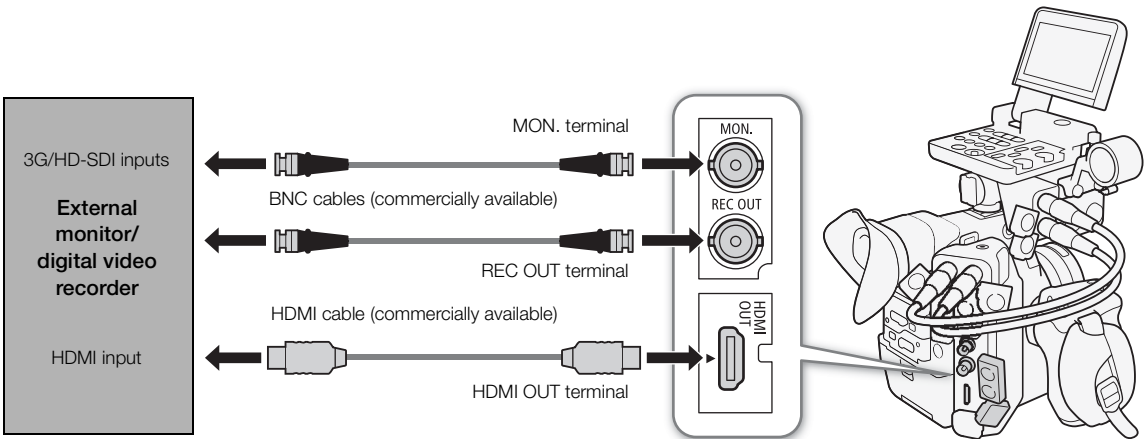

Using the REC OUT terminal or MON. terminal

The digital signal that is output from the REC OUT terminal and MON. terminal includes the video signal, audio signal (4 channels*), time code, metadata and file name information.

* During 4K RAW output, 2-channel 16-bit audio will be output instead. You can select which audio channels to output (□ 169).

Activating the Terminals and Selecting the Output Signals

You can enable output from the REC OUT terminal or MON. terminal independently. Turning the terminals' output off will conserve the battery's power.

To use the REC OUT terminal in **CAMERA** mode

1 Open the [REC OUT 4K RAW Mode] submenu.

[📷 Recording/Media Setup] ➤ [REC OUT 4K RAW Mode]

2 Select [4K RAW] or [2K].

To use the MON. terminal in **CAMERA** mode

1 Open the [Select Monitoring Devices] submenu.

[📺 Picture/Terminals Setup] ➤ [Select Monitoring Devices]

2 Select [MON.+HDMI+LCD(VF)] or [MON.+HDMI+VF] and then press SET.

3 Open the MON. terminal's [Output] submenu.

[📺 Picture/Terminals Setup] ➤ [MON. Terminal] ➤ [Output]

4 Select the desired option and then press SET.

- To use the MON. terminal for 4K RAW output, you must set in advance also the REC OUT terminal to 4K RAW output, using the previous procedure.

To use either terminal in **MEDIA** mode (2K output only)

1 Open the REC OUT and MON. terminals' [Output] submenu.

[📺 Picture/Terminals Setup] ➤ [REC OUT/MON. Terminal] ➤ [Output]

2 Select the desired option and then press SET.

Options

REC OUT terminal

[4K RAW]: Outputs 4K RAW video. This setting is only available when [📷 Custom Picture] ➤ [Main Settings] ➤ [Gamma] has been set to [Canon Log 2] or [📷 Custom Picture] ➤ [Preset] has been set to one of the [Canon Log 2:] options.

[2K]: Outputs 2K video.

MON. terminal

[4K RAW Priority]: When the REC OUT terminal's output is set to 4K RAW output, outputs 4K RAW video. Otherwise, outputs 2K video.

[2048x1080/1920x1080]: Outputs video with a resolution of 2048x1080 or 1920x1080 regardless of the REC OUT terminal's output.

[1920x1080]: Outputs 1920x1080 (Full HD) video regardless of the REC OUT terminal's output. When the horizontal resolution of the recording video configuration is 4096 or 2048, the sides of the image will be displayed letterboxed.

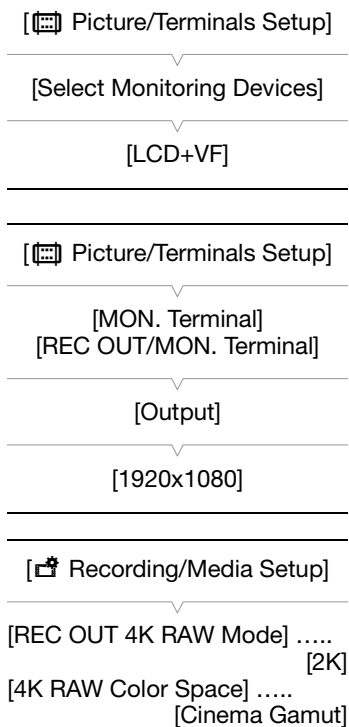

Preparations for Connecting an External Monitor

Only when using the MON. terminal, you can output various assistance displays (onscreen markers, zebra patterns, peaking, magnification, onscreen displays, B&W image) in order to check them also on an external monitor.

If you use a professional 4K reference display compatible with this camera's 4K RAW signal, like the optional DP-V2410 Video Display, you can monitor directly the camera's 4K RAW signal without converters or adapters.

Operating modes: CAMERA MEDIA

[] Picture/Terminals Setup

[3G-SDI Mapping]

[Level B]

165

1 Activate the REC OUT terminal and/or MON. terminal and select the desired output (164).

- If you do not intend to use a terminal, select [Off] for its output setting.

2 If you selected 2K output, open the [3G-SDI Mapping] submenu.

[] Picture/Terminals Setup ▶ [3G-SDI Mapping]

3 Select the desired option and then press SET.

- You can select a video output signal compliant with Level A or Level B of the SMPTE ST 425-1 standard.

Preparations for Recording 4K RAW or 2K Video Using an External Recorder

You can connect an external video recorder to the camera's REC OUT terminal or MON. terminal to record 4K* or 2K video. Refer also to the external recorder's instruction manual for details on how to record.

For details about the audio channels that are output, refer to *Audio Output* (169).

* To make 4K recordings, the external recorder must be compatible with Canon RAW files. For the latest information on compatible recorders, visit your local Canon Web site.

Operating modes: CAMERA MEDIA

1 Activate the REC OUT terminal and/or MON. terminal and select the desired output (164).

2 If you selected 4K RAW output, open the [4K RAW Color Space] submenu to select the color space.

[] Recording/Media Setup ▶ [4K RAW Color Space]

3 Select the desired option and then press SET.

- For details about the color space options, refer to the [Color Space] explanation in the custom picture section (138).

NOTES

- Depending on the external recorder, you may not be able to record at the desired video configuration.
- After you connect the camera to the external recorder, make a test recording first to check that audio and video are recorded correctly on the external recorder.
- You can set [] Recording/Media Setup ▶ [Rec Command] to [On] to use the camera's START/STOP button to control also the recording operation of an external recorder connected to the REC OUT terminal or MON. terminal.
- During 4K RAW output, the audio output signal will be 2-channel linear PCM audio (16-bit, 48 kHz sampling). We recommend using instead the 4-channel linear PCM audio (16- or 24-bit sampling) that is recorded in the camera with the primary clips or proxy clips.
- **Restrictions regarding 4K RAW output:**
 - 4K RAW video output is not available during slow & fast motion recording in cropped mode.
 - 4K RAW video will not be output when the frame rate used exceeds 30.00P.
 - When 2K RGB 4:4:4 video is being output from the REC OUT terminal, video output from the MON. terminal will be a 2K YCbCr video signal.

Using the HDMI OUT Terminal

The HDMI™ OUT terminal also offers a digital connection and outputs both a video and audio signal. The video output signal depends on the MON. terminal's video output setting. You can output also the camera's time code signal and onscreen displays, or change the video output to B&W mode. The audio output signal will be 2-channel linear PCM audio (16-bit*, 48 kHz sampling). You can select which audio channels to output (📖 169).

* Regardless of the [🎵] Audio Setup ➤ [Audio Input] ➤ [Audio Bit Depth] setting (📖 96).

Operating modes: CAMERA MEDIA

In MEDIA mode, no settings need to be changed but the output signal will depend on the [📺] Picture/Terminals Setup ➤ [REC OUT/MON. Terminal] ➤ [Output] setting (📖 162). In CAMERA mode, perform the following procedure to activate the HDMI OUT terminal.

1 Open the [Select Monitoring Devices] submenu.

[📺] Picture/Terminals Setup ➤ [Select Monitoring Devices]

2 Select an option that includes [HDMI] and then press SET.

- If necessary, continue the procedure to activate the output of the time code signal from the HDMI OUT terminal. Otherwise, the rest of the procedure is not necessary.

3 Open the [HDMI Time Code] submenu.

[📺] Recording/Media Setup ➤ [HDMI Time Code]

4 Select [On] and then press SET.

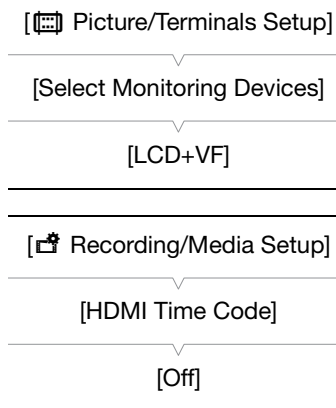

NOTES

- In the following cases, the HDMI OUT terminal's output will switch automatically to HD or SD depending on the capability of the external monitor.
 - In CAMERA mode, when [📺] Recording/Media Setup ➤ [REC OUT 4K RAW Mode] is set to a setting other than [4K RAW] and [📺] Picture/Terminals Setup ➤ [MON. Terminal] ➤ [Output] is set to [Off].
 - In MEDIA mode, when [📺] Picture/Terminals Setup ➤ [REC OUT/MON. Terminal] ➤ [Output] is set to [Off].
- SD output is not available when the frame rate is set to 24.00P.
- The HDMI OUT terminal is for output only. Do not connect the camera to another device's output terminal using the HDMI OUT terminal as this will cause a malfunction.
- Correct operation cannot be guaranteed when connecting the camera to DVI monitors.
- Video may not be output correctly depending on the monitor. In such case, use another terminal.
- You can set both [📺] Recording/Media Setup ➤ [Rec Command] and [HDMI Time Code] to [On] to use the camera's START/STOP button to control also the recording operation of an external recorder connected to the HDMI OUT terminal. The camera's time code signal will be output as well.
- The time code will not be output from the HDMI OUT terminal during SD output or in MEDIA mode.

Applying a LUT to Screens/Video Outputs

While recording using special gamma curves, you can apply a LUT to video output from the REC OUT terminal, MON. terminal or HDMI OUT terminal and to the image displayed on the LCD screen or viewfinder. When a LUT is applied, the displayed image will look as if a standard gamma curve and color space were used, making it easier to check the image on the display device used. To check the image on an external monitor, you will need a monitor that is compatible with the selected color space.



[ Assistance Functions]

[LUT]

[Activate] [Off]
 [MON. & HDMI (2K)] [Off]
 [REC OUT (2K)] [Off]
 [LCD & VF] [Off]

167

Available LUT options by gamma curve and color space

Available LUTs depend on the combination of gamma curve and color space used, whether it was set through one of the [ Custom Picture] ➤ [Preset] settings or through the individual [ Custom Picture] ➤ [Main Settings] ➤ [Gamma] or [Color Space] settings.

[Gamma]	[Color Space]	Available LUTs			
		[BT.709]	[BT.2020]	[DCI]	[ACESproxy10]
[Canon Log 2]	[Cinema Gamut]	●	●	●	●*
	[BT.2020 Gamut]	●	●	–	–
	[DCI-P3 Gamut]	●	–	●	–
	[BT.709 Gamut]	●	–	–	–
[Canon Log]	[BT.709 Gamut]	●	–	–	–
[Wide DR]	[BT.2020 Gamut]	●	–	–	–

* Only when [ Custom Picture] ➤ [Preset] is set to [Canon Log 2: C.Gamut].

Operating modes:

1 Open the LUT's [Activate] submenu.

[ Assistance Functions] ➤ [LUT] ➤ [Activate]

2 Select [On] and then press SET.

3 Select [MON. & HDMI (2K)], [REC OUT (2K)] or [LCD & VF] and then press SET.

4 Select the desired option and then press SET.

- Repeat steps 3 and 4 as necessary to select the LUT applied to other output terminals/displays.
- The gamma curve and color space of the video output will change.
- For the LCD screen and viewfinder, only the [BT.709] LUT is available.
- If a LUT is not needed, select [Off].

Options

Applied LUT	Output Settings with LUT applied		Description
	Gamma curve	Color space	
[BT.709]	Wide DR	BT.709	LUT for viewing on the camera's LCD screen and viewfinder or external monitors compatible with BT.709 specifications.
[BT.2020]	Wide DR	BT.2020	LUT for viewing on external monitors compatible with ITU-R BT.2020 standards, which define parameters for ultra-high-definition television (4K/8K).
[DCI]	DCI	DCI-P3	LUT for viewing on external monitors that support color spaces and gamma curves that follow the guidelines established by DCI (Digital Cinema Initiatives).
[ACESproxy10]	ACESproxy10	ACES	LUT for viewing on external monitors compatible with the ACESproxy10 standard established by ACES (Academy Color Encoding System).
[Off]	–	–	No LUT applied.

i NOTES

- When you apply the [ACESproxy10] LUT to the REC OUT terminal, MON. terminal or HDMI OUT terminal, the selected terminal will output ACESproxy10 video data. Using a compatible monitor*, you can perform on-set color grading and check the image after color correction as you continue shooting (📖 24).
* When using the HDMI OUT terminal, a monitor that supports YCbCr Full Range quantization is required.
- If you set an assignable button to [LUT] (📖 131), you can press the button to turn on and off the LUTs applied to all output terminals/screens at once.
- If you change the [📷 Custom Picture] ➤ [Preset] or [📷 Custom Picture] ➤ [Main Settings] ➤ [Gamma] or [Color Space] settings, the LUT will be deactivated and all the terminals' output settings will be reset to [Off].

Superimposing Onscreen Displays on Screens/Video Outputs

You can choose to superimpose onscreen displays on the video output from the MON. terminal or HDMI OUT terminal. Doing so will display the onscreen displays on an external monitor. This setting will not affect your recordings or video output from the REC OUT terminal.

Operating modes: CAMERA MEDIA

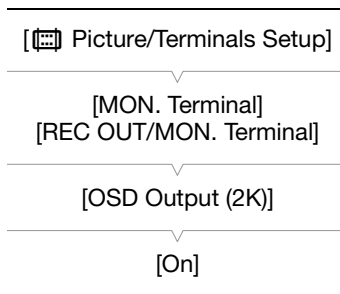

1 Open the [OSD Output (2K)] submenu.

[📷 Picture/Terminals Setup] ➤ [MON. Terminal] (CAMERA mode) or [REC OUT/MON. Terminal] (MEDIA mode) ➤ [OSD Output (2K)]

2 Select [On] and then press SET.

- In CAMERA mode, **DISP** appears on the right of the screen (only if [📷 Picture/Terminals Setup] ➤ [Custom Display 2] ➤ [OSD Output] is set to [On]). In MEDIA mode, the icon appears at the top of the screen in the playback screen.

i NOTES

- In CAMERA mode, when [📷 Recording/Media Setup] ➤ [REC OUT 4K RAW Mode] is set to [4K RAW] and [📷 Picture/Terminals Setup] ➤ [MON. Terminal] ➤ [Output] is set to [4K RAW Priority], onscreen displays will not be output.
- If you set an assignable button to [OSD Output (2K)] (📖 131), you can press the button to turn on and off the superimposing of onscreen displays on video output.

Audio Output

The camera can output audio from the REC OUT terminal, MON. terminal, HDMI OUT terminal or  (headphone) terminal. You can select which two channels of the 4 audio channels recorded with the clip will be output from the terminals*.

* For audio output from the REC OUT terminal or MON. terminal, only during 4K RAW video output.

Audio output configuration

Recorded audio configuration		Audio output while recording			Audio output during playback	
Audio compression	Audio bit depth	REC OUT / MON. terminal		HDMI OUT terminal	REC OUT / MON.terminal	HDMI OUT terminal
		4K RAW output	2K output			
4-channel linear PCM	24 bit	2-channel Linear PCM 16 bit	4-channel linear PCM 24 bit	2-channel Linear PCM 16 bit	4-channel linear PCM 24 bit	2-channel Linear PCM 16 bit
	16 bit		4-channel linear PCM 16 bit		4-channel linear PCM 16 bit	

Audio Output from the (headphone) Terminal



Operating modes: *

* Not available for audio output from the REC OUT and MON. terminals.

1 Open the audio channel selection submenu of the desired terminal.

[] Audio Setup] ➤ [Audio Output] ➤ [Monitor Channels] (headphones), [HDMI OUT Channels] (HDMI OUT terminal) or [4K RAW Channels] (REC OUT and MON. terminals**)

2 Select the desired option and then press SET.

- The audio channels selected for output from the  (headphone) terminal will appear on the right of the screen (only when [] Picture/Terminals Setup] ➤ [Custom Display 2] ➤ [Monitor Channels] is set to [On]).

** Only in mode when the terminal is set to 4K RAW output.

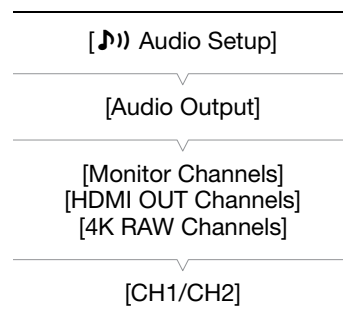

Options

Setting	Audio output	
	L	R
[CH1/CH2]	CH1	CH2
[CH1/CH1]	CH1	CH1
[CH2/CH2]	CH2	CH2
[CH1+2/CH1+2]	CH1+CH2 mixed	CH1+CH2 mixed
[CH3/CH4]	CH3	CH4
[CH3/CH3]	CH3	CH3
[CH4/CH4]	CH4	CH4
[CH3+4/CH3+4]	CH3+CH4 mixed	CH3+CH4 mixed
[CH1+3/CH2+4]	CH1+CH3 mixed	CH2+CH4 mixed

NOTES

- If you set an assignable button to [Monitor Channels] ( 131), you can press the button to toggle between the audio channel output options.

Saving Clips to a Computer

Use Canon XF Utility for XF-AVC to save and organize clips on a computer. Canon XF Utility for XF-AVC is available as a free download from your local Canon Web site. Refer to the Web site for the system requirements and the latest information about the software and supported non-linear editing (NLE) software.

Canon XF Utility for XF-AVC (Windows or Mac OS): Browser for transferring clips to a computer, playing back and checking video, and managing clips.

For details about using the software, refer to the instruction manual (PDF file) that is installed with the software. Refer to *Viewing the Software Instruction Manuals* (📖 171) for details on accessing the manuals. The following procedures for Windows systems are written based on a computer running Windows 7. The procedure may be different for other versions. For details see the Help modules of the operating system.

Operating modes:

Installing Canon XF Utility for XF-AVC (Windows)

An Internet connection is required to install the software.

- 1 Double-click the file that you downloaded from the Canon Web site to decompress it.
 - The file is **xuw*****.zip**
 - The folder **xuw******* will be created that contains the file **xuw***.exe**.
- 2 Double-click **xuw***.exe**.
- 3 Follow the onscreen instructions to select your area (continent), country/region and/or language, as necessary.
 - Available options will vary depending on your country/region.
- 4 After the message appears prompting you to close all other applications, exit other applications and then click **OK**.
 - The software's license agreement appears.
- 5 Read the license agreement and click **Yes** to continue.
 - If you do not select **Yes**, you cannot install the software.
- 6 Read the disclaimers regarding downloaded software and click **Yes** to begin the installation.
 - When the installation has completed, **Installation has completed successfully** appears.
- 7 Click **Next** and then click **Finish**.

Uninstalling the Software (Windows)

- 1 In the Control Panel, click on **Uninstall a program** (under **Programs**) or **Programs and Features**.
 - A list of installed programs appears.
- 2 Select the software you wish to uninstall.
 - Select from Canon XF Utility for XF-AVC or Canon XF-AVC Decoder*.
- 3 Click **Uninstall/Change** and follow the instructions.

* Uninstall the decoder only when completely uninstalling all of the software. An Internet connection is required to re-install it.

Installing Canon XF Utility for XF-AVC (Mac OS)

An Internet connection is required to install the software.

- 1 Double-click the file that you downloaded from the Canon Web site to decompress it.
 - The downloaded file is **xum****.dmg.gz**
 - The file **xum****.dmg** will be created.
- 2 Double-click **xum****.dmg**.
 - The **xum***** icon will appear on the desktop.
- 3 Double-click **xum***** and then double-click **XUMInstaller**.
- 4 Follow the onscreen instructions to select your area (continent), country/region and/or language, as necessary.
 - Available options will vary depending on your country/region.
- 5 After the message appears prompting you to close all other applications, exit other applications and then click **OK**.
 - The software's license agreement appears.
- 6 Read the license agreement and click **Yes** to begin the installation.
 - If you do not select **Yes**, you cannot install the software.
 - When the installation has completed, **Installation has completed successfully** appears.
- 7 Click **Next** and then click **Finish**.

Uninstalling the Software (Mac OS)

Drag and drop to **Trash** the file or folder corresponding to the item you wish to uninstall.

Software	File/Folder
Canon XF Utility for XF-AVC	/Applications/Canon Utilities/Canon XF Utility for XF-AVC
Canon XF-AVC Decoder	/Library/Application Support/Canon/XFUtility2/mc_bc_dec_avc.framework

Viewing the Software Instruction Manuals

The instruction manuals are installed with the software. Use the following procedures to view the software instruction manual.

The following procedures for Windows systems are written based on a computer running Windows 7. The procedures may be different for other versions. For details see the Help modules of the operating system.

Viewing the Canon XF Utility for XF-AVC Instruction Manual

Windows:

- 1 From the **Start** menu, select **All Programs > Canon Utilities > Canon XF Utility for XF-AVC**.
- 2 Click on the PDF file in the desired language to view the instruction manual.

Mac OS:

- 1 From **Applications**, open **Canon Utilities > Canon XF Utility for XF-AVC > Manual**.
- 2 Open the folder of the desired language and double-click the PDF file.

NOTES

- You can also view the instruction manual when the XF Utility for XF-AVC software is already running, by selecting **Help > View Instruction Manual** from the software's menu.

Developing RAW Clips

Use the Cinema RAW Development software to develop RAW clips recorded on an external recorder connected to the camera's REC OUT terminal or MON. terminal. After you develop the clips and export them to a full-quality standard file type such as DPX, they will be ready for color grading. Visit your local Canon Web site to download the software and check the system requirements and latest information on it. Refer to the instruction manual (PDF file) included with the software for details on its use.

The following procedures for Windows systems are written based on a computer running Windows 7. The procedure may be different for other versions. For details see the Help modules of the operating system.

Operating modes:

Installing Cinema RAW Development (Windows)

- 1 Double-click **crdw*****.zip**, the file that you downloaded from the Canon Web site to decompress it.
 - The folder **crdw******* will be created that contains the file **crdw***.exe**.
- 2 Follow the onscreen instructions to select your area (continent), country/region and/or language, as necessary.
 - Available options will vary depending on your country/region.
- 3 After the message appears prompting you to close all other applications, exit other applications and then click **OK**.
 - The software's license agreement appears.
- 4 Read the license agreement and click **Yes** to begin the installation.
 - If you do not select **Yes**, you cannot install the software.
 - When the installation has completed, **Installation has completed successfully** appears.
- 5 Click **Next** and then click **Finish**.

Uninstalling Cinema RAW Development

- 1 From the **Start** menu, select **All Programs > Canon Utilities > Cinema RAW Development > Uninstall Cinema RAW Development**.
 - A confirmation screen appears.
- 2 Click **OK** to begin uninstalling the software.
 - When the software has been uninstalled, **The software has been successfully uninstalled** appears.
- 3 Click **OK**.

Installing Cinema RAW Development (Mac OS)

- 1 Double-click **crdm*****.dmg.gz**, the file that you downloaded from the Canon Web site to decompress it.
 - The file **crdm*****.dmg** will be created.
- 2 Double-click **crdm*****.dmg**.
 - The **crdm***** icon will appear on the desktop.
- 3 Double-click **crdm***** and then double-click **CRDInstaller**.

- 4 Follow the onscreen instructions to select your area (continent), country/region and/or language, as necessary.
 - Available options will vary depending on your country/region.
- 5 After the message appears prompting you to close all other applications, exit other applications and then click **OK**.
 - The software's license agreement appears.
- 6 Read the license agreement and click **Yes** to begin the installation.
 - If you do not select **Yes**, you cannot install the software.
 - When the installation has completed, **Installation has completed successfully** appears.
- 7 Click **Next** and then click **Finish**.

Uninstalling Cinema RAW Development

- 1 From **Applications**, open **Canon Utilities**.
- 2 Move **Cinema RAW Development** to **Trash**.

Viewing the Software Instruction Manual

The instruction manual is installed with the software. Use the following procedures to view the software instruction manual.

Windows:

- 1 From the **Start** menu, select **All Programs > Canon Utilities > Cinema RAW Development**.
- 2 Click on the PDF file in the desired language to view the instruction manual.

Mac OS:

- 1 From **Applications**, open **Canon Utilities > Cinema RAW Development > Manual**.
- 2 Open the folder of the desired language and double-click the PDF file.

NOTES

- You can also view the instruction manual when the Cinema RAW Development software is already running, by selecting **Help > View Instruction Manual** from the software's menu.

Taking Photos

You can take photos when the camera is in **CAMERA** mode or you can grab still frames from a clip and save them as JPEG images when the camera is in **MEDIA** mode. Photos and still frames are saved onto the SD card and their size depends on the video configuration currently in use.

Resolution currently in use/Resolution of the clip being played back	Photo/Still frame size	Approximate file size per image
4096x2160, 2048x1080	2048x1080	930 KB
3840x2160, 1920x1080	1920x1080	880 KB

Taking Photos in CAMERA Mode

To take a photo, set an assignable button to [Photo] in advance.

Operating modes: **CAMERA** **MEDIA**

- 1 Set an assignable button to [Photo] (📖 131).
- 2 When the camera is in record standby mode, press the assignable button to take a photo.
 -  and the number of available photos appear on the upper right of the screen.
 - The SD card access indicator will illuminate in red as the photo is being recorded.



NOTES

- Photos cannot be taken during pre-recording mode.

Grabbing Still Frames in MEDIA Mode

To grab still frames from a clip, set an assignable button to [Photo] in advance.

Operating modes: **CAMERA** **MEDIA**

- 1 Set an assignable button to [Photo] (📖 131).
- 2 Select the desired clip and press the  button to start playback.
- 3 Pause the playback at the frame you want to grab and save as an image file.
- 4 Press the assignable button to grab the still frame.
 -  and the number of available photos appear on the upper right of the screen.
 - The SD card access indicator will illuminate in red as the still frame is being recorded.
- 5 Press the  button to stop playback.

! IMPORTANT

- Observe the following precautions while the SD card access indicator is illuminated in red. Failure to do so may result in permanent data loss.
 - Do not disconnect the power source or turn off the camera.
 - Do not remove the SD card.

i NOTES

- If the LOCK switch on the SD card is set to prevent writing, you will not be able to record photos or grab frames. Change the position of the LOCK switch in advance.

Photo Numbering

Photos are automatically assigned consecutive numbers and stored on the SD card in folders. You can select the photo numbering method to be used.

Operating modes: CAMERA MEDIA

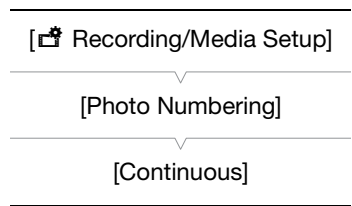

1 Open the [Photo Numbering] submenu.

[Recording/Media Setup] ➤ [Photo Numbering]

2 Select the desired option and the press SET.

Options

- [Reset]: Photo numbers will restart from 100-0001 every time you insert a new SD card. If an SD card already contains previous recordings, photo numbers will continue from the number following that of the last photo on the SD card.
- [Continuous]: Photo numbers will continue from the number following that of the last photo recorded with the camera. This setting is the most convenient for managing files on a computer. We recommend using the [Continuous] setting.

Understanding folder names

- An example folder name is “101_1103”. The first 3 digits indicate the folder number (from 100 to 999) and the last 4 digits indicate the month and day when the folder was created. In the example, the folder numbered 101 was created on November 3.

Understanding photo numbers

- An example photo number is “101-0107”. The first 3 digits indicate the folder number where the photo is stored and the last 4 digits indicate the consecutive number assigned to the photo (from 0001 to 9999).
- The photo number also indicates the name and location of the file on the SD card. For example, a photo numbered 101-0107 that was recorded on November 3, is located in the “DCIM\101_1103” folder as the file “IMG_0107.JPG”.

i NOTES

- Each folder can contain up to 500 files. When that number is exceeded, a new folder is created automatically.

Photo Playback

You can view the photos that you took with the camera.

Operating modes: CAMERA MEDIA

Displaying the [Photos] Index Screen

Display the [Photos] index screen to view photos.

- 1 Set the **POWER** switch to **MEDIA**.
 - The camera switches to MEDIA mode and the clip index screen appears.
- 2 Press the **INDEX** button.
 - The index screen selection menu appears.
- 3 Select **[Photo Index]** and then press **SET**.
 - The [Photos] index screen appears.
 - When you have finished viewing photos, press the **INDEX** button to return to the clip index screen.

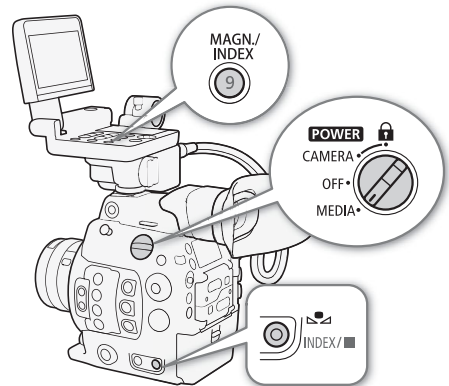

Viewing Photos

- 1 Move the orange selection frame to the desired photo.
- 2 Press the **▶/||** button to view the photo.
 - The photo playback screen appears and the selected photo is displayed.
 - Use the **◀◀/▶▶** buttons or push the joystick left/right to switch to the previous/next photo.
 - Press the **DISP.** button on the monitor unit or an assignable button set to **[Display]** (📖 131) to hide/show the onscreen displays.
 - Press the **■** button to return to the [Photos] index screen.

! IMPORTANT

- Observe the following precautions while the SD card access indicator is illuminated in red. Failure to do so may result in permanent data loss.
 - Do not disconnect the power source or turn off the camera.
 - Do not remove the SD card.

i NOTES

- The following photos may not be displayed correctly.
 - Photos not recorded with this camera.
 - Image files that were created, edited or renamed using a computer.

Media Server: Viewing Photos on a Connected Wi-Fi Device

After connecting the optional WFT-E6 Wireless File Transmitter and completing the registration of a Wi-Fi access point, you can use the camera's Media Server function to wirelessly access the photos on the SD card in the camera from a connected Wi-Fi device. Refer also to the instruction manuals for the computer/device, software and access point used.

Operating modes: CAMERA MEDIA

Preparations

To be able to access the camera remotely via Wi-Fi, you will need to attach an optional WFT-E6 Wireless File Transmitter to the camera's system extension terminal, complete the Wi-Fi network setup, and select an access point (infrastructure connection). Download the 'WFT-E6: Guide for EOS C300 Mark II Users' (PDF file) from your local Canon Web site and follow the instructions to complete the necessary steps.

- 1 Camera: Open the [Media Server] submenu and then press SET to activate the function.
[📷 System Setup] ➤ [Network Settings] ➤ [Media Server]
- 2 Connected device: Start your preferred media player software/application and select the camera's model name from the list of media servers.
- 3 Connected device: Select the folder corresponding to the camera's SD card and play back the photos.
- 4 Camera: When you have finished playing back, press SET to end the media server mode.

Deleting Photos

You can delete a photo you no longer need. Photos can be deleted one at a time from the photo playback screen or all photos at once from [Photos] index screen.

Operating modes: CAMERA MEDIA

Deleting a Single Photo

The basic operation of the photo menu is identical to that of the clip menu (153).

- 1 Select the photo you wish to delete.
 - Display the desired photo (177) or open the [Photos] index screen and move the orange selection frame to the desired photo.
- 2 Press SET to open the photo menu.
- 3 Select [Delete] and then press SET.
 - The screen prompts you to confirm the operation.
- 4 Select [OK] and then press SET.
 - Select [Cancel] instead to cancel the operation.
 - The selected photo is deleted.
- 5 When the confirmation message appears, press SET.

Deleting All Photos

- 1 Open the [Delete All Photos] submenu.
 - [Recording/Media Setup] ▶ [Delete All Photos]
- 2 Select [OK] and then press SET.
 - All the photos on the SD card will be deleted.
 - Select [Cancel] instead to cancel the operation.
 - While the photos are being deleted, you can press SET to cancel.
- 3 When the confirmation message appears, press SET.

[Recording/Media Setup]

[Delete All Photos]

! IMPORTANT

- Be careful when deleting photos. Deleted photos cannot be recovered.

Menu Options

For details about how to select an item, refer to *Using the Menus* (📖 32). For details about each function, see the reference page. Menu items without a reference page are explained after the tables. Setting options in boldface indicate default values.

Depending on the camera's operating mode and the settings, some menu items may not be available. Such menu items do not appear or appear grayed out in menu screens.

To skip directly to the page of a specific menu:

[📷 Camera Setup] menu	📖 181
[🖼️ Custom Picture] menu	📖 182
[🎵 Audio Setup] menu	📖 183
[📹 Recording/Media Setup] menu	📖 183
[🖥️ Picture/Terminals Setup] menu	📖 185
[🛠️ Assistance Functions] menu	📖 187
[👤 System Setup] menu	📖 188
[★ My Menu 1] customized menu	📖 190

[📷 Camera Setup] menu (CAMERA mode only)

Menu item	Submenu	Setting options	📖
[Light Metering]		[Backlight], [Standard], [Spotlight]	73
[AE]	[AE Shift]	[+2.0], [+1.75], [+1.5], [+1.25], [+1.0], [+0.75], [+0.5], [+0.25], [±0], [-0.25], [-0.5], [-0.75], [-1.0], [-1.25], [-1.5], [-1.75], [-2.0]	72
	[AE Response]	[High], [Normal], [Low]	71
[ISO/Gain]	[Select]	[ISO], [Gain]	67
	[Extended Range]	[On], [Off]	
	[ISO Increment]	[1 stop], [1/3 stop]	
	[Gain Increment]	[Normal], [Fine]	
[Iris]	[Mode]*	[Automatic], [Manual]	70
	[Iris Increment]	[1/2 stop], [1/3 stop], [Fine]	
	[Iris Indicator]	[F], [⏏]	
	[Zoom-Iris Correct.]	[On], [Off]	
[Extended ND Range]		[On], [Off]	69
[Shutter]	[Mode]	[Speed], [Angle], [Clear Scan], [Slow], [Off]	65
	[Shutter Increment]	[1/3 stop], [1/4 stop]	
[White Balance]	[Shockless WB]	[On], [Off]	74
	[AWB Response]	[High], [Normal], [Low]	76
[Focus]	[AF Mode]	[One Shot], [AF-Boosted MF], [Continuous]	77
	[AF Frame Position]	[Selectable], [Center Frame]	83
	[AF Frame Size]	[Large], [Small]	
	[Face Det. & Tracking]	[On], [Off]	84
	[Face AF]	[Face Priority], [Face Only]	84
	[AF Speed]	-7 to +2 (0)	82
	[Apply AF Speed Limit]	[Always], [Only While Recording]	
	[AF Response]	+3 to -3 (0)	

Menu item	Submenu	Setting options	
[ABB]		[Cancel], [OK]	52
[Color Bars]	[Activate]	[On], [Off]	102
	[Type]	[SMPTE] , [EBU]** , [ARIB]	
[Periph. Illum. Corr.]		[On], [Off]	37
[Chromatic Aberr. Corr.]		[On], [Off]	



* Available only with compatible EF lenses ( 213).

**The default value depends on the country/region or purchase.

[Iris Indicator]: Determines whether the aperture value will be displayed on the screen and rear panel in terms of F values or T values (only when using a Canon Cinema lens).

[Zoom-Iris Correct.]: If you are using a compatible lens, when this setting is set to [On], the camera will adjust the aperture as needed to keep the selected aperture value while zooming. Because of this adjustment, the brightness of the image might change slightly or you may hear the operation sound.

[CP Custom Picture] menu ( mode only)

Menu item	Submenu	Setting options	
[Preset]		[Canon Log 2: C.Gamut], [Canon Log 2: BT.2020], [Canon Log 2: DCI-P3], [Canon Log 2: BT.709], [Canon Log], [BT.2020], [BT.709] , [Off]	134
[Main Settings]	[Gamma]	[Canon Log 2], [Canon Log], [Wide DR] , [EOS Standard], [Normal 1 (Standard)], [Normal 2 (x4.0)], [Normal 3 (BT.709)], [Normal 4 (x5.0)]	138
	[Color Space]	[Cinema Gamut], [BT.2020 Gamut], [DCI-P3 Gamut], [BT.709 Gamut]	
	[Color Matrix]	[Neutral] , [Production Camera], [Cinema EOS Original], [Video], [EOS Standard], [Off]	
[Other Settings]		See detailed explanations on the reference pages.	139 -
[File]	[Select]	[C1:CP000001] to [C20:CP0000020]	134
	[Rename]	–	136
	[Protect]	[Protect], [Unprotect]	136
	[Reset]	[Cancel], [OK]	136
	[Transfer]	[Copy to ], [Load from ]	137

[🔊] Audio Setup] menu

Menu item	Submenu	Setting options	📖
[Audio Input]	[Audio Bit Depth]	[24 bit] , [16 bit]	96
	[CH2 Input]	[INPUT 2] , [INPUT 1]	98
	[INPUT 1 Mic Trimming]	[+12 dB], [+6 dB], [0 dB] , [-6 dB], [-12 dB]	99
	[INPUT 1 Mic Att.]	[On], [Off]	100
	[INPUT 2 Mic Trimming]	[+12 dB], [+6 dB], [0 dB] , [-6 dB], [-12 dB]	99
	[INPUT 2 Mic Att.]	[On], [Off]	100
	[INPUT 1&2 ALC Link]	[Linked], [Separated]	99
	[INPUT 1&2 Limiter]	[On], [Off]	99
	[MIC Mode]	[Automatic] , [Manual]	100
	[MIC Level]	0 to 99 (50)	
	[MIC Att.]	[On], [Off]	101
	[MIC Low Cut]	[On], [Off]	100
	[1 kHz Tone]	[-12 dB], [-18 dB], [-20 dB], [Off]	102
[Audio Output]	[Headphone Volume]	[Off], 1 to 15 (8)	151
	[Monitor Channels]	[CH1/CH2] , [CH1/CH1], [CH2/CH2], [CH1+2/CH1+2], [CH3/CH4], [CH3/CH3], [CH4/CH4], [CH3+4/CH3+4], [CH1+3/CH2+4]	169
	[HDMI OUT Channels]	[CH1/CH2] , [CH3/CH4]	169
	[4K RAW Channels]	[CH1/CH2] , [CH3/CH4]	

[📷] Recording/Media Setup] menu

Menu item	Submenu	Setting options	📖
[Initialize Media]	[CFast A], [CFast B]	[Cancel], [OK]	49
	[SD Card]	[Complete], [Quick]	
[System Frequency]		[59.94 Hz] , [50.00 Hz]* , [24.00 Hz]	62
[REC OUT 4K RAW Mode]		[4K RAW], [2K] , [Off]	164
[4K RAW Color Space]		[BT.2020 Gamut], [Cinema Gamut]	164
[Recording Mode]		[Normal Recording] , [Slow & Fast Motion], [Slow & Fast Motion (crop)], [Pre-Recording], [Frame Recording], [Interval Recording]	113
[Frame Rate]		When [System Frequency] is set to [59.94 Hz]: [59.94i], [59.94P], [29.97P] , [23.98P] When [System Frequency] is set to [50.00 Hz]: [50.00i], [50.00P], [25.00P]	62
[Resolution/Color Sampling]		[4096x2160 YCC422 10 bit], [3840x2160 YCC422 10 bit] , [2048x1080 YCC422 10 bit], [1920x1080 YCC422 10 bit], [2048x1080 RGB444 12 bit], [1920x1080 RGB444 12 bit], [2048x1080 RGB444 10 bit], [1920x1080 RGB444 10 bit]	62
[Bit Rate]		[310 Mbps Intra-frame], [160 Mbps Intra-frame], [50 Mbps Long GOP]	63

Menu item	Submenu	Setting options	
[Special Recording Settings]	[S&F Frame Rate]	When [System Frequency] is set to [59.94 Hz] or [24.00 Hz]: 4K: 1 to 30 , 2K: 1 to 60** (30) ** 1 to 120 when slow & fast motion in crop mode is selected. When [System Frequency] is set to [50.00 Hz]: 4K: 1 to 25 , 2K: 1 to 50*** (25) *** 1 to 100 when slow & fast motion in crop mode is selected.	113
	[Frame Recording]		116
	[Recorded Frames]	1, 3, 6, 9	
	[Interval Recording]		117
	[Interval]	[1 sec], [2 sec], [3 sec], [5 sec], [10 sec], [15 sec], [30 sec], [1 min], [2 min], [3 min], [5 min], [10 min]	
	[Recorded Frames]	1, 3, 6, 9	
[XF-AVC Proxy Recording]	[Activate]	[On], [Off]	111
	[Apply LUT]	[BT.709], [BT.2020], [DCI], [Off]	
[Relay/Double Slot Rec]	[Relay Recording]	[On], [Off]	50
	[Double Slot Recording]	[On], [Off]	
[Metadata]	[Camera Index]	[A] to [Z], [Set]	59
	[Reel Number]	[001] to [999], [Set], [Reset]	
	[Clip Number]	[001] to [999], [Set], [Reset]	
	[User Defined]	[CANON] , [Set], 5 characters, each: [A] to [Z], [0] to [9]	
	[Scene]	[Set], [Reset], 16 characters, each: [] (space), [A] to [Z], [0] to [9], [+], [-], [:]	107
	[Take]	[Set], [Reset], 8 characters, each: [] (space), [A] to [Z], [0] to [9], [+], [-], [:]	
	[Setting]	[Remote], [SD Card]	106, 128
	[User Memo]	[Off] , list of user memo files available on the SD card	106
	[Country Code]	[Set], 4 characters, each: [] (space), [A] to [Z], [0] to [9], [+], [-], [:]	-
	[Organization]	The default setting for [Organization] only is [00_] .	
	[User Code]		
	[Add CP File]	[On] , [Off]	137
[Rec Command]		[On] , [Off]	-
[HDMI Time Code]		[On], [Off]	166
[Clips]	[Copy All Clips]	[Cancel], [OK]	155
	[Copy OK Clips]		
	[Delete All Clips]		156
[Photo Numbering]		[Reset], [Continuous]	176
[Delete All OK Marks]		[Cancel], [OK]	155
[Delete All Photos]			179

* The default value depends on the country/region or purchase.

[Country Code] (CAMERA mode only): This identifier is the country code defined by ISO-3166-1 and is to be entered starting from the left.

[Organization] (CAMERA mode only): This identifier represents the organization that owns or operates the camera and can be obtained by registering with the SMPTE Registration Authority. If the organization is not registered, enter [0000].

[User Code] (CAMERA mode only): This identifier designates the user. Leave this blank if [Organization] is set to [0000].

[Rec Command] (CAMERA mode only): When you connect the camera to an external recorder, if you start or stop recording with the camera, the other device will also start or stop recording.

- To output the recording command from the HDMI OUT terminal, you need to set both [Rec Command] to [On] and also [Recording/Media Setup] [HDMI Time Code] to [On] to output simultaneously the time code and recording command.

[Picture/Terminals Setup] menu

Menu item	Submenu	Setting options	
[Select Monitoring Devices]		[MON.+HDMI+LCD(VF)], [MON.+HDMI+VF], [LCD+VF]	–
CAMERA mode: [MON. Terminal] MEDIA mode: [REC OUT/MON. Terminal]	[Output]	CAMERA mode: [4K RAW Priority], [2048x1080/1920x1080], [1920x1080], [Off] MEDIA mode: [2048x1080/1920x1080], [1920x1080], [Off]	164
	[OSD Output (2K)]	[On], [Off]	168
[3G-SDI Mapping]		[Level A], [Level B]	164
[GENLOCK/SYNC OUT Term.]	[Select]	[HD Sync Output], [Genlock Input]	93, 95
	[Genlock Adjustment]	–1023 to +1023 (000), [Set]	93
	[SYNC Scan Mode]	[P], [PsF]	95
[Time Code]	[Mode]	[Preset], [Regen.]	88
	[Run]	[Rec Run], [Free Run]	88
	[DF/NDF]	[DF], [NDF]	89
	[Setting]	[00:00:00:00] to [23:59:59:29], [Set], [Reset]	89
	[TC In/Out]	[In], [Out]	93, 95
[User Bit]	[Recording Mode]	[Internal], [External]	94
	[Type]	[Setting], [Time], [Date]	91
[LCD Setup]	[Brightness]	–99 to 99 (±0)	41
	[Contrast]	–99 to 99 (±0)	
	[Color]	–20 to 20 (±0)	
	[Sharpness]	1 to 4 (2)	
	[Backlight]	[Normal], [+1], [+2]	
[Viewfinder Setup]	[Brightness]	–99 to 99 (±0)	41
	[Contrast]	–99 to 99 (±0)	
	[Color]	–20 to 20 (±0)	
	[Sharpness]	1 to 4 (2)	
	[Luminance]	[Normal], [High]	
	[Eye Sensor]	[On], [Off]	
[Panel Luminance]		1 to 5 (3)	–
[DISP. Button Levels]	[All Displays]	[On], [Off]	58
	[Surrounding Icons]	[On], [Off]	
	[Markers]	[On], [Off]	
	[No Displays]	[On], [Off]	

Menu item	Submenu	Setting options	
[Custom Display 1]	[Light Metering]	[On], [Off]	55, 145
	[Custom Picture]	[On], [Off]	
	[Focal Length]	[On], [Off]	
	[ND Filter]	[On], [Off]	
	[Focus Mode]	[On], [Off]	
	[Key Lock]	[On], [Off]	
	[White Balance]	[On], [Off]	
	[Exposure]	[On], [Off]	
	[Iris]	[On], [Off]	
	[ISO/Gain]	[On], [Off]	
	[Shutter]	[On], [Off]	
	[Peaking]	[On], [Off]	
	[Magnification]	[On], [Off]	
	[LUT]	[On], [Off]	
[Lens]	[On], [Off]		
[Custom Display 2]	[Remaining Battery]	[Only Warnings], [Normal], [Off]	55, 145
	[Remaining Rec Time]	[Only Warnings], [Normal], [Off]	
	[Recording Mode]	[On], [Off]	
	[Genlock]	[On], [Off]	
	[Time Code]	[On], [Off]	
	[Reel/Clip Number]	[On], [Off]	
	[Interval Counter]	[On], [Off]	
	[Remaining Photos]	[Only Warnings], [Normal], [Off]	
	[Temperature/Fan]	[On], [Off]	
	[Resolution/Color Sampling]	[On], [Off]	
	[Frame Rate]	[On], [Off]	
	[OSD Recording]	[On], [Off]	
	[Output Terminals Status]	[On], [Off]	
	[OSD Output]	[On], [Off]	
	[Rec Command]	[On], [Off]	
	[User Memo]	[On], [Off]	
	[User Bit]	[On], [Off]	
	[Monitor Channels]	[On], [Off]	
	[Audio Level]	[On], [Off]	
	[Network Functions]	[On], [Off]	
[GPS]	[On], [Off]		
[Date/Time]	[Date/Time], [Time], [Date], [Off]		
[Custom Display]	[Audio Level]	[On], [Off]	-
	[Date/Time]	[On], [Off]	
	[Camera Data]	[On], [Off]	

[Select Monitoring Devices] (CAMERA mode only): Determines the combination of screens and video outputs (for external monitors) that will be used to display the camera's picture in CAMERA mode. [LCD] is the LCD screen on the monitor unit, [VF] is the viewfinder on the camera, [MON.] is the MON. terminal, [HDMI] is the HDMI OUT terminal.

- When this setting is set to [MON.+HDMI+LCD(VF)], the LCD screen and viewfinder cannot be used simultaneously.
- The REC OUT terminal can be used to monitor the camera's picture at all times (as long as [Recording/Media Setup] ➤ [REC OUT 4K RAW Mode] is set to a setting other than [Off]).
- In [MEDIA] mode, the playback picture will be displayed on all screens and output from all active terminals.

[Genlock Adjustment]: The phase difference between the external Genlock signal and the camera is initially set to 0. This function allows you to adjust it within the range of approx. ± 0.4 H (-1023 to 1023). When setting to 1000 or more or -1000 or less, set the first field to 10 or -10, respectively.

[Viewfinder Setup] ➤ [Eye Sensor]: When this setting is set to [On], the viewfinder will turn on automatically when it detects the user's eye near the eyepiece (as long as it is selected as a monitoring device). To keep the viewfinder permanently on (when it is selected as a monitoring device), set [Eye Sensor] to [Off].

[Panel Luminance]: Selects the brightness of the rear panel out of 5 available levels.

[Custom Display] ([MEDIA] mode only): These settings determine whether certain onscreen displays will appear on the playback screen.

[Audio Level]: Displays the audio level meter (clip playback screen only).

[Date/Time]: Displays the date and time when the clip/photo was recorded.

[Camera Data]: Displays the shutter speed, aperture value and ISO speed/gain (clip playback screen only).

[Assistance Functions] menu

Menu item	Submenu	Setting options	
[Focus Guide]		[On], [Off]	79
[Peaking]	[Activate]	[On], [Off]	79
	[Display on LCD]	[On], [Off]	
	[Display on VF]	[On], [Off]	
	[Output to MON. & HDMI]	[On], [Off]	
	[Select]	[Peaking 1], [Peaking 2]	
	[Peaking 1]		
	[Color]	[White], [Red], [Yellow], [Blue]	
	[Gain]	[Off], 1 to 15 (8)	
	[Frequency]	1 to 4 (2)	
	[Peaking 2]		
[Color]	[White], [Red], [Yellow], [Blue]		
[Gain]	[Off], 1 to 15 (15)		
[Frequency]	1 to 4 (1)		
[Focus Assistance B&W]	[On], [Off]		
[Zebra]	[Activate]	[On], [Off]	87
	[Display on LCD]	[On], [Off]	
	[Display on VF]	[On], [Off]	
	[Output to MON. & HDMI]	[On], [Off]	
	[Select]	[Zebra 1], [Zebra 2], [Zebra 1&2]	
	[Zebra 1 Level]	[70 ±5%], [75 ±5%], [80 ±5%], [85 ±5%], [90 ±5%], [95 ±5%]	
	[Zebra 2 Level]	[70%], [75%], [80%], [85%], [90%], [95%], [100%]	
[Magnification]	[Display on LCD]	[On], [Off]	79
	[Display on VF]	[On], [Off]	
	[Output to MON. & HDMI]	[On], [Off]	
	[Focus Assistance B&W]	[On], [Off]	

Menu item	Submenu	Setting options	
[Markers]	[Activate]	[On], [Off]	86
	[Center]	[Black], [Gray], [White], [Off]	
	[Horizontal]	[Black], [Gray], [White], [Off]	
	[Grid]	[Black], [Gray], [White], [Off]	
	[Aspect Marker]	[Black], [Gray], [White], [Off]	
	[Aspect Ratio]	[4:3], [13:9], [14:9], [16:9], [1.375:1], [1.66:1], [1.75:1], [1.85:1], [1.90:1], [2.35:1], [2.39:1] , [Custom]	
	[Custom Aspect Ratio]	1.00:1 to 9.99:1 (1.00:1)	
	[Safe Area]	[Black], [Gray], [White], [Off]	
	[Basis for Safe Area]	[Whole Picture] , [Selected Aspect Marker]	
	[Percentage of Safe Area]	[80%], [90%], [92.5%], [95%]	
[LUT]	[Activate]	[On], [Off]	167
	[MON. & HDMI (2K)]	[BT.709], [BT.2020], [DCI], [ACESproxy10], [Off]	
	[REC OUT (2K)]		
	[LCD & VF]	[BT.709], [Off]	
[B&W Image]	[Activate]	[On], [Off]	42
	[Display on LCD]	[On] , [Off]	
	[Display on VF]	[On] , [Off]	
	[Output to MON. & HDMI]	[On] , [Off]	
[WFM]	[Activate]	[On], [Off]	103
	[Output]	[LCD], [VF], [MON. & HDMI], [All]	
	[Waveform Monitor]		103
	[Type]	[Line] , [Line+Spot], [Select Line], [Field], [RGB], [YPbPr]	
	[Gain]	[1x] , [2x]	
	[Y Position]	[0%] , [15%], [30%], [45%], [50%]	
	[Select Line]	When the vertical resolution is 1080: 0 to 1079 (540) in 1-line increments, [Set] When the vertical resolution is 2160: 0 to 2158 (1080) in 2-line increments, [Set]	

[🔧 System Setup] menu

Menu item	Submenu	Setting options	
[Reset]	[All Settings]	[Cancel], [OK]	-
	[Camera Settings]	[Cancel], [OK]	
	[Assignable Buttons]	[Cancel], [OK]	
[Transfer Menu/CP]	[Save]	[To Camera], [To <small>SD</small>]	146
	[Load]	[From Camera], [From <small>SD</small>]	
[Time Zone]		List of world time zones. [UTC-05:00 New York] or [UTC+01:00 Central Europe] ¹	30
[Set Clock]	[Date/Time]	-	31
	[Date Format]	[YMD], [YMD/24H], [MDY] , [MDY/24H], [DMY] , [DMY/24H] ¹	
[Language 🗣️]		[Deutsch], [English] , [Español], [Français], [Italiano], [Polski], [Português], [Русский], [简体中文], [한국어], [日本語]	31
[REMOTE Term.]		[RC-V100], [Standard]	119

Menu item	Submenu	Setting options	
[Assignable Buttons]	[Camera]	See footnote 3	131
	[1] to [11]		
	[Grip]		
	[1]		
	[Monitor]		
	[1] to [10] ²		
	[Remote Controller]		
	[1] to [4]		
[Tally Lamp]		[On], [Off]	–
[Media Access LED]		[On], [Off]	–
[Fan]	[Mode]	[Automatic], [Always On]	61
	[Fan Speed (STBY)]	[Maximum], [High], [Middle], [Low]	
	[Fan Speed (REC)]	[High], [Middle], [Low]	
	[Fan Speed (Always)]	[High], [Middle], [Low]	
[Fan Speed]		[High], [Middle], [Low]	61
[Review Recording]		[Entire Clip], [Last 4 sec]	110
[Custom Function]	[Camera Control Dial]	[Iris], [ISO/Gain], [Off]	144
	[Grip Control Dial]		
	[Camera Control Dial Dir.]	[Reverse], [Normal]	
	[Grip Control Dial Dir.]		
	[SELECT Dial Dir.]	[Reverse], [Normal]	
	[Retract Lens]	[On], [Off]	
	[3D Rec Mode]	[On], [Off]	
	[Scan Reverse Rec]	[Both], [Vertical], [Horizontal], [Off]	
	[Displayed Units]	[Meters], [Feet] ²	
	[OSD Recording (CFast)]	[Time Code/Date/Time], [Date/Time], [Time Code], [Time], [Date], [Off]	
	[START/STOP Button]		
	[Camera]	[Disable], [Enable]	
	[Grip]		
	[Monitor]		
	[Key Lock]	[All Buttons], [Except For START/STOP]	
[Reset Hour Meter]		[Cancel], [OK]	–
[Network Settings] ⁴	[Browser Remote]		120
	[Activate]	[On], [Off]	
	[Camera ID] ⁵	–	
	[Port No.] ⁵		–
	[Users Settings] ⁵		
	[Media Server]	–	178
	[Connection Settings] ⁵	–	–
[GPS] ⁶	[Activate]	[On], [Off]	108
	[Auto Time Setting]	[On], [Off]	
[Certification Logos]		–	–
[Firmware]	[Camera]	–	–
	[Lens]		38

- ¹ The default value depends on the country/region or purchase.
 - ² Assignable buttons Monitor 1 to Monitor 6 are only available in **CAMERA** mode. In **MEDIA** mode, their function cannot be changed.
 - ³ Setting options for [Assignable Buttons]: [(NONE)], [One-Shot AF], [AF Lock], [Focus Guide], [Face AF], [Face Det. & Tracking], [Tracking], [Push Auto Iris], [Iris Mode], [Iris +], [Iris -], [ND +], [ND -], [AE Shift +], [AE Shift -], [Backlight], [Spotlight], [FUNC.], [Shutter], [ISO/Gain], [White Balance], [Peaking], [Zebra], [WFM], [Magnification], [Color Bars], [Markers], [LCD Setup], [Viewfinder Setup], [LUT], [OSD Output], [Display], [Add Shot Mark 1], [Add Shot Mark 2], [Add Mark], [Add Mark], [Time Code], [Time Code Hold], [Headphones +], [Headphones -], [Monitor Channels], [Audio Level], [Photo], [Review Recording], [S&F Frame Rate], [Status], [Custom Picture], [My Menu], [Initialize Media], [Index], [User Setting].
- The default settings are as follows. On the camera: 1: [Magnification], 2: [Peaking], 3: [Zebra], 4: [WFM], 5: [ISO/Gain], 6: [Shutter], 7: [S&F Frame Rate], 8: [(NONE)], 9: [FUNC.], 10: [Push Auto Iris], 11: [One-Shot AF]. On the grip: 1: [Focus Guide]. On the monitor unit: 1 to 6: [(NONE)], 7: [Display], 8: [WFM], 9: [Magnification] (**CAMERA** mode) or [Index] (**MEDIA** mode), 10: [FUNC.]. On the optional remote controller: 1: [Magnification], 2: [Peaking], 3: [Zebra], 4: [WFM].
- ⁴ Available only when the optional WFT-E6 Wireless File Transmitter is attached to the camera.
 - ⁵ For details refer to the 'WFT-E6: Guide for EOS C300 Mark II Users' (PDF file).
 - ⁶ Available only when the optional GP-E1 GPS Receiver is attached to the camera.

[Reset]: Reset various camera settings.

- [All Settings]: Resets all the camera's settings to default settings, except for the hour meter.
- [Camera Settings]: Resets the white balance, iris, ISO speed, gain, shutter speed, [Camera Setup] settings and custom picture settings to default settings.
- [Assignable Buttons]: Resets the assignable buttons to default settings.

[Tally Lamp]: Allows you to set whether the tally lamp illuminates while the camera is recording.

[Media Access LED]: Allows you to set whether the CFast card access indicators or the SD card access indicator illuminates while the camera is accessing a CFast card or SD card.

[Reset Hour Meter]: The camera has two "hour meters" – the first keeps track of total operation time and the second keeps track of operation time since the last time the second hour meter was reset with this function.

[Firmware] [Camera]: You can verify the current version of the camera's firmware. This menu option is usually unavailable.

[My Menu 1]* (**CAMERA** mode only)

Menu item	Submenu	Setting options	
[Select]		[1: CAMERA-1], [2: CAMERA-2], [3: CAMERA-3]	33
[Edit]	[Register]	[Cancel], [OK]	
	[Move]		
	[Delete]		
	[Reset All]		
	[Rename]	[Input], [OK]	

* Default setting. You can select a different My Menu set in advance.

Displaying the Status Screens

You can use the status screens to check the camera's various settings. You can also output the status screens to an external monitor.

Operating modes: CAMERA MEDIA

- 1 Set an assignable button to [Status] in advance (📖 131).
- 2 Press the assignable button to open the status screens.
 - The status screen most recently displayed will appear unless you turned off the camera or changed the operating mode. In such case, the [Gamma/Color Space/Color Matrix] status screen appears in CAMERA mode and the [Assignable Buttons 1/3] status screen appears in MEDIA mode.
- 3 Push the joystick up/down or turn the SELECT dial to scroll through the status screens.
- 4 When you have finished, press the assignable button set to [Status] again to exit the status screens.
 - Alternatively, you can press the CANCEL button.

In the following pages you can find more details about the information displayed on the status screens. When the optional WFT-E6 Wireless File Transmitter is attached to the camera, four [Network Settings] status screens will be displayed as well. For details about these status screens and all network settings, refer to the 'WFT-E6: Guide for EOS C300 Mark II Users' (PDF file).

[Gamma/Color Space/Color Matrix] screen	📖 191
[CP Data] screens	📖 192
[Camera] screens	📖 193
[Assignable Buttons] screens	📖 194
[Audio] screens	📖 195
[Media] screen	📖 195
[Video] screens	📖 196
[Metadata] screens	📖 197
[Battery/Hour Meter] screen	📖 197
[GPS Information Display] screen*	📖 198

* Only when the optional GP-E1 GPS Receiver is attached to the camera's system extension terminal.

[Gamma/Color Space/Color Matrix] Status Screen (CAMERA mode only)

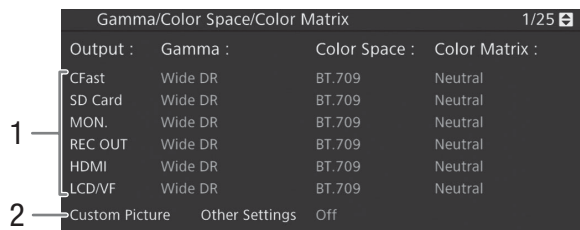

- 1 Gamma curve, color space and color matrix used for recordings, video output and displays
 - [CFast]: Settings used for primary clips recorded on the CFast card (📖 134, 138)
 - [SD Card]: Settings/LUT used for proxy clips recorded on the SD card (📖 111)
 - [MON.], [REC OUT], [HDMI]: Settings/LUT used for video output from the respective terminals (📖 167)
 - [LCD/VF]: Settings/LUT used for the camera's LCD screen and viewfinder (📖 167)
- 2 CP Custom Picture ➡ Other Settings ➡ [Activate] setting (whether detailed settings in the custom picture file are active or not)

[CP Data 1/3] Status Screen (CAMERA mode only)

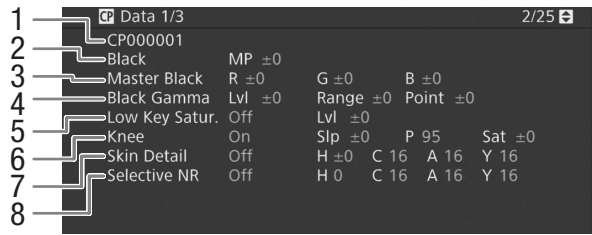

- | | |
|--|---|
| <ul style="list-style-type: none"> 1 Custom picture file name (📖 134) 2 Master pedestal (📖 139) 3 Master black RGB levels (📖 139) 4 Black gamma settings (level, range and point) (📖 139) 5 Low key saturation (📖 140) 6 Knee settings (slope, point and saturation) (📖 140) | <ul style="list-style-type: none"> 7 Skin detail settings (hue, chroma, area and Y level) (📖 141) 8 Selective NR settings (hue, chroma, area and Y level) (📖 142) |
|--|---|

[CP Data 2/3] Status Screen (CAMERA mode only)

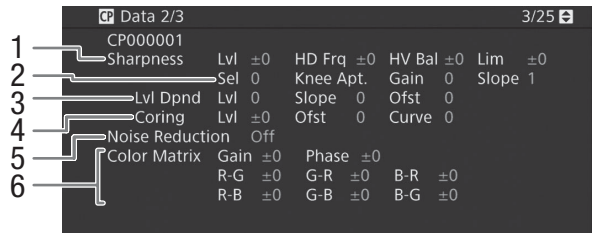

- | | |
|---|--|
| <ul style="list-style-type: none"> 1 Sharpness settings (level, horizontal detail frequency, horizontal/vertical detail balance, and limit) (📖 140) 2 Sharpness settings (select, knee aperture gain and slope) (📖 140) | <ul style="list-style-type: none"> 3 Level depend settings (level, slope and offset) (📖 140) 4 Coring settings (level, offset and curve) (📖 140) 5 Noise reduction (📖 141) 6 Color matrix fine-tuning settings (📖 142) |
|---|--|

[CP Data 3/3] Status Screens (CAMERA mode only)

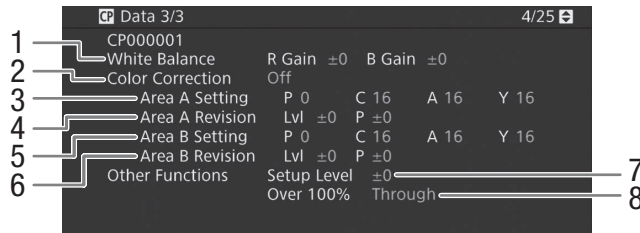

- | | |
|---|---|
| 1 White balance R/B gain (📖 142) | 5 Area B settings (phase, chroma, area and Y level) (📖 142) |
| 2 Color correction (📖 142) | 6 Area B revision settings (level and phase) (📖 142) |
| 3 Area A settings (phase, chroma, area and Y level) (📖 142) | 7 Setup level (📖 143) |
| 4 Area A revision settings (level and phase) (📖 142) | 8 Handling of clips exceeding 100% (📖 143) |

[Camera 1/4] to [Camera 4/4] Status Screens (CAMERA mode only)

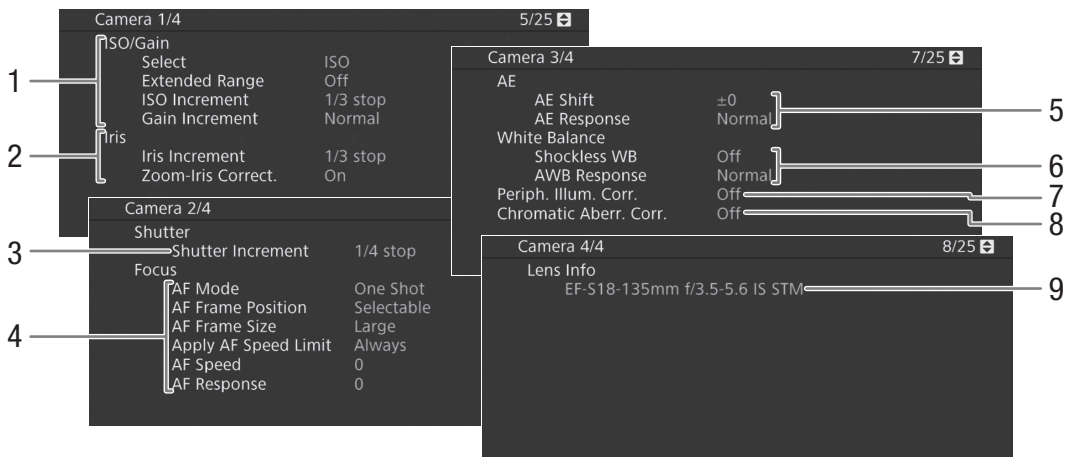

- | | |
|--|--|
| 1 ISO speed/Gain (📖 67)
Selected mode, extended range, ISO increment and gain increment | 5 Automatic exposure (AE)
AE shift (📖 72), AE response (📖 71, 72) |
| 2 Aperture (📖 70)
Iris increment, aperture correction while zooming | 6 White balance (📖 74)
Shockless white balance, auto white balance (AWB) response |
| 3 Shutter speed increment (📖 66) | 7 Correction for peripheral illumination (📖 37) |
| 4 Focus (📖 77)
AF mode, AF frame settings, AF speed and AF response settings | 8 Correction for chromatic aberration (📖 37) |
| | 9 Lens model name info (📖 36) |

[Assignable Buttons 1/4] to [Assignable Buttons 4/4] Status Screens*

* In **MEDIA** mode, [Assignable Buttons 1/3] to [Assignable Buttons 3/3].

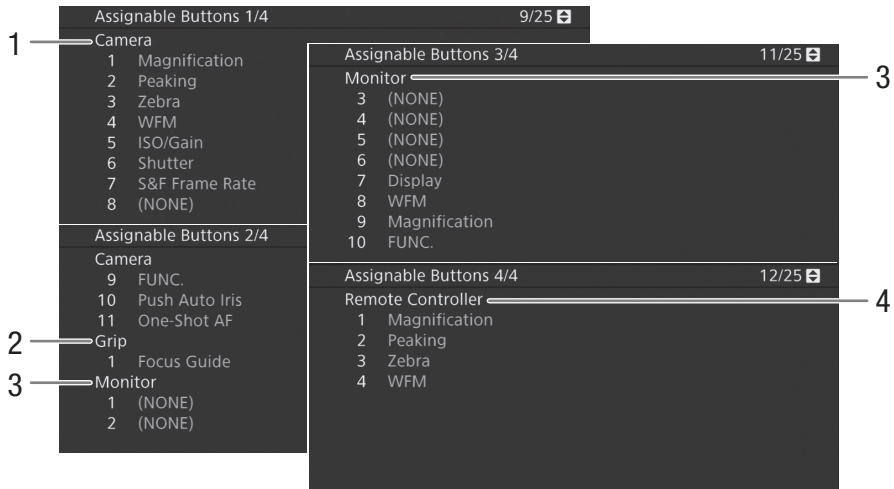

Current functions of the assignable buttons (📖 131)

- 1 On the camera's body
- 2 On the grip unit
- 3 On the monitor unit
(In **MEDIA** mode only buttons 7 to 10)
- 4 On the optional RC-V100 Remote Controller

[Audio] Status Screens

In **CAMERA** mode



In **MEDIA** mode

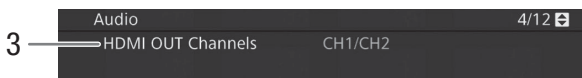

- 1 Audio source input and audio level adjustment mode for each audio channel (📖 96)
 - 2 Audio bit depth (📖 169) and audio channels (📖 169) used for recording or output.
[CFast]: Settings used for primary clips recorded on the CFast card.
[SD Card]: Settings used for proxy clips recorded on the SD card.
 - 3 Audio channels output from the HDMI OUT terminal (📖 169)
- [MON.], [REC OUT], [HDMI]: Settings used for audio output from the respective terminals.
[Headphone]: Settings used for audio output from the 🎧 (headphone) terminal.

[Media] Status Screen

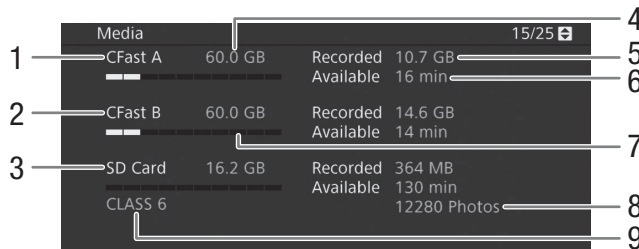

- 1 CFast card A
 - 2 CFast card B
 - 3 SD card
 - 4 Total space
 - 5 Used (recorded) space
 - 6 Available space
 - 7 Visual bar: Approximate used/available space
- Only for the SD card:**
- 8 Number of remaining photos
 - 9 SD speed class

NOTES

- Depending on the recording media, the total space displayed on the screen may differ from the nominal capacity listed on the CFast card or SD card.

[Video 1/3] to [Video 3/3] Status Screens*

* In **MEDIA** mode, [Video 1/2] to [Video 2/2].

196

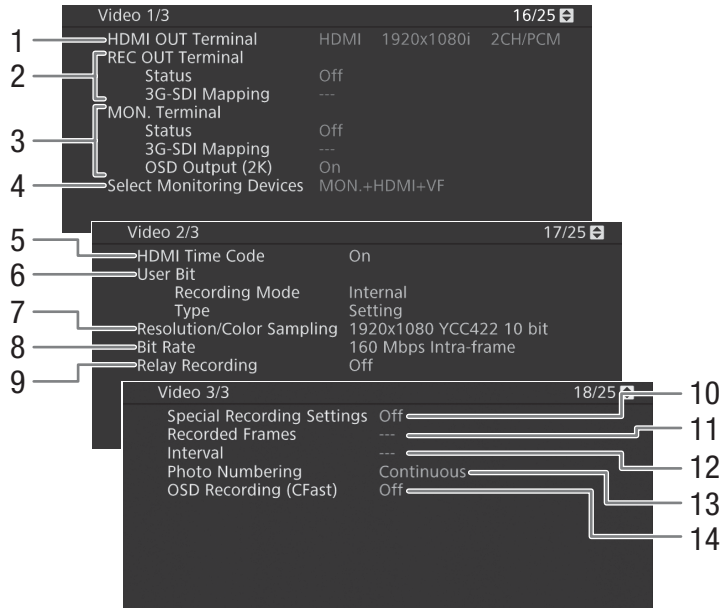

- | | |
|--|--|
| <ul style="list-style-type: none"> 1 HDMI OUT terminal status (📖 166): Signal type (HDMI/DVI), video output, audio output 2 REC OUT terminal status: Video output (📖 164), 3G-SDI output mapping (📖 165) 3 MON. terminal status: Video output (📖 164), 3G-SDI output mapping (📖 164), onscreen displays output (📖 168) 4 Monitoring devices (active screens and video outputs) (📖 186) 5 Time code output from the HDMI OUT terminal** (📖 166) 6 User bit** (📖 91) | <ul style="list-style-type: none"> 7 Resolution and color sampling** (📖 62) 8 Bit rate** (📖 63) 9 Relay recording** (📖 50) 10 Special recording mode** (📖 113) 11 Number of frames for interval recording mode (📖 117) or frame recording mode** (📖 116) 12 Interval length for interval recording mode** (📖 117) 13 Photo numbering (📖 176) 14 Recording of onscreen displays** (📖 144) |
|--|--|

** **CAMERA** mode only.

[Metadata 1/2], [Metadata 2/2] Status Screens (CAMERA mode only)

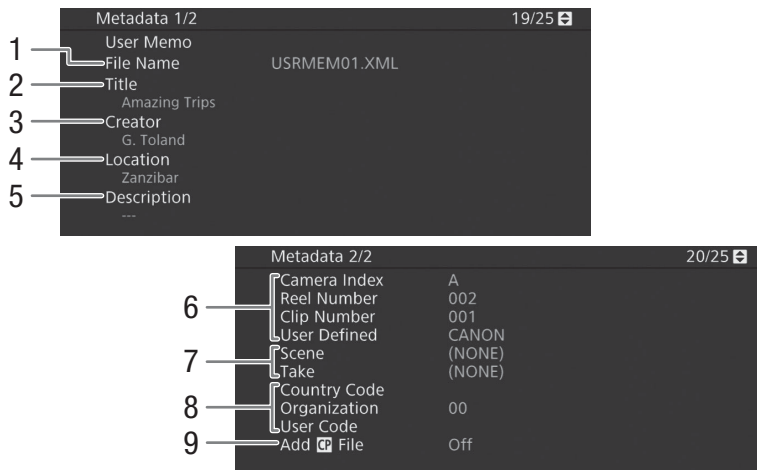

- | | |
|---|--|
| <ul style="list-style-type: none"> 1 User memo file name (📖 106) 2 Clip title 3 Camera operator 4 Filming location 5 Clip description 6 Clip name information (📖 60)
(camera index, reel number, clip number, user-defined field) | <ul style="list-style-type: none"> 7 Scene and take information (📖 107) 8 Unique material identifier (UMID) code (📖 184):
country, organization, user 9 Embed custom picture files with clips (📖 137) |
|---|--|

[Battery/Hour Meter] Status Screen

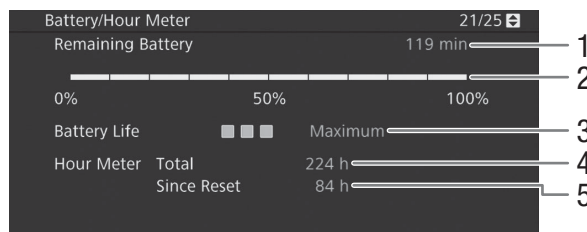

- | | |
|--|---|
| <ul style="list-style-type: none"> 1 Remaining recording time 2 Remaining recording time indicator 3 Battery life indicator | <ul style="list-style-type: none"> 4 Total operation time (📖 190) 5 Operation time since using [Reset Hour Meter] (📖 190) |
|--|---|

[GPS Information Display] Status Screen (CAMERA mode only)

198

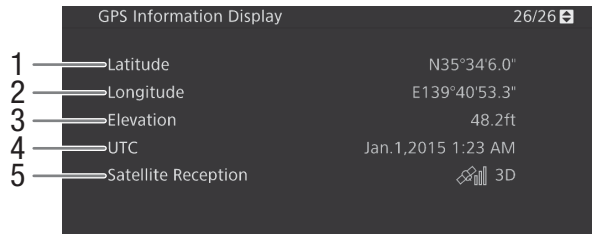

- 1 Latitude
- 2 Longitude
- 3 Elevation
- 4 UTC (coordinated universal time) date and time
- 5 Satellite signal strength

For details refer to *Recording GPS Information (Geotagging)* (📖 108).

Troubleshooting

If you have a problem with your camera, refer to this section. Consult your dealer or a Canon Service Center if the problem persists.

Power source

The camera will not turn on or it turns off by itself.

- The battery pack is exhausted. Replace or charge the battery pack.
- Remove the battery pack and reattach it correctly.

Shortly after turning it on, the camera turns off on its own.

- You are using a battery pack that is not compatible for use with this camera. Use a recommended battery pack (□ 211).

Cannot charge the battery pack.

- The temperature of the battery pack is outside the charging range. If the battery pack's temperature is below 0 °C (32 °F), warm it before charging it; if it is above 40 °C (104 °F), let the battery pack cool down before charging it.
- Charge the battery pack in temperatures between 0 °C and 40 °C (32 °F and 104 °F).
- The battery pack is faulty. Replace the battery pack.

The battery pack is exhausted extremely quickly even at normal temperatures.

- Check the [Battery/Hour Meter] status screen (□ 197) to check if the battery pack has reached the end of its battery life. If so, buy a new battery pack.

Recording

The camera's controls are not responsive/disabled.

- The grip unit's plug may not be correctly connected to the camera. When attaching the grip unit to the camera, make sure the grip unit's plug is firmly inserted all the way into the connection terminal on the camera (□ 43). If you changed the angle of the grip unit, make sure you did not partially disconnect the plug by mistake.
- When the **POWER** switch is set to **⏻**, all buttons (or all buttons with the exception of some START/STOP buttons) are locked and cannot be operated. Set the **POWER** switch to CAMERA. You can change which controls are locked with the [System Setup] ➤ [Custom Function] ➤ [Key Lock] setting (□ 144).

Pressing the START/STOP button will not start recording.

- The CFast card is full or it already contains the maximum number of clips (999 clips). Delete some clips (□ 156) or save your clips (□ 170) and initialize the CFast card (□ 49) to free some space. Alternatively, replace the CFast card.
- The START/STOP button that was used may be disabled. Change the current settings in the [System Setup] ➤ [Custom Function] ➤ [START/STOP Button] submenu (□ 144) to enable the use of the desired START/STOP buttons.
- The camera may be set to a special recording mode. If the special recording mode is no longer necessary, return [Recording/Media Setup] ➤ [Recording Mode] to [Normal Recording] to end the special recording mode.
- You may not be able to start or stop recording while controls on the optional RC-V100 Remote Controller are being operated. Stop using the remote controller and then press the START/STOP button.

The point where the START/STOP button was pressed does not match the beginning/end of the recording.

- There is a slight interval between pressing the START/STOP button and the actual start/end of recording. This is not a malfunction.

The camera will not focus.

- The camera may not be able to focus on certain subjects using autofocus. Focus manually (□ 78).
- When the AF mode is set to AF-boosted MF, start focusing manually until the AF frame changes to white (automatic adjustment range).
- The viewfinder is not adjusted. Use the dioptic adjustment lever to make the proper adjustment (□ 40).
- The lens is dirty. Clean the lens with a soft lens-cleaning cloth.

When a subject flits across in front of the lens, the image appears slightly bent.

- This is a phenomenon typical of CMOS image sensors. When a subject crosses very quickly in front of the camera, the image may seem slightly warped. This is not a malfunction.

Bright red, green or blue dots appear on the screen.

- Try adjusting the black balance (☐ 52). The camera's CMOS sensor is a delicate piece of precision engineering. Direct exposure of the sensor to ion rays or other types of cosmic radiation may affect it and this may rarely appear as bright colored dots on the screen. This is the nature of CMOS image sensors and does not represent a malfunction.
- The effects of the damage may be more noticeable when the camera is used in places subject to high temperatures, when a high ISO speed or gain level is used and when slow shutter speeds are used.

Abnormal images appear on the screen and the camera cannot record properly.

- While recording using an almost empty battery pack together with the AC adapter, the AC adapter was inadvertently disconnected or the power supply was suddenly interrupted. Reconnect the AC adapter and turn the camera off and then on again or replace the battery pack with a fully charged one.

Changing between recording (●REC) and record standby (STBY) takes longer than usual.

- When the recording media contains a large number of clips, some operations may take longer than usual. Save your clips (☐ 170) and initialize the recording media (☐ 49). Alternatively, replace the recording media.

The camera cannot record to a CFast card properly.

- This may occur as recordings are made and deleted over time. Save your clips (☐ 170) and initialize the recording media (☐ 49).

After using the camera for a long time, it becomes hot.

- The camera may become hot after using it continuously for long periods of time; this is not a malfunction. If the camera becomes unusually hot or it becomes hot after using it only for a short while, it may indicate a problem with the camera. Consult a Canon Service Center.

Playback

Cannot delete a clip.

- You cannot delete clips with an  mark. Remove the  mark (☐ 155) to delete the clip.
- The LOCK switch on the SD card is set to prevent accidental erasure. Change the position of the LOCK switch.

Deleting clips takes longer than usual.

- When the recording media contains a large number of clips, some operations may take longer than usual. Save your clips (☐ 170) and initialize the recording media (☐ 49).

Cannot delete a photo.

- The LOCK switch on the SD card is set to prevent accidental erasure. Change the position of the LOCK switch.
- Photos that were protected using other devices cannot be deleted with the camera.

Cannot copy clips.

- There is not enough available space on the CFast card being copied to or the CFast card already contains the maximum number of clips (999 clips). Delete some clips (☐ 156) to free some space or replace the CFast card.

Indicators and Onscreen Displays

 appears in red on the screen.

- Battery pack is exhausted. Replace or charge the battery pack.

 appears on the screen.

- The camera cannot communicate with the battery pack attached so the remaining battery time cannot be displayed.

The tally lamp does not illuminate.

- Set [System Setup]  [Tally Lamp] to [On].

The tally lamp flashes quickly.  (4 flashes per second)

- The battery pack is exhausted. Replace or charge the battery pack.
- There is not enough available space on the CFast card. Delete some clips (☐ 156) to free some space or replace the CFast card.
- A system error has occurred. Turn the camera off and then on again. If this does not solve the problem, consult a Canon Service Center.

The tally lamp flashes slowly.  (1 flash per second)

- The combined available space on both CFast cards is low. Replace the CFast card that is not being recorded onto.

 appears in red on the screen.

- An SD card error occurred. Remove and reinsert the SD card. If the display does not change back to normal, save your recordings (☐ 170) and initialize the SD card (☐ 49).
- The SD card is full. Replace the SD card or delete some recordings (☐ 156, 179) to free some space on the SD card.

Even after stopping recording, the access indicator stays illuminated in red.

- The clip is being recorded on the card. This is not a malfunction.

 appears in yellow on the screen.

- The camera's internal temperature has reached a predetermined level. You can continue using the camera.

 appears in red on the screen.

- The camera's internal temperature has risen further while  appeared in yellow on the screen.
- In **MEDIA** mode, or in **CAMERA** mode when [System Setup] ➤ [Fan] ➤ [Mode] is set to [Always On], turn off the camera and wait until the temperature has decreased.
- In **CAMERA** mode, if the fan mode is set to [Automatic] and the fan was turned off while recording, the fan will turn on automatically (in that case, **FAN** will appear on the screen).

 appears on the screen.

- The camera and lens cannot communicate normally. Clean the lens's contacts and reattach the lens.

 appears in red on the screen

- The lithium button battery's charge is low. Save the camera's settings on an SD card (□ 146) and replace the lithium button battery (□ 28). Then, restore the camera's settings from the file saved on the SD card.

Picture and Sound

The LCD screen or viewfinder does not turn on.

- LCD screen: Make sure the unit cable connecting the camera's VIDEO terminal and the monitor unit's VIDEO terminal is correctly connected on both sides.
- LCD screen: In **CAMERA** mode, check that [Picture/Terminals Setup] ➤ [Select Monitoring Devices] is set to an option that includes [LCD]. When it is set to [MON.+HDMI+VF], the LCD screen will not turn on.
- In **CAMERA** mode, when [Picture/Terminals Setup] ➤ [Select Monitoring Devices] is set to [MON.+HDMI+LCD(VF)], the LCD screen and viewfinder cannot be used simultaneously.

The peaking/magnification/zebra pattern/waveform monitor/B&W image does not appear on the screen.

- Check that display of the desired assistance function is enabled on the screen used with the corresponding output settings.

Screen displays turn on and off repeatedly.

- The battery pack is exhausted. Replace or charge the battery pack.
- Remove the battery pack and reattach it correctly.

Abnormal characters appear on the screen and the camera does not operate properly.

- Disconnect the power source and reconnect it after a short time. If the problem still persists, use the [System Setup] ➤ [Reset] ➤ [All Settings] function. This resets all the camera's settings to default values, except for the hour meter.

Video noise appears on screen.

- Keep a distance between the camera and devices that emit strong electromagnetic fields such as near powerful magnets and motors, MRI machines or high-voltage power lines.

Horizontal bands appear on the screen.

- This is a phenomenon typical of CMOS image sensors when recording under some types of fluorescent, mercury or sodium lamps. This is not a malfunction. You may be able to reduce the symptoms by setting the shutter speed mode to [Speed] and the shutter speed to a value matching the frequency of the local electrical system: 1/50* or 1/100 for 50 Hz systems, 1/60 or 1/120 for 60 Hz systems.

* May not be available depending on the frame rate.

Audio cannot be recorded.

- When using the INPUT 1/INPUT 2 terminals: Make sure the unit cable connecting the camera's AUDIO terminal and the AUDIO terminal on the supplied monitor unit or optional MA-400 Microphone Adapter is correctly connected on both sides.
- The external microphone connected to the INPUT 1/INPUT 2 terminal requires phantom power. Set the corresponding INPUT 1/INPUT 2 audio input selection switch to MIC+48V (□ 98).

Audio is recorded at an extremely low level.

- When using the INPUT 1/INPUT 2 terminals: The audio level switch for CH1 or CH2 is set to M, and the recording level is set too low. When using the MIC terminal: [Audio Setup] ➤ [Audio Input] ➤ [MIC Mode] is set to [Manual] and [MIC Level] is set to a level too low. Check the audio level meter on the screen or rear panel and adjust the audio level correctly (□ 99, 100).
- The microphone attenuator is on. Turn off the microphone attenuator (□ 100, 101).

Sound is distorted or is recorded at lower levels.

- When recording near loud sounds (such as fireworks, shows or concerts), sound may become distorted or it may not be recorded at the actual levels. Activate the microphone attenuator (📖 100, 101), or adjust the audio recording level manually.

Recording Media and Accessories

Cannot insert the recording media.

- The CFast card or SD card you are trying to insert is not facing the correct direction. Turn it over and insert it.

Cannot record on the CFast card.

- A compatible CFast card must be used (📖 46).
- Initialize the CFast card (📖 49) when you use it with the camera for the first time.
- The CFast card is full or it already contains the maximum number of clips (999 clips). Delete some clips (📖 156) to free some space or replace the CFast card.

Cannot record on the SD card.

- A compatible SD card must be used (📖 46).
- Initialize the SD card (📖 49) when you use it with the camera for the first time.
- The LOCK switch on the SD card is set to prevent accidental erasure. Change the position of the LOCK switch.
- The SD card is full or it already contains the maximum number of clips (999 clips). Delete some recordings (📖 156, 179) to free some space or replace the SD card.
- The folder and file numbers have reached their maximum value. Set the [Recording/Media Setup] ➤ [Photo Numbering] setting to [Reset] and insert a new SD card.

Recording to and playing back from a CFast card is slow.

- This may occur as video is recorded/deleted over time. Save your clips (📖 170) and initialize the CFast card (📖 49).

Recording to and playing back from an SD card is slow.

- This may occur as clips and photos are recorded/deleted over time. Save your recordings (📖 170) and initialize the SD card using the [Complete] option (📖 49).

The optional RC-V100 Remote Controller or commercially available remote control does not work.

- Make sure that [System Setup] ➤ [REMOTE Term.] is set to [RC-V100] when using the optional RC-V100 Remote Controller or [Standard] when using a commercially available remote control.
- Turn off the camera, reconnect the remote controller and then turn the camera back on again.
- When [Custom Picture] ➤ [Other Settings] ➤ [Activate] is set to [Off] or the currently selected custom picture file is protected, detailed custom picture settings cannot be adjusted using the RC-V100. Set [Activate] to [On] after selecting a custom picture file that is not protected (📖 134).

Connections with External Devices

Video noise appears on a nearby TV screen.

- When using the camera in a room where a TV is located, keep a distance between the AC adapter and the power or antenna cables of the TV.

Playback looks fine on the camera but there is no image on the external monitor.

- The camera is not connected correctly to the external monitor. Make sure you are using the correct connection (📖 163).
- The video input on the external monitor is not set to the video terminal to which you connected the camera. Select the correct video input.

There is no picture or sound from an external monitor connected to the REC OUT terminal

- In **CAMERA** mode, check that [Recording/Media Setup] ➤ [REC OUT 4K RAW Mode] is set to an option other than [Off].
- In **MEDIA** mode, check that [Picture/Terminals Setup] ➤ [REC OUT/MON. Terminal] ➤ [Output] is set to an option other than [Off].
- Check that the external monitor's settings match the configuration of the output signal selected on the camera (📖 161).

There is no picture or sound from an external monitor connected to the MON. terminal

- In **CAMERA** mode, check that [Picture/Terminals Setup] ➤ [Select Monitoring Devices] is set to an option that includes [MON.].
- Check that [Picture/Terminals Setup] ➤ [MON. Terminal] (**CAMERA** mode) or [REC OUT/MON. Terminal] (**MEDIA** mode) ➤ [Output] is set to an option other than [Off].
- Check that the external monitor's settings match the configuration of the output signal selected on the camera (📖 161).

There is no picture or sound from an external monitor connected to the HDMI OUT terminal

- Disconnect the HDMI cable and then restore the connection or turn the camera off and then on again.
- In [CAMERA] mode, check that [Picture/Terminals Setup] ► [Select Monitoring Devices] is set to an option that includes [HDMI].

The peaking/magnification/zebra pattern/waveform monitor/B&W image does not appear on an external monitor connected to the MON. terminal or HDMI OUT terminal.

- Check that display of the desired assistance function is enabled for the video output used with the corresponding [Output to MON. & HDMI] setting ([Output] setting in the case of the waveform monitor).

List of Messages

Refer to this section if a message appears on the screen. The messages in this section appear in alphabetical order. Note that for some messages, an indication of the recording media involved (CFast A, CFast B, [SD], or a combination thereof) may appear above the message itself.

For error messages related to network connections, refer to the *Troubleshooting* section of the 'WFT-E6: Guide for EOS C300 Mark II Users' (PDF file).

Accessing CFast A/CFast B/[SD] Do not remove

- You opened the CFast card slot cover or SD card slot cover while the camera was accessing the recording media. Close the card slot cover.

Battery communication error. Does this battery display the Canon logo?

- This may be due to using a battery pack not recommended by Canon for use with this camera.
- If you are using a battery pack recommended by Canon for use with this camera, there may be a problem with the battery pack or camera. Consult a Canon Service Center.

Buffer overflow. Recording was stopped.

- The data transfer rate was too high for the recording media in use and the recording was stopped. Use a recommended recording media ([46]).

Camera ↔ Lens communication error. Clean the lens's contacts and reattach the lens.

- The camera cannot correctly communicate with the lens due to dirty lens contacts. After the message disappears, the [LENS] icon appears on the screen. Clean the lens's contacts and reattach the lens.

Cannot play back

- The file control information is corrupted or there was a decoder error. Turn the camera off and then on again. If this does not solve the problem, consult a Canon Service Center.
 - Corrupted file control information cannot be recovered. Recording media or clips with corrupt file control information cannot be read by Canon XF Utility for XF-AVC.

Cannot switch CFast card slots

- The SLOT SELECT button was pressed while the camera is recording. Wait until recording is finished to change the selected CFast card slot.

CFast A→CFast B / CFast B→CFast A Switched

- This message appears when you use the SLOT SELECT button to switch the CFast card slot in use or recording continued from one CFast card to the other.

CFast A→CFast B / CFast B→CFast A Will switch in a moment

- The CFast card is almost full so recording will continue on the other CFast card in approximately 1 minute.

Change the battery pack

- The battery pack is exhausted. Replace or charge the battery pack.

Check the CFast A/CFast B/[SD]

- Cannot access the recording media. Check the recording media and make sure it is inserted correctly.
- A recording media error occurred. The camera cannot record or display the image. Try removing and reinserting the recording media, or use a different recording media.
- You inserted a MultiMedia Card (MMC) into the camera. Use a recommended SD card ([46]).
- If after the message disappears, [A], [B] or [SD] appears in red, perform the following: Turn off the camera and remove and reinsert the recording media. If [A], [B] or [SD] turns back to green you can resume recording/playback. If the problem persists, save your recordings ([170]) and initialize the recording media ([49]).

Check the connection of the grip unit

- The grip unit may not be attached correctly. Check the connection.

Check the data on CFast A/CFast B/[SD] Initializing the card is also recommended

- The recording media cannot be used for any of the following reasons.
 - A problem has occurred with the recording media.
 - The camera cannot read the data on the recording media.
 - The recording media was initialized using a computer.
 - The recording media is partitioned.
- Save your clips (☐ 170) and initialize the recording media (☐ 49).

Check the device connected to the camera's system extension terminal

- There is a problem with the optional accessory connected to the camera's system extension terminal. Try removing the accessory and attaching it again. If this does not solve the problem, consult a Canon Service Center.

Cover is open

- The CFast card slot cover or SD card slot cover was open when the camera was switched to or turned on in CAMERA mode. Insert a card and close the card slot the cover.

Currently, this screen cannot be used together with the LCD screen.

- [Picture/Terminals Setup] ➤ [Select Monitoring Devices] is set to [MON.+HDMI+LCD(VF)] so the viewfinder cannot be used simultaneously with the LCD screen. To use both the LCD screen and the viewfinder in CAMERA mode, set [Select Monitoring Devices] to [LCD+VF] (☐ 186).

Fan error

- The cooling fan may not be working properly. Consult a Canon Service Center.

File name error

- The clip number has reached its maximum value. Save your clips (☐ 170) and initialize the recording media (☐ 49) or delete all the clips (☐ 156).
- Photo numbers have reached their maximum value. Set [Recording/Media Setup] ➤ [Photo Numbering] to [Reset] and delete all the photos on the SD card (☐ 179) or initialize it (☐ 49).

Invalid operation

- The following operations cannot be performed.
 - Adding a shot mark to a clip that already has a shot mark or to a clip in frame recording mode or interval recording mode.
 - Adding an mark to a clip that already has an mark or adding a mark to a clip that already has a mark.
 - In CAMERA mode, immediately reviewing a recording made in a special recording mode.
 - Pressing the START/STOP button when there are no recording media in the camera.

Lens error Change the frame rate

- The lens attached to the camera is not compatible for shooting at the frame rate selected on the camera. Select a different the frame rate (☐ 62).

Lens error Turn the camcorder off, then on again.

- There was a communication error between the camera and the lens. Turn the camera off and then on again.

Lens firmware update Firmware update failed. Try updating again.

- The lens's firmware could not be correctly updated. Try updating the lens's firmware again.

Management file error

- Cannot record because the camera cannot write to the file control information. This may occur if the files on the recording media were accessed using another device. Save your clips (☐ 170) and initialize the recording media (☐ 49).

May not be possible to record movies on this memory card

- You may not be able to record clips on an SD card without a Speed Class rating or rated CLASS 2 or 4. Replace the SD card with one rated CLASS 6 or 10.

Media full

- The recording media is full. Delete some clips (☐ 156) to free some space or replace the recording media.
- CFast card A or CFast card B is full so recording will not start. Switch to the CFast card in the other CFast card slot to record.

Media is almost full

- The amount of available space on CFast card A and CFast card B combined is low. Replace the CFast card that is not selected.
- The amount of available space on the SD card is low. Replace the SD card or delete some recordings (☐ 156, 179) to free some space on the SD card.

Media is not supported

- 512 MB or smaller CFast cards and 128 MB or smaller SD cards cannot be used with the camera. Use a recommended recording media (☐ 46).

Memory card is write-protected

- The LOCK switch on the SD card is set to prevent accidental erasure. Change the position of the LOCK switch.

No clips

- There are no clips on the recording media to play back. Clips must be recorded (☐ 53) in order to play them back.

No photos

- There are no photos on the SD card to play back. Photos must be taken (☐ 175) in order to view them.

No Shot Marks

- This message appears if shot marks in a clip were deleted from the [Shot Mark] index screen. Press the INDEX button to return to the clip index screen.

Number of clips already at maximum

- The recording media selected for recording already contains the maximum number of clips (999 clips). Replace the recording media or use the CFast card in the other CFast card slot.
- Because both CFast cards reached the maximum number of clips, double slot recording is not available.

Number of Shot Marks at maximum

- The shot mark could not be added because the clip already contains 100 shot marks (☐ and ☐ marks combined). You must delete shot marks (☐ 159) before adding any more.

Recorded at 24.00 Hz/50.00 Hz/59.94 Hz Check the data on CFast A/CFast B/☐ Initializing the card is also recommended.

- The recording media contains clips that were recorded using a system frequency different from the one currently used by the camera. To record on this card, save your clips (☐ 170) and initialize the recording media with the camera (☐ 49). To play back the recordings on the card, change the [Recording/Media Setup] ➤ [System Frequency] setting to match the recordings on the recording media.

Recording was stopped.

- The file control information is corrupted or there was an encoder error. Turn the camera off and then on again. Then, remove the CFast card being used and reinsert it. Alternatively, replace the CFast card. If this does not solve the problem, consult a Canon Service Center.
 - Corrupted file control information cannot be recovered. Recording media or clips with corrupt file control information cannot be read by Canon XF Utility for XF-AVC.

Some clips require data recovery

- The power may have been suddenly turned off or the recording media may have been removed while the camera was recording. As a result, one or more clips contain corrupted data. You can try to recover the clips (☐ 51).

The number of ND filters used has changed. Check the focus.

- When using ND filter settings in the extended range (8 stops or 10 stops), the number of ND filters used changes and this may result in a shift in focus. Check the focus before resuming shooting.

This function is not compatible with the current lens.

- The selected setting is not compatible with the lens currently attached to the camera and cannot be used.

This photo cannot be displayed

- You may not be able to display photos taken with other devices or image files created or edited on a computer.

This screen is currently not active.

- To use the LCD screen in ☐ CAMERA mode, make sure that [Picture/Terminals Setup] ➤ [Select Monitoring Devices] is set to an option that includes [LCD] (☐ 186).

Unable to recover data

- Could not recover the selected clip. Save your clips (☐ 170) and delete the clips that could not be recovered (☐ 156).
- The camera may not be able to recover clips when there is not enough space on the recording media. Delete some clips (☐ 156) to free some space.

Wireless communication cannot be used while the wireless microphone is attached

- Wi-Fi connections cannot be used while an optional WM-V1 Wireless Microphone is attached to the camera. Disconnect the WM-V1 from the camera and turn it off.

Handling Precautions

Camera

Be sure to observe the following precautions to ensure maximum performance.

- Do not carry the camera by the LCD panel or monitor unit. Be careful when closing the LCD panel.
- Do not leave the camera in places subject to high temperatures (like the inside of a car parked under direct sunlight), or high humidity.
- Do not use the camera near strong electromagnetic fields such as near powerful magnets and motors, MRI machines or high-voltage power lines. Using the camera in such places may cause anomalies in the video, or audio or video noise to appear.
- Do not use or store the camera in dusty or sandy places. The camera is not waterproof – avoid also water, mud or salt. If any of the above should get into the camera it may damage the camera and/or the lens. Consult a Canon Service Center as soon as possible.
- Be careful to avoid dust and dirt particles accumulating on the lens or entering the camera. When you finish using the camera, make sure to attach the body cap to the lens mount and the lens cap and dust cap to the lens.
- Do not point the camera or viewfinder toward an intense light source, such as the sun on a sunny day or an intense artificial light source. Doing so may damage the image sensor or the camera's internal components. Be careful especially when using a tripod or shoulder strap. When you are not using the camera or viewfinder, make sure to attach the lens cap to the lens and the viewfinder cap to the viewfinder.
- Be careful of heat generated by lighting equipment.
- Do not disassemble the camera. If the camera does not function properly, consult qualified service personnel.
- Do not touch the lens contacts on the lens mount. Dirty contacts may cause a poor contact between the camera and the lens resulting in incorrect operation of the camera. After removing the lens, make sure to attach the body cap to the lens mount and the lens cap and dust cap to the lens.
- Handle the camera with care. Do not subject the camera to shocks or vibration as this may cause damage. When using the shoulder strap, do not allow the camera to swing and hit an object.



Long-term storage

If you do not intend to use the camera for a long time, store it in a place free of dust, in low humidity, and at temperatures not higher than 30 °C (86 °F).

Battery Pack

DANGER!

Treat the battery pack with care.

- Keep it away from fire (or it might explode).
- Do not expose the battery pack to temperature higher than 60 °C (140 °F). Do not leave it near a heater or inside a car in hot weather.
- Do not try to disassemble or modify it.
- Do not drop it or subject it to shocks.
- Do not get it wet.

- Dirty terminals may cause a poor contact between the battery pack and the camera. Wipe the terminals with a soft cloth.

Long-term storage

- Store battery packs in a dry place at temperatures no higher than 30 °C (86 °F).
- To extend the battery life of the battery pack, discharge it completely before storing it.
- Charge and discharge all your battery packs fully at least once a year.

Always attach the battery terminal cover.

Do not allow any metal objects to touch the terminals (Figure 1), as this can cause a short circuit and damage the battery pack. Attach the terminal cover whenever the battery pack is not being used (Figure 2).

The battery terminal cover has a [□]-shaped hole. This is useful when you wish to differentiate between charged and uncharged battery packs. For example, with charged battery packs, attach the terminal cover so that the [□]-shaped hole shows the colored label.

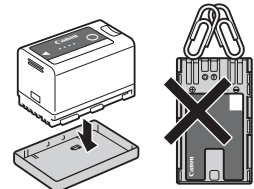
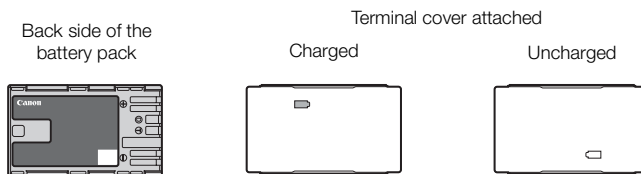

Figure 1

Figure 2



Remaining battery time

If the remaining battery time displayed is not correct, charge the battery pack fully. Still, the correct time may not be displayed if a fully charged battery pack is used continuously in high temperatures or it is left unused for long periods of time. Also, the correct remaining time may not be displayed, depending on the battery life. Use the time shown on the screen as an approximation.

Using higher capacity batteries

You can use the optional BP-A60 Battery Pack with this camera. However, as the battery compartment cover cannot be closed when using this higher capacity battery pack, you will need to remove it beforehand. Note that removing the battery compartment cover will render the camera more exposed to moisture, dust and foreign objects.

- 1 Slide down the BATT. OPEN switch and open the battery compartment cover.
- 2 Push the latch at the bottom of battery compartment.
- 3 Gently pull out the battery compartment cover.

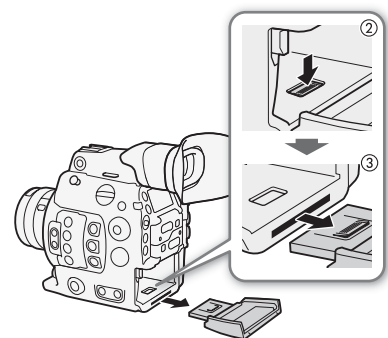

Lithium Button Battery

WARNING!

- The battery used in this device may present a fire or chemical burn hazard if mishandled.
- Do not disassemble, modify, immerse in water, heat above 100 °C (212 °F) or incinerate the battery.
- Do not insert the battery into the mouth. If swallowed, seek medical assistance immediately. The battery case may break and the battery fluids may cause internal injuries.
- Keep the battery out of the reach of children.
- Do not recharge, short-circuit or insert the battery in the wrong direction.
- Dispose of the used battery according to applicable recycling regulations. In Europe, the used battery should be returned to the supplier for safe disposal.

- Do not pick up the battery using tweezers or other metal tools, as this will cause a short circuit.
- Wipe the battery with a clean dry cloth to ensure proper contact.
- For CA, USA only
Included lithium battery contains Perchlorate Material - special handling may apply.
See www.dtsc.ca.gov/hazardouswaste/perchlorate/ for details.

Recording Media

- We recommend backing up the recordings on the recording media onto your computer. Data may be corrupted or lost due to defects or exposure to static electricity. Canon shall not be liable for lost or corrupted data.
- Do not touch or expose the terminals to dust or dirt.
- Do not use recording media in places subject to strong magnetic fields.
- Do not leave recording media in places subject to high humidity and high temperature.
- Do not disassemble, bend, drop, or subject recording media to shocks and do not expose them to water.
- Check the direction before inserting the recording media. Forcing recording media into the slot if it is not correctly oriented may damage the recording media or the camera.
- Do not attach any labels or stickers on the recording media.

Disposal

When you delete data on the recording media, only the file allocation table is altered and stored data is not physically erased. Take the necessary precautions when you dispose of the recording media, for example by physically damaging it to prevent the leakage of private data.

If giving the recording media to another person, initialize it (using the [Complete] initialization option for SD cards,  49). Fill it up with unimportant recordings, and then initialize it again. This makes recovering the original recordings very difficult.

Maintenance/Others

Cleaning

Camera Body

- Use a soft, dry cloth to clean the camera's body. Never use chemically treated cloths or volatile solvents such as paint thinner.

Lens

- Remove any dust or dirt particles using a non-aerosol type blower brush.
- Use a clean, soft lens-cleaning cloth to gently wipe the lens. Never use tissue paper.

LCD Screen

- Clean the LCD screen using a clean, soft lens-cleaning cloth and commercially available cleaning fluid for eyeglasses.
- Condensation may form on the surface of the screen when the temperature changes suddenly. Wipe it with a soft dry cloth.

Condensation

Moving the camera rapidly between hot and cold temperatures may cause condensation (water droplets) to form on its internal surfaces. Stop using the camera if condensation is detected. Continued use may damage the camera.

Condensation may form in the following cases:

- When the camera is moved quickly from cold to warm places
- When the camera is left in a humid room
- When a cold room is heated rapidly

To avoid condensation

- Do not expose the camera to sudden or extreme changes in temperature.
- Remove the recording media and battery pack. Then, place the camera in an airtight plastic bag and let it adjust gradually to temperature changes before removing it from the bag.

When condensation is detected

The precise time required for water droplets to evaporate will vary depending on the location and weather conditions. As a general rule, wait for 2 hours before resuming use of the camera.

Using the Camera Abroad

Power Sources

You can use the AC adapter to operate the camera and the battery charger to charge battery packs in any country/region with power supply between 100 and 240 V AC, 50/60 Hz. Consult a Canon Service Center for information on plug adapters for overseas use.

Optional Accessories

The following optional accessories are compatible with this camera. The availability differs from area to area.

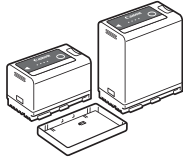

BP-A30, BP-A60
Battery Pack

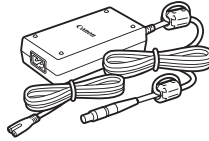

CA-A10 AC Adapter

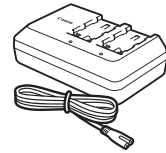

CG-A10 Battery Charger



RD-1 Rod Clamp
(coming soon)



UN-5 Unit Cable (50 cm, 1.6 ft.)/
UN-10 Unit Cable (1 m, 3.3 ft.)



TB-1 Tripod Adapter Base

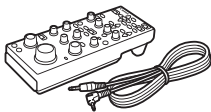

RC-V100
Remote Controller



WFT-E6
Wireless File Transmitter

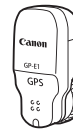

GP-E1 GPS Receiver



MA-400
Microphone Adapter
(coming soon)

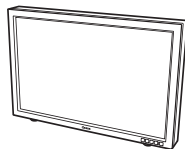

DP-V3010 Video Display/
DP-V2410 Video Display
(4K reference displays)

For our customers in the USA: Call or visit your local retailer/dealer for genuine Canon video accessories. You can also obtain genuine accessories for your Canon camera by calling: 1-800-828-4040, Canon U.S.A. Information Center.

Use of genuine Canon accessories is recommended.

The message [Battery communication error] is displayed if you use a non-genuine Canon battery pack, and user response is required. Note that Canon shall not be liable for any damages resulting from accidents, such as malfunction or fire, that occur due to use of non-genuine Canon battery packs.

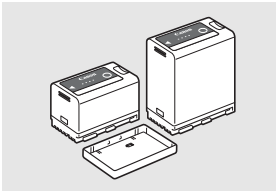
**Battery Packs**

When you need extra battery packs, select only the BP-A30 or BP-A60 Battery Pack.



This mark identifies genuine Canon video accessories. When you use Canon video equipment, we recommend Canon-brand accessories or products bearing the same mark.

i NOTES

- You can have the camera's EF lens mount replaced by an EF lens mount with Cinema Lock or by a PL lens mount. For details, consult the retail dealer from whom you purchased the camera or contact a Canon Service Center.

Specifications

C300 Mark II

System

- **Recording System**

Movies: Video compression: MPEG-4 AVC/H.264, Intra-frame or Long GOP
 Audio compression: Linear PCM, 16 bit or 24 bit, 48 kHz, 4 channels
 File format: MXF

Photos: DCF (Design rule for Camera File system), compatible with Exif Ver. 2.3, JPEG compression

- **Video Configuration¹ (recording/playback)**

Primary clips:

Resolution: 4096x2160, 3840x2160, 2048x1080, 1920x1080
 Bit rate: 410 Mbps, 310 Mbps, 225 Mbps, 210 Mbps, 160 Mbps (Intra-frame);
 50 Mbps (Long GOP)
 Color sampling: YCbCr 4:2:2, 10 bit; RGB 4:4:4, 12 bit; RGB 4:4:4, 10 bit
 Frame rate: 59.94P, 59.94i, 50.00P, 50.00i, 29.97P, 23.98P, 25.00P, 24.00P

Proxy clips:

Resolution: 2048x1080, 1920x1080
 Bit rate: 35 Mbps, 24 Mbps (Long GOP)
 Color sampling: YCbCr 4:2:0, 8 bit
 Frame rate: 59.94P, 59.94i, 50.00P, 50.00i, 29.97P, 23.98P, 25.00P, 24.00P

¹ Available options may differ depending on the system frequency currently in use.

- **Recording Media (not included)**

For approximate recording times, refer to the *Reference Tables* (□ 217)

Primary clips: CFast 2.0 card (2 slots)

Proxy clips and photos²: SD, SDHC (SD High Capacity) or SDXC (SD eXtended Capacity) memory card

² Custom picture files, camera settings and user memo files can be saved on and read from the SD card as well.

- **Image Sensor** Super-35mm-equivalent CMOS sensor

Effective pixels (approximate):

When the resolution is 4096x2160, 2048x1080: 8,850,000 pixels (4096x2160)

When the resolution is 3840x2160, 1920x1080: 8,290,000 pixels (3840x2160)

- **Viewfinder:** 1.2 cm (0.46 in.) organic LED display, approx. 1,770,000 dots, 100% coverage

- **Lens Mount**

Canon EF mount compatible with Canon EF lenses (including EF-S lenses)

Lens multiplication factor for 35mm equivalent focal length (approximate):

When the resolution is 4096x2160, 2048x1080: 1.46

When the resolution is 3840x2160, 1920x1080: 1.53

- **Lens Correction**

Peripheral illumination/chromatic aberration correction is available for Canon EF lenses³

³ Some Canon EF lenses are not compatible with in-camera correction.

- **Shutter Speed**

Speed (1/3-stop increments, 1/4-stop increments), angle, clear scan, slow, off

- **Iris:** Manual (1/2-stop increments, 1/3-stop increments, fine-tuning), push auto iris, automatic aperture⁴

⁴ Only with compatible lenses (□ 213).

- **ISO Speed**

ISO 100⁵, ISO 125⁵, ISO 160 to ISO 25600, ISO 32000⁵ to ISO 102400⁵ (1-stop or 1/3-stop increments)

- **Gain**

-6 dB⁵, -3 dB⁵, -2 dB, 0 dB to 42 dB, 45 dB⁵ to 54 dB⁵ (3-dB increments),

-2 dB to 24 dB (fine-tuning in 0.5-dB increments)

⁵ With extended ISO/Gain range.

- **ND Filter:** Built-in (Off, 2, 4, 6, 8⁶ or 10⁶ stops), motor operated
⁶ With extended ND range.
- **Exposure:** AE shift, light metering modes (standard, spotlight, backlight)
- **White Balance**
 Custom white balance (two sets, A and B); color temperature setting (2,000 K to 15,000 K); two preset settings (daylight, 5,400 K⁷ and incandescent lamp, 3,200 K⁷) that can be further fine-tuned
⁷ Color temperatures are approximate and given for reference purposes only.
- **Focus**
 Manual focus, autofocus (one-shot AF, AF-boosted MF, continuous AF, Face AF); face detection and subject tracking available
 AF type: Dual Pixel CMOS AF, contrast-detection AF
- **Sensor Sensitivity (ISO 800, 2000 lux, 89.9% reflection)**
 59.94 Hz: F10 (2048x1080 at 59.94P); 50.00 Hz: F11 (2048x1080 at 50.00P)
- **S/N Ratio (ISO 800, using Canon Log 2 gamma)**
 67 dB (typical, 1920x1080, at 29.97P (59.94 Hz) or 25.00P (50.00 Hz))
- **Subject Illumination (ISO 25600, with a f/1.2 lens, 100% output)**
 59.94 Hz: 0.45 lux (shutter speed 1/30)
 50.00 Hz: 0.38 lux (shutter speed 1/25)
- **Built-in microphone:** Monaural electric condenser microphone
- **Size of Photos:** 2048x1080, 1920x1080

Compatible EF Lenses

The following lenses are compatible with push auto iris and automatic aperture:

EF-S 10-18mm f/4.5-5.6 IS STM	EF-S 18-135mm f/3.5-5.6 IS STM
EF-S 18-55mm f/3.5-5.6 IS STM	EF-S 55-250mm f/4-5.6 IS STM
EF 24-105mm f/3.5-5.6 IS STM	

Terminals

- **REC OUT Terminal / MON. Terminal**
 BNC jack, output only, 0.8 Vp-p / 75 Ω, unbalanced
 3G-SDI: SMPTE 424, SMPTE 425, SMPTE ST 299-2
 HD-SDI: SMPTE 292, SMPTE ST 299-1
 Embedded audio, time code (VITC/LTC)
 LUT (BT.709, BT.2020, DCI, ACESproxy10), color space for 4K RAW output (BT.2020, Cinema Gamut), and supplemental displays* (superimposed onscreen displays, peaking, zebra pattern, magnification, B&W image, waveform monitor) can also be output.
 * MON. terminal only.
- **HDMI OUT Terminal**
 HDMI connector, output only
 Time code, LUT (BT.709, BT.2020, DCI, ACESproxy10) and supplemental displays (superimposed onscreen displays, peaking, zebra pattern, magnification, B&W image, waveform monitor) can also be output.
- **MIC Terminal**
 Ø 3.5 mm stereo mini-jack, -72 dBV (manual volume center, full scale -18 dB) / 5.6 kΩ
 Microphone attenuator: 20 dB
- **🎧 (Headphone) Terminal**
 Ø 3.5 mm stereo mini-jack, -∞ to -8 dBV (16 Ω load, volume range Min to Max) / 50 Ω or less
- **GENLOCK/SYNC OUT Terminal**
 BNC jack, 1 Vp-p / 75 Ω
 GENLOCK setting: input only; SYNC OUT setting: output only, tri-level HD signal

- **TIME CODE Terminal**
BNC jack, input/output
Input setting: 0.5 Vp-p to 18 Vp-p / 100 k Ω ; Output setting: 1.3 Vp-p / 50 Ω or less
- **REMOTE Terminal**
Ø 2.5 mm stereo mini-jack
- **VIDEO Terminal**
Proprietary connector for the supplied monitor unit; output only
- **AUDIO Terminal**
Proprietary connector for the supplied monitor unit or the optional MA-400 Microphone Adapter; input only
- **Grip Unit Connection Terminal**
Proprietary connector for the supplied Grip Unit connection plug
- **System Extension Terminal**
Proprietary connector for optional accessories

Power/Others

- **Power Supply (rated)**
14.4 V DC (battery pack), 16.7 V DC (DC IN)
- **Power Consumption (with the REC OUT terminal, LCD screen and viewfinder active)**
19.6 W (4K recording at 29.97P), 21.2 W (2K recording at 59.94P)
19.2 W (4K recording at 25.00P), 20.5 W (2K recording at 50.00P)
- **Operating Temperature**
0 – 40 °C (32 – 104 °F)
- **Dimensions (W x H x D)***
Minimal configuration with thumb rest: 149 x 183 x 183 mm (5.9 x 7.2 x 7.2 in.)
Configuration with grip unit and grip belt: 190 x 183 x 187 mm (7.5 x 7.2 x 7.4 in.)
Configuration with grip unit and monitor unit: 190 x 253 x 206 mm (7.5 x 10.0 x 8.1 in.)
Configuration with grip unit, bracket, handle unit and monitor unit: 190 x 307 x 326 mm (7.5 x 12.1 x 12.8 in.)
* All dimensions are approximate.
- **Weight ****
Camera unit only: 1,770 g (3.9 lb.)
Camera with grip unit and monitor unit***: 3,085 g (6.8 lb.)
Camera with grip unit, bracket, handle unit and monitor unit***: 3,435 g (7.6 lb.)
**All weights are approximate.
***Working configuration includes also battery pack (BP-A30 x1), recording media (CFast card x2), and unit cables (x2).
- **Approximate continuous recording time with a fully charged battery pack):**
4K recording at 29.97P: 125 min. (supplied BP-A30 battery pack),
265 min. (optional BP-A60 battery pack)
4K recording at 25.00P: 130 min. (supplied BP-A30 battery pack),
270 min. (optional BP-A60 battery pack)
2K recording at 59.94P: 115 min. (supplied BP-A30 battery pack),
245 min. (optional BP-A60 battery pack)
2K recording at 50.00P: 120 min. (supplied BP-A30 battery pack),
250 min. (optional BP-A60 battery pack)

Modular Units

Monitor Unit

Modular unit can be rotated 270° on its axis; includes the LCD panel, recording and playback controls, two audio INPUT terminals and related audio controls.

- **LCD Panel:** Articulated panel, 270° vertical rotation, 180° lateral rotation
- **LCD Screen:** 10.1 cm (4.0 in.), approx. 1,230,000 dots, 100% coverage
- **INPUT 1/INPUT 2 Terminals**
XLR jack (pin1: shield, pin2: hot, pin3: cold), 2 sets
Sensitivity
MIC setting: -60 dBu (manual volume center, full scale -18 dB) / 600 Ω
LINE setting: 4 dBu (manual volume center, full scale -18 dB) / 10 kΩ
Microphone attenuator: 20 dB
- **VIDEO Terminal**
Proprietary connector for connection to the camera; input only
- **AUDIO Terminal**
Proprietary connector for connection to the camera; output only
- **Weight:** Approx. 680 g (1.5 lb.)

Grip Unit

Modular unit can be attached at any of 24 positions (15° intervals); includes limited recording controls.

- **Weight:** Approx. 230 g (8.1 oz.)

Handle Unit

Modular unit offers the following options for attaching additional accessories to the camera: 3 cold accessory shoes, sockets for 0.64 cm (1/4") screws (x10) and a socket for 0.95 cm (3/8") screws (x1).

- **Weight:** Approx. 240 g (8.5 oz.)

Mounting Bracket

Modular unit offers the following options for attaching additional accessories to the camera: sockets for 0.64 cm (1/4") screws (x8, some of which are used to attach the bracket to the camera).

- **Weight:** Approx. 80 g (2.8 oz.)

CA-A10 AC Adapter

- **Rated Input:** 100 – 240 V AC, 50/60 Hz, 100 VA (100 V AC) – 124 VA (240 V AC)
- **Rated Output:** 16.7 V DC, 3.0 A
- **Operating Temperature:** 0 – 40 °C (32 – 104 °F)
- **Dimensions (W x H x D):** Approx. 73 x 40 x 139 mm (2.9 x 1.6 x 5.5 in.)
- **Weight:** 450 g (15.9 oz.)

CG-A10 Battery Charger

- **Rated input:** 100 – 240 V AC, 50/60 Hz, 120 VA (100 V AC) – 144 VA (240 V AC)
- **Rated Output:** 16.7 V DC, 3.0 A (2 charging stations, each 1.5 A)
- **Operating Temperature:** 0 – 40 °C (32 – 104 °F)
- **Dimensions (W x H x D):** 200 x 60 x 120 mm (7.9 x 2.4 x 4.7 in.)
- **Weight:** Approx. 755 g (1.7 lb.)

BP-A30 Battery Pack

- **Battery Type**
Rechargeable lithium ion battery, compatible with Intelligent System
- **Rated Voltage:** 14.4 V DC
- **Operating Temperature:** 0 – 40 °C (32 – 104 °F)
- **Rated Battery Capacity:** 3100 mAh / 45 Wh
- **Dimensions (W x H x D):** 41.5 x 45.1 x 69.7 mm (1.6 x 1.8 x 2.7 in.)
- **Weight:** 225 g (7.9 oz)

Reference Tables

Approximate Recording Time on Recording Media

Primary clips

CFast card capacity → Bit rate ↓	64 GB	128 GB
[410 Mbps Intra-frame]	20 min.	40 min.
[310 Mbps Intra-frame]	25 min.	50 min.
[225 Mbps Intra-frame]	35 min.	75 min.
[210 Mbps Intra-frame]	40 min.	80 min.
[160 Mbps Intra-frame]	50 min.	105 min.
[50 Mbps Long GOP]	165 min.	335 min.

Proxy clips

Bit rate → SD card capacity ↓	[35 Mbps Long GOP]	[24 Mbps Long GOP]
16 GB	60 min.	85 min.
32 GB	120 min.	175 min.

Charging Times

Use the supplied CG-A10 Battery Charger to charge battery packs. The charging times given in the following table are approximate and vary according to charging conditions and initial charge of the battery pack.

BP-A30	BP-A60
170 min.	300 min.

4K RAW video12
 4K workflow23

A

ABB (automatic black balance)52
 Abroad, using the camera209
 Accessories210
 ACES color, ACESproxy1024
 AE shift72
 Air vents61
 Aperture70
 Automatic aperture72
 Push auto iris71
 Assignable buttons131
 Audio output channels169
 Audio peak limiter99
 Audio recording96
 Audio recording level99, 100
 Audio reference signal102
 AUDIO terminal29
 AWB (auto white balance)76

B

Battery pack25, 207, 211
 Bit rate63
 Black balance52
 Browser Remote120

C

Camera settings146
 Canon Log/Canon Log 2 gamma138
 CFast card
 Compatible CFast cards46
 Initializing49
 Inserting/Removing47
 Recording method50
 Switching CFast card slots50, 148
 Check marks (☑)105, 154
 Cinema RAW Development (download)172

Clips

Adding an OK mark/☑ mark105, 154
 Adding/Deleting shot marks105, 158
 Clip name format59
 Copying155
 Deleting156
 Displaying clip information153
 Playback149
 Proxy clips111
 Recording53
 Recovering51
 Color bars102
 Color sampling62
 Color space24, 138
 Condensation209
 Connection to external devices163
 Custom displays145
 Custom functions144
 Custom picture134
 Main settings138
 Other settings139
 Preset settings138

D

Date and time30
 DC IN terminal27
 Developing RAW clips172
 Direct setting mode64
 Double slot recording50
 Drop frame (time code)89
 Dual Pixel Focus Guide79

E

EF lens mount36
 External recorder163, 165
 Eye cup40

F

Fan61

Focus	77
AF speed	82
Continuous AF	82
Face AF	84
Focus assistance functions	78
One-shot AF	80
Frame rate	62
Frame recording mode	116
Free-run (time code)	88

G

Gain	67
GENLOCK/SYNC OUT terminal	92
GPS information	108, 128
Grip unit	43

H

Handle unit	44
HDMI OUT terminal	161, 166
Headphone terminal	101
Hour meter	190

I

Index screens	
Clips, Proxy clips	147
Expand clip	158
Shot marks	157
Initializing recording media	49
INPUT 1/INPUT 2 terminals	96, 98
Interval recording mode	117
Intra-frame (XF-AVC compression)	63
Iris	70
ISO speed	67

J

Joystick	32
Joystick guide	151

K

Key lock	55
----------	----

L

Language	31
----------	----

LCD screen	41
Lens	36
Lens correction (chromatic aberration/peripheral illumination)	37
Lens firmware	38
Light metering mode	73
Lithium button battery	28
Long GOP (XF-AVC compression)	63
LUT (lookup table)	167

M

Magnification	79
Menu settings	181
Message list	203
Metadata	106
MIC terminal	96, 100
Microphone	
Attenuator	100, 101
Built-in (monaural)	101
External	97, 98, 100
Sensitivity	99, 100
Modular units	39
MON. terminal	161, 164
Monitor unit	29
Mounting bracket	44
My Menu	33

N

ND filter	69
Network functions	120, 178
Non-drop frame (time code)	89

O

OK marks (OK)	105, 154
Onscreen displays	55, 150
Onscreen markers	86
On-set color grading	24

P

Peaking	79
Phantom power (microphone)	98

Photos	
Deleting	179
Photo numbering	176
Playback via Wi-Fi (Media Server)	178
Recording and grabbing frames from clips	175
Viewing	177
Playback	
Clips	149
Photos	177
Power supply	25
POWER switch	28
Pre-recording mode	115
R	
Rear panel	59
REC OUT terminal	161, 164
Rec run (time code)	88
Recording	
Clips	53
Photos	175
Simultaneous proxy clip recording	111
Recovering corrupted clips	51
Reference tables (charging and recording times, etc.)	217
Relay recording	50
Remaining battery	27, 197
Remote controller	119
Remote operation	119, 120
REMOTE terminal	119
Resetting all camera settings	190
Resolution (frame size)	62
Reviewing a clip	110
Running mode (time code)	88
S	
Safe area	86
Saving clips to a computer	170
SD card	
Compatible SD cards	46
Initializing	49
Inserting/Removing	48
Shooting frame rate	113
Shot marks	105, 158
Shutter speed	65
Slow & fast motion recording mode	113
Specifications	212
Status screens	191
Synchronization	92
System extension terminal	108, 120
System frequency	62
T	
Tally lamp	190
Terminal covers	45
Thumb rest	43
Time code	88
TIME CODE terminal	93, 95
Tripod	42
Troubleshooting	199
Turning the camera on/off	28
U	
User bit	91
User memo	106
V	
Video configuration	62
Video output configuration	161
Video scopes	103
VIDEO terminal	29
Viewfinder	41
W	
Waveform monitor	103
White balance	74
Wide DR	138
X	
XF Utility for XF-AVC (download)	170
Z	
Zebra pattern	87
Zoom	127

CANON CINEMA EOS LIMITED WARRANTY FOR PRODUCTS PURCHASED IN THE UNITED STATES

The limited warranty set forth below is given by Canon U.S.A., Inc. ('Canon USA') with respect to (a) the Canon Cinema EOS Product, and (b) the accessories for the Canon Cinema EOS Product (if any), packaged with this limited warranty (collectively the "Products")* and purchased in the United States. This limited warranty is only effective upon presentation of your Bill of Sale or other proof of purchase. The Products are warranted to the original end-user purchaser, when delivered in new condition in its original container, under normal use against defective materials or workmanship as follows: Parts: At Canon USA's option, defective parts will be exchanged for new parts or comparable rebuilt parts for a period of ONE YEAR from the date of original purchase. Labor: For a period of ONE YEAR from the date of original purchase, labor will be provided free of charge by Canon USA's factory service centers or designated service facilities located in the United States. When returning Products under this warranty, you must pre-pay the shipping charges, and you must enclose a copy of the Bill of Sale or other proof of purchase with a complete explanation of the problem. During the ONE-YEAR warranty period, repairs will be made and the Products will be return-shipped to you free of charge. For repairs after the warranty period is over, you will be given an estimate of the cost of repair and an opportunity to approve or disapprove of the repair expense before it is incurred. If you approve, repairs will be made and the Products will be returned to you at your risk and expense. If you disapprove, we will return-ship the Products to you at no charge to you to an address within the United States.

This limited warranty only applies if the Products are used in conjunction with compatible computer equipment and compatible software, as to which items Canon USA will have no responsibility. Canon USA shall have no responsibility under this limited warranty for use of the Products in conjunction with incompatible peripheral equipment and/or incompatible software. Non-Canon brand peripheral equipment and software which may be distributed with, or factory loaded on, the Products, are sold 'AS IS' without warranty of any kind by Canon USA, including any implied warranty regarding merchantability or fitness for a particular purpose. The sole warranty with respect to such non-Canon brand items is given by the manufacturer or producer thereof.

* Except for the battery pack packaged with the Products, which carries a separate ninety (90) day limited warranty.

In order to obtain warranty service, please contact the authorized Canon retail dealer from whom you purchased the Products or contact the CANON INFORMATION CENTER AT **855-CINE-EOS** (855-246-3367) or on the internet at pro.usa.canon.com/support. You will be directed to the nearest service facility for your Products.

This Limited Warranty covers all defects encountered in normal use of the Products and does not apply in the following cases:

- A. Loss or damage to the Products due to abuse, mishandling, accident, improper maintenance, use of non-Canon accessories or failure to follow operating, maintenance or environmental instructions prescribed in Canon USA's user's manual;
- B. If the Products are defective as a result of leaking batteries, sand, dirt or water damage;
- C. If defects or damages are caused by the use of parts or supplies (other than those sold by Canon USA) that cause damage to the Products or that cause abnormally frequent service calls or service problems;
- D. If defects or damages are caused by service other than Canon USA's factory service centers or authorized service facilities;
- E. Any internal modification to product hardware or firmware;
- F. Any applicable fee for Maintenance of the Products;
- G. If the Product has had its serial number or dating altered or removed.

This Limited Warranty does not apply to Products purchased outside the United States. This Limited Warranty does not apply to accessories or consumables not originally packaged with the Product. Please retain this warranty card and your Bill of Sale as a permanent record of your purchase. This card ensures that you are contacted promptly should there be a safety inspection, modification or Product recall under applicable laws or regulations.

NO IMPLIED WARRANTY, INCLUDING MERCHANTABILITY AND FITNESS FOR A PARTICULAR PURPOSE APPLIES TO THE PRODUCTS AFTER THE APPLICABLE PERIOD OF EXPRESS WARRANTY OR GUARANTY (EXCEPT AS MENTIONED ABOVE) GIVEN BY ANY PERSON, FIRM OR CORPORATION WITH RESPECT TO THE PRODUCTS SHALL BIND CANON USA (SOME STATES DO NOT ALLOW LIMITATIONS ON HOW LONG AN IMPLIED WARRANTY LASTS, SO THE ABOVE LIMITATION OR EXCLUSION MAY NOT APPLY TO YOU). CANON USA SHALL NOT BE LIABLE FOR LOSS OF REVENUES OR PROFITS, EXPENSE FOR SUBSTITUTE PRODUCTS OR SERVICE, STORAGE CHARGES, LOSS OR CORRUPTION OF DATA, INCLUDING WITHOUT LIMITATION, LOSS OR CORRUPTION OF DATA STORED ON THE PRODUCTS' HARD DRIVE, OR ANY OTHER SPECIAL, INCIDENTAL OR CONSEQUENTIAL DAMAGES CAUSED BY THE USE, MISUSE OR INABILITY TO USE THE PRODUCTS, REGARDLESS OF THE LEGAL THEORY ON WHICH THE CLAIM IS BASED, AND EVEN IF CANON USA HAS BEEN ADVISED OF THE POSSIBILITY OF SUCH DAMAGES. NOR SHALL RECOVERY OF ANY KIND AGAINST CANON USA BE GREATER THAN THE PURCHASE PRICE OF THE PRODUCTS SOLD BY CANON USA AND CAUSING THE ALLEGED DAMAGE. WITHOUT LIMITING THE FOREGOING, YOU ASSUME ALL RISK AND LIABILITY FOR LOSS, DAMAGE OR INJURY TO YOU AND YOUR PROPERTY AND TO OTHERS AND THEIR PROPERTY ARISING OUT OF USE, MISUSE OR INABILITY TO USE THE PRODUCTS NOT CAUSED DIRECTLY BY THE NEGLIGENCE OF CANON USA (SOME STATES DO NOT ALLOW THE EXCLUSION OR LIMITATION OF INCIDENTAL OR CONSEQUENTIAL DAMAGES, SO THE ABOVE LIMITATION MAY NOT APPLY TO YOU). THIS LIMITED WARRANTY SHALL NOT EXTEND TO ANYONE OTHER THAN THE ORIGINAL PURCHASER OF THE PRODUCTS OR THE PERSON FOR WHOM IT WAS PURCHASED AS A GIFT.

This warranty gives you specific legal rights, and you may also have other rights which vary from state to state.

CANON CINEMA EOS LIMITED WARRANTY FOR PRODUCTS PURCHASED IN CANADA

The limited warranty set forth below is given by Canon Canada Inc. ('Canon Canada') with respect to (a) the Canon Cinema EOS product, and (b) the accessories for the Canon Cinema EOS Product (if any), packaged with this limited warranty (collectively the "Products") and purchased in Canada. This limited warranty is only effective upon presentation of your Bill of Sale or other proof of purchase. The Products are warranted to the original end-user purchaser, when delivered in new condition in its original container, under normal use against defective materials or workmanship as follows: Parts: At Canon Canada's option, defective parts will be exchanged for new parts or comparable rebuilt parts for a period of ONE YEAR from the date of original purchase. Labor: For a period of ONE YEAR from the date of original purchase, labor will be provided free of charge by Canon Canada's factory service center or designated service facilities located in Canada. When returning Products under this warranty, you must pre-pay the shipping charges, and you must enclose a copy of the Bill of Sale or other proof of purchase with a complete explanation of the problem. During the ONE-YEAR warranty period, repairs will be made and the Products will be return-shipped to you free of charge. For repairs after the warranty period is over, you will be given an estimate of the cost of repair and an opportunity to approve or disapprove of the repair expense before it is incurred. If you approve, repairs will be made and the Products will be returned to you at your risk and expense. If you disapprove, we will return-ship the Products to you at no charge to you to an address within Canada.

This limited warranty only applies if the Products are used in conjunction with compatible computer equipment and compatible software, as to which items Canon Canada will have no responsibility. Canon Canada shall have no responsibility under this limited warranty for use of the Products in conjunction with incompatible peripheral equipment and/or incompatible software. Non-Canon brand peripheral equipment and software which may be distributed with, or factory loaded on, the Products, are sold 'AS IS' without warranty of any kind by Canon Canada, including any implied warranty or condition regarding merchantability or fitness for a particular purpose. The sole warranty with respect to such non-Canon brand items is given by the manufacturer or producer thereof.

* Except for the battery pack packaged with the Products, which carries a separate ninety (90) day limited warranty.

In order to obtain warranty service, please contact the authorized Canon retail dealer from whom you purchased the Products or contact the CANON PROFESSIONAL SERVICE CENTRE 1-800-667-2666 or on the internet at www.canon.ca/pro. You will be directed to the nearest service facility for your Products.

This Limited Warranty covers all defects encountered in normal use of the Products and does not apply in the following cases:

- A. Loss or damage to the Products due to abuse, mishandling, accident, improper maintenance, use of non-Canon accessories or failure to follow operating, maintenance or environmental instructions prescribed in Canon Canada's user's manual;
- B. If the Products are defective as a result of leaking batteries, sand, dirt or water damage;
- C. If defects or damages are caused by the use of parts or supplies (other than those sold by Canon Canada) that cause damage to the Products or that cause abnormally frequent service calls or service problems;
- D. If defects or damages are caused by service other than Canon Canada's factory service centers or authorized service facilities;
- E. Any internal modification to product hardware or firmware;
- F. Any applicable fee for Maintenance of the Products;
- G. If the Product has had its serial number or dating altered or removed.

This Limited Warranty does not apply to Products purchased outside Canada. This Limited Warranty does not apply to accessories or consumables not originally packaged with the Product. Please retain this warranty card and your Bill of Sale as a permanent record of your purchase. This card ensures that you are contacted promptly should there be a safety inspection, modification or Product recall under applicable laws or regulations.

NO IMPLIED WARRANTY OR CONDITION, INCLUDING MERCHANTABILITY AND FITNESS FOR A PARTICULAR PURPOSE APPLIES TO THE PRODUCTS AFTER THE APPLICABLE PERIOD OF EXPRESS WARRANTY OR GUARANTY (EXCEPT AS MENTIONED ABOVE) GIVEN BY ANY PERSON, FIRM OR CORPORATION WITH RESPECT TO THE PRODUCTS SHALL BIND CANON CANADA (SOME PROVINCES DO NOT ALLOW LIMITATIONS ON HOW LONG AN IMPLIED WARRANTY OR CONDITION LASTS, SO THE ABOVE LIMITATION OR EXCLUSION MAY NOT APPLY TO YOU). CANON CANADA SHALL NOT BE LIABLE FOR LOSS OF REVENUES OR PROFITS, EXPENSE FOR SUBSTITUTE PRODUCTS OR SERVICE, STORAGE CHARGES, LOSS OR CORRUPTION OF DATA, INCLUDING WITHOUT LIMITATION, LOSS OR CORRUPTION OF DATA STORED ON THE PRODUCTS' HARD DRIVE, OR ANY OTHER SPECIAL, INCIDENTAL OR CONSEQUENTIAL DAMAGES CAUSED BY THE USE, MISUSE OR INABILITY TO USE THE PRODUCTS, REGARDLESS OF THE LEGAL THEORY ON WHICH THE CLAIM IS BASED, AND EVEN IF CANON CANADA HAS BEEN ADVISED OF THE POSSIBILITY OF SUCH DAMAGES. NOR SHALL RECOVERY OF ANY KIND AGAINST CANON CANADA BE GREATER THAN THE PURCHASE PRICE OF THE PRODUCTS SOLD BY CANON CANADA AND CAUSING THE ALLEGED DAMAGE. WITHOUT LIMITING THE FOREGOING, YOU ASSUME ALL RISK AND LIABILITY FOR LOSS, DAMAGE OR INJURY TO YOU AND YOUR PROPERTY AND TO OTHERS AND THEIR PROPERTY ARISING OUT OF USE, MISUSE OR INABILITY TO USE THE PRODUCTS NOT CAUSED DIRECTLY BY THE NEGLIGENCE OF CANON CANADA (SOME PROVINCES DO NOT ALLOW THE EXCLUSION OR LIMITATION OF INCIDENTAL OR CONSEQUENTIAL DAMAGES, SO THE ABOVE LIMITATION MAY NOT APPLY TO YOU). THIS LIMITED WARRANTY SHALL NOT EXTEND TO ANYONE OTHER THAN THE ORIGINAL PURCHASER OF THE PRODUCTS OR THE PERSON FOR WHOM IT WAS PURCHASED AS A GIFT.

This warranty gives you specific legal rights, and you may also have other rights which vary from province to province.



Canon Inc. 30-2, Shimomaruko 3-chome, Ohta-ku, Tokyo 146-8501, Japan
Canon Europa N.V. Bovenkerkerweg 59, 1185 XB Amstelveen, The Netherlands <http://www.canon-europe.com>

ASIA and HONG KONG, S.A.R.

Canon Hongkong Company Ltd
19/F, The Metropolis Tower, 10 Metropolis Drive,
Hungohm, Kowloon, Hong Kong
☎ +852 3191 2333, 📠 +852 2428 3963

AUSTRALIA <http://www.canon.com.au>

Canon Australia Pty Ltd
☎ 13-13-83 (within Australia only)
☎ (61) 02-9805-2555

CANADA <http://www.canon.ca/pro>

CANON CANADA INC.
❖ Professional Product Support /
Soutien des produits professionnels
☎ (800) 667-2666

CENTRO Y SURAMÉRICA <http://www.cla.canon.com>

CANON LATIN AMERICA, INC.

MÉXICO <http://www.canon.com.mx>

CANON MEXICANA, S DE RL DE CV
☎ 52 (55) 5249-4905

NEW ZEALAND <http://www.canon.co.nz>

Canon New Zealand Ltd
☎ 0800-222-666 (within New Zealand only)
☎ (64) 09-489-0300

SINGAPORE

Canon Singapore Pte. Ltd
1 HarbourFront Avenue, #04-01 Keppel Bay Tower,
Singapore 098632
☎ (65) 6799 8888, 📠 (65) 6799 8882

UNITED KINGDOM

Canon UK Ltd
CCI Service Centre, Unit 130, Centennial Park,
Borehamwood, Hertfordshire, WD6 3SE
☎ 0844-369-0100

USA <http://pro.usa.canon.com>

CANON U.S.A., INC.
<http://pro.usa.canon.com/support>
☎ (855) CINE-EOS (855-246-3367)
(USA only)

Visit your local Canon Web site to download the latest version of this Instruction Manual.