

SK 5212

Instructions for use

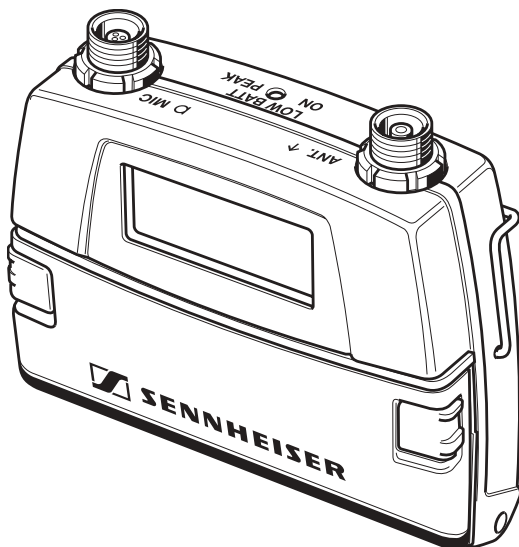

Contents

Safety instructions	3
Delivery includes	3
The SK 521 2 bodypack transmitter	4
The operating controls	5
Indications and displays	6
The LC display panel	6
Preparing the transmitter for use	8
Inserting and changing the battery	8
Connecting the microphone	9
Connecting the antenna	9
Attaching the transmitter to clothing	10
Using the transmitter	10
Switching the transmitter on/off	10
Doing a frequency check	11
The operating menu	12
The buttons	12
The automatic lock mode (autolock function)	13
Working with the operating menu	15
Overview of the operating menu	19
Adjustment tips for the operating menu	21
Selecting a channel – CHAN	21
Selecting the frequencies to be stored in the channel bank “VAR” – TUNE	21
Entering a name – NAME	23
Adjusting the microphone sensitivity – ATTEN	24
Adjusting the bass roll-off frequency – LOWCUT	24
Selecting the standard display – VIEW	24
Loading the factory pre-set default settings – RESET	25
Activating/deactivating the automatic lock mode – LOCK	25
Adjusting the output power – POWER	26
Exiting the operating menu – EXIT	26
Maintenance and care	26
If problems occur... ..	27
Error checklist	27
Information on the compander system	28

Accessories	28
Specifications	29
Pin assignment of microphone socket	30
Audio sensitivity	30
Manufacturer declarations	31
Warranty regulations	31
CE Declaration of Conformity	31
Batteries	31
WEEE Declaration	31

Thank you for choosing Sennheiser!

We have designed this product to give you reliable operation over many years. Over half a century of accumulated expertise in the design and manufacture of high-quality electro-acoustic equipment have made Sennheiser a world-leading company in this field.

Please take a few moments to read these instructions carefully, as we want you to enjoy your new Sennheiser products quickly and to the fullest.

Safety instructions

- Please read these instructions carefully and completely before using the unit.
- Make these instructions easily accessible to all users at all times. Always include these instructions when passing the unit on to third parties.
- Never open electronic units! If units are opened by customers in breach of this instruction, the warranty becomes null and void.
- Water entering the housing of the unit can cause a short-circuit and damage the electronics. Protect the unit from damp and wet. Only use a slightly damp cloth to clean the unit.

Intended use of the unit

Intended use includes

- having read these instructions especially the chapter “Safety instructions”.
- using the unit within the operating conditions as described in these instructions.

Improper use of the unit

Improper use is when you use the unit other than described in these instructions or when you use the unit under operating conditions different from those described in these instructions.

Delivery includes

- 1 SK 5212 bodypack transmitter
- 1 battery
- 1 antenna
- 1 belt clip
- 1 instructions for use

The SK 5212 bodypack transmitter

The SK 5212 is a professional Mikroport bodypack transmitter that is easy to use and is easily adaptable to a wide variety of applications.

The SK 5212 bodypack transmitter has the following features:

- Extremely compact diecast metal housing
- Very rugged casing
- Special protection against the ingress of moisture
- Backlit LC display
- Menu-assisted operation
- Specially suitable for multi-channel applications
- 36 MHz switching bandwidth
- Transmission frequencies tunable in steps of 5 kHz
- 50 mW output power, adjustable to 10 mW
- Constant output power until the battery is completely discharged
- Audio sensitivity adjustable in steps of 1dB, sensitivity range of 70 dB
- HiDyn *plus*TM noise reduction system
- Signal-to-noise ratio > 110 dB(A)
- Switchable low-cut filter
- Battery status display, battery status also transmitted to the receiver
- Reliable, easy-to-use clip attachment

The channel bank system

The transmitter has two channel banks. The channels of the channel bank "FIX" (fixed bank) have been factory pre-set to customer-specific transmission frequencies. These frequencies cannot be changed.

The channel bank "VAR" (variable bank) allows you to freely select and store frequencies.

Suitable receivers

- EM 1046 system
- EM 3532, EM 3031, EM 3032
- EK 3041

The operating controls

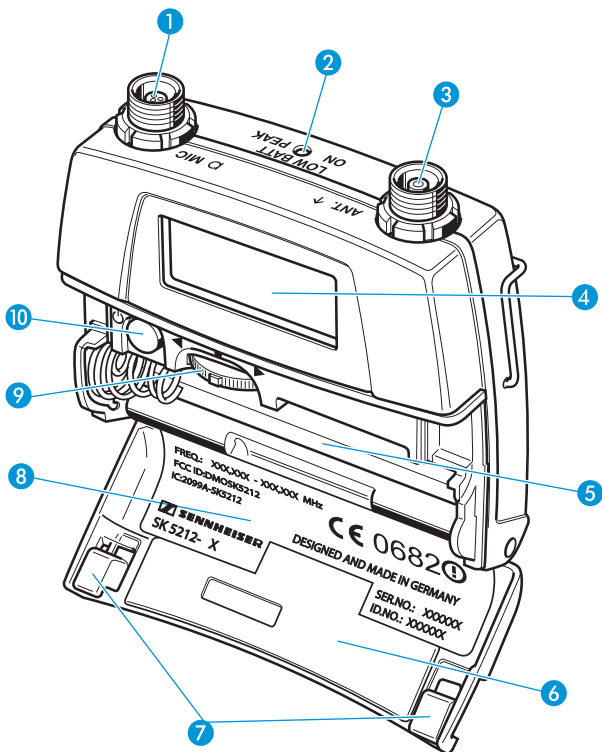

- 1 Microphone input
- 2 Red LED for operation and battery status indication (ON/LOW BAT/PEAK)
- 3 Antenna socket
- 4 LC display, backlit
- 5 Battery compartment
- 6 Battery compartment cover
- 7 Battery compartment catches
- 8 Type plate
- 9 Multi-function switch with three switch positions:
▼ (DOWN), ▲ (UP) and SET
- 10 ON/OFF button

Indications and displays

The LC display panel

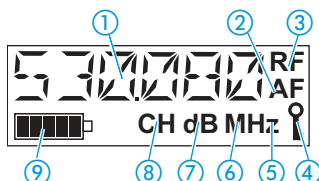

- ① Alphanumeric display
- ② Level display for audio signal "AF"
- ③ "RF" – appears when an RF signal is transmitted
- ④ Lock mode icon (lock mode is activated)
- ⑤ "Hz" – appears when the low-cut frequency is displayed
- ⑥ "MHz" – appears when the transmission frequency is displayed
- ⑦ "dB" – appears when the microphone sensitivity is displayed
- ⑧ "CH" – appears when the channel number is displayed
- ⑨ Battery status display

Display backlighting

When the lock mode is deactivated, the display remains backlit for approx. 20 seconds after pressing a button.

The LED display

The red LED ② provides information on the operating state of the transmitter.

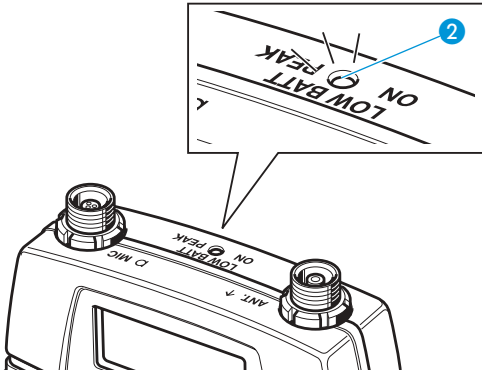

Red LED lights up normally: The transmitter is switched on and the capacity of the battery is sufficient (ON).

Red LED is flashing: The battery is going flat (LOW BATT)!

Red LED lights up brightly: The transmitter is fully modulated (PEAK).

Preparing the transmitter for use

Inserting and changing the battery

For powering the transmitter, use a 1.5 V AA size alkaline-manganese battery.

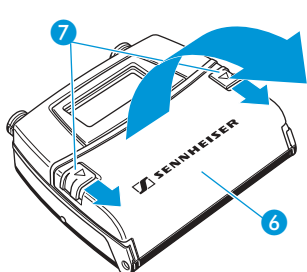

▶ Open the battery compartment by pushing the two catches **7** in the direction of the arrows and open the cover **6**.

▶ Insert the battery as shown in the diagram on the left. Please observe correct polarity when inserting the battery.

▶ Close the battery compartment.

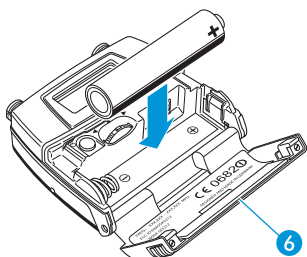

Connecting the microphone

The transmitter is designed for use with Sennheiser lavalier microphones and headmics (-4 versions). The power supply of these microphones is via the microphone input **1** of the transmitter.

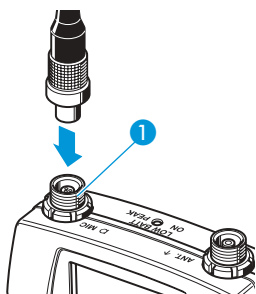

- ▶ Connect the microphone to the microphone input **1** of the transmitter.
- ▶ Screw down the coupling ring.

Connecting the antenna

The transmitter is supplied with a plug-on antenna.

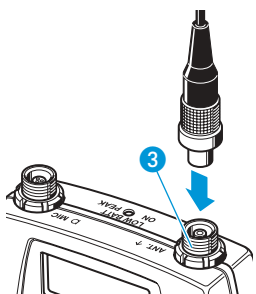

- ▶ Connect the antenna to the antenna socket **3** of the transmitter.
- ▶ Screw down the coupling ring.

Attaching the transmitter to clothing

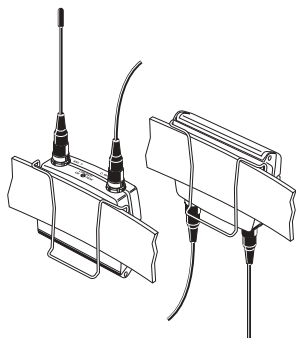

The transmitter is attached to clothing (e.g. belt, waistband) with the supplied belt clip.

The clip is detachable so that you can also attach the transmitter with the antenna pointing downwards. To do so, withdraw the clip from its fixing points and attach it the other way round.

Using the transmitter

Switching the transmitter on/off

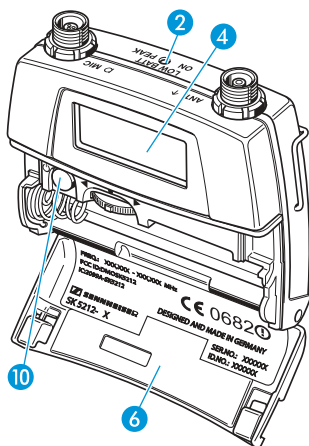

- ▶ Open the battery compartment.
- ▶ To switch the transmitter on, briefly press the **ON/OFF** button **10**. The red LED **2** lights up normally and the standard display is shown on the LC display panel **4**; after a short pause, "RF" appears on the LC display panel.

Note:

- Remove the battery when the transmitter will not be used for extended periods of time.

- The transmitter can only be switched off when the lock mode is deactivated (see “The automatic lock mode (autolock function)” on page 13).



- ▶ To switch the transmitter off, press the ON/OFF button 10 until “OFF” appears on the LC display panel 4. The red LED 2 and the LC display panel go off.

Note:

- When in the setting mode of the operating menu, the ON/OFF button 10 will cancel your entry (ESC function).

Doing a frequency check

The transmitter has a frequency check mode that prevents the transmitter transmitting on an unwanted frequency after switch-on.

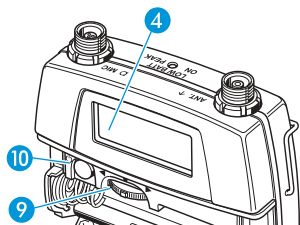

- ▶ When switching on the transmitter, keep the ON/OFF button 10 pressed. The current frequency is displayed on the LC display panel 4 without the transmitter actually transmitting.
- ▶ If the displayed frequency is the correct one, release the ON/OFF button 10. After five seconds, “RF” 3 appears on the LC display panel and the transmitter is transmitting.



To change the transmission frequency, proceed as follows:

- ▶ Release the ON/OFF button 10.
- ▶ Immediately (i.e. within five seconds) press the multi-function switch 9 (switch position •SET) twice.
- ▶ You are now in the setting mode of the “CHAN” or “TUNE” menu where you can change the transmission frequency (see “Adjustment tips for the operating menu” on page 21).

The operating menu

The buttons

Button	Mode	Function
ON/OFF button	Switched off	<ul style="list-style-type: none">• Briefly pressing the button: Switches the transmitter on• Keeping the button pressed: Does a frequency check
	Display mode	<ul style="list-style-type: none">• Briefly pressing the button (with activated autolock function): Immediately activates the lock mode• Briefly pressing the button (with activated lock mode): Calls up the lock mode for deactivation• Pressing the button for 3 sec. (with deactivated lock mode): Switches the transmitter off
	Selection mode	Cancel the entry and returns to the display mode
	Setting mode	Cancel the entry and returns with the last setting stored to the last parameter displayed in the display mode
•SET	Display mode	<ul style="list-style-type: none">• With deactivated lock mode: Changes to the selection mode• With activated lock mode: Calls up the lock mode for deactivation
	Selection mode	Changes to the setting mode of the selected menu
	Setting mode	Stores the setting and returns to the selection mode ("STORED" is displayed)

Button	Mode	Function
▲ (UP)/ ▼ (DOWN)	Display mode	Changes to the previous parameter (▲) or changes to the next parameter (▼)
	Selection mode	Changes to the previous menu (▲) or changes to the next menu (▼)
	Setting mode	Increases (▲) or reduces (▼) the setting of the selected menu

The automatic lock mode (autolock function)

The transmitter has an automatic lock mode (autolock function) that can be activated via the “LOCK” menu (see “Activating/deactivating the automatic lock mode – LOCK” on page 25). When the autolock function is activated, the lock mode is automatically activated 10 seconds after pressing the last button.



Prior to this, the lock mode icon ④ flashes several times on the LC display panel ④, indicating that the lock mode is being activated and, at the same time, the display backlighting goes off.

Note:

The autolock function can be deactivated permanently (see page 25) or temporarily (see page 14).

Deactivating the autolock function temporarily

To make changes to the settings via the operating menu, you can temporarily deactivate the lock mode.

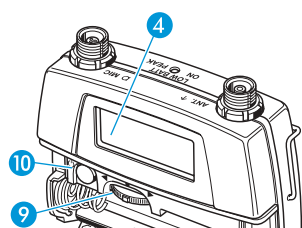

▶ Press the ON/OFF button **10** or the multi-function switch **9** (switch position •SET). "LOCK" appears on the LC display panel **4**.

▶ Slide the multi-function switch **9** to the position ▲ (UP) or ▼ (DOWN).

"UNLOCK" appears on the LC display panel **4**.

▶ Press the multi-function switch **9** (switch position •SET). You can now change the settings.



After you have exited the operating menu, the lock mode is automatically activated after 10 seconds. You can activate the lock mode immediately by briefly pressing the ON/OFF button **10**.

Working with the operating menu

The operating menu has three modes:

- Display mode
In display mode, you can display the current menu settings one after the other – even when the lock mode is activated.
- Selection mode
In selection mode, you can select the menu whose setting you want to change. To change to the selection mode, the lock mode must be deactivated.
- Setting mode
In setting mode, you can change the setting of the selected menu.

By way of example of the “LOWCUT” menu, this section describes how to use the operating menu.

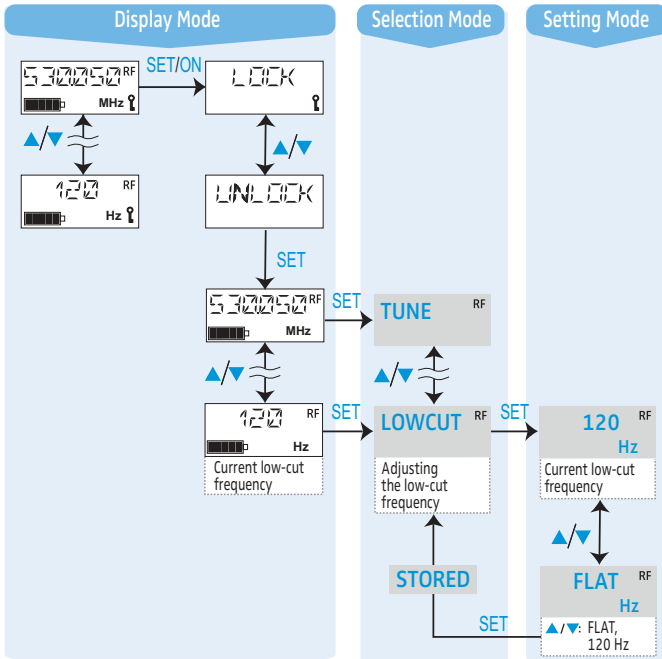

After switch-on

After switch-on, the standard display is shown on the LC display panel ④. Depending on the setting, the transmission frequency, the channel number or the name of the transmitter is displayed.

Displaying the menu settings in display mode

In display mode, and with the lock mode activated, you can display the current menu settings one after the other (see “Overview of the operating menu” on page 19). After a few seconds, the display returns to the standard display.



- ▶ Slide the multi-function switch ⑨ to the position ▲ (UP) or ▼ (DOWN) to display the menu settings. If you slide the multi-function switch repeatedly to the same position, all menu settings are displayed one after the other.

Changing to the selection mode

To change from display mode to selection mode, you have to deactivate the lock mode

- ▶ Deactivate the lock mode as described in the chapter “Deactivating the autolock function temporarily” on page 14. You can now select the menu whose settings you want to adjust.
- ▶ Press the multi-function switch ⑨ (switch position •SET) to change to the menu that was displayed in display mode.

Selecting a menu



- ▶ Slide the multi-function switch ⑨ to the position ▲ (UP) or ▼ (DOWN).
- ▶ Press the multi-function switch ⑨ (switch position •SET). The name of the selected menu starts flashing.

The following menus are available:

Menu	Function of the menu
CHAN	Selecting a channel
TUNE	Setting transmission frequencies for the channel bank "VAR" (variable bank)
NAME	Entering a name
ATTEN	Adjusting the microphone sensitivity
LOWCUT	Adjusting the bass roll-off frequency
VIEW	Selecting the standard display
RESET	Loading the factory pre-set default settings
POWER	Adjusting the output power
LOCK	Activating/deactivating the autolock function
EXIT	Exiting the operating menu and returning to the standard display

Changing to the setting mode of a selected menu



- ▶ Press the multi-function switch 9 (switch position •SET) to change to the setting mode of the selected menu. The current setting that can be adjusted flashes on the LC display panel 4.

Adjusting a setting

Use the multi-function switch 9 to adjust the setting of the selected menu. By briefly sliding the multi-function switch 9 to the position ▲ (UP) or ▼ (DOWN), the display jumps either forwards or backwards to the next setting.

In the "ATTEN", "CHAN", "TUNE" and "NAME" menu and when slid to the position ▲ (UP) or ▼ (DOWN), the multi-function switch 9 features a "fast search" function, i.e. the display cycles continuously. In the "TUNE" menu, the cycling of the display is continuously accelerated. The "fast search" function allows you to get fast and easily to your desired setting.

Storing a setting



- ▶ Press the multi-function switch 9 (switch position •SET) to permanently store a setting. "STORED" appears on the display panel, indicating that the setting has been stored. The display then returns to the top menu level.

With most menus, new settings become effective immediately without having to be stored. An exception are the "TUNE" and "CHAN" menus. With these menus, new settings only become effective after they have been stored ("STORED" appears on the LC display panel 4, indicating that the setting has been stored).

Exiting the operating menu

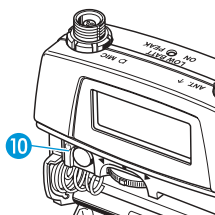

- ▶ Select the "EXIT" menu to exit the operating menu and to return to the standard display. When in the operating menu, pressing the ON/OFF button 10 will cancel your entry (ESC function) and return you to the standard display with the last stored settings.

Overview of the operating menu

Deactivate the lock mode before adjusting the settings (see “Deactivating the autolock function temporarily” on page 14). Pressing the **ON/OFF** button **10** will cancel your entry (ESC function) and return you to the display mode.

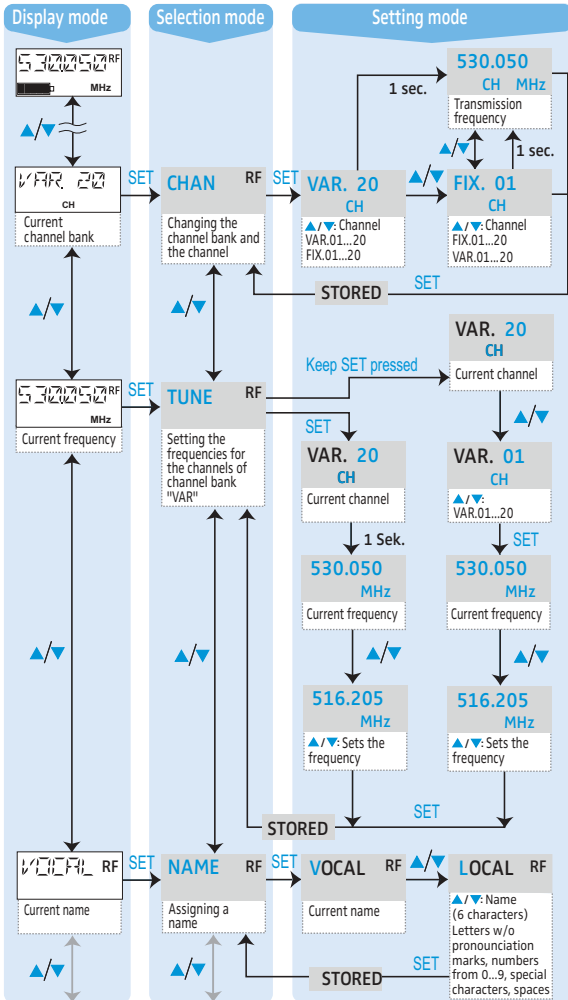

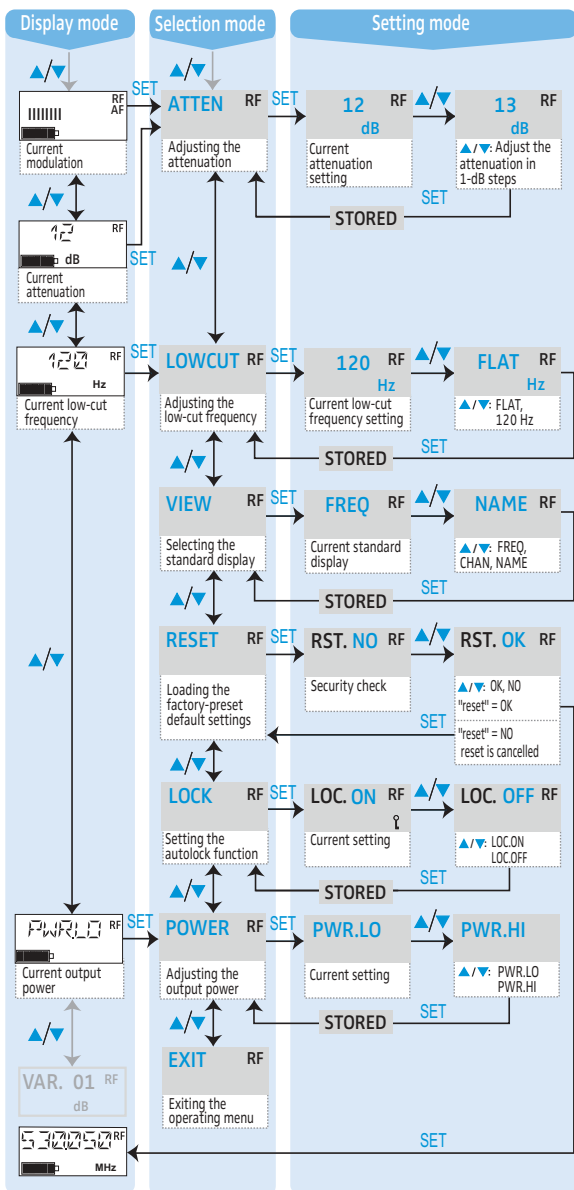

Adjustment tips for the operating menu

Selecting a channel – CHAN

Via the “CHAN” menu, you can switch between the channels in the channel banks “FIX” and “VAR”. The transmitter is not transmitting while this adjustment is being made.

When changing to the setting mode of the “CHAN” menu, the current channel number appears on the display. After approx. 1 second, the currently assigned transmission frequency is displayed.

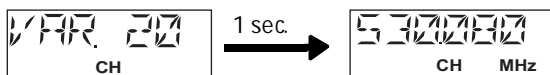

- ▶ To select a different channel, slide the multi-function switch 9 to the position ▲ (UP) or ▼ (DOWN). The new channel number appears on the display panel for approx. 1 second and then the currently assigned transmission frequency is displayed.

Only after the new setting has been stored (“STORED” has appeared on the LC display panel) does the transmitter operate on the transmission frequency of the new channel.

Note:

The frequencies in the channel bank “FIX” can only be changed by a Sennheiser Service Partner. If you require a special frequency set in this bank, please contact your local Sennheiser Service Partner.

Selecting the frequencies to be stored in the channel bank “VAR” – TUNE

Via the “TUNE” menu, you can freely select the frequencies to be stored in the channel bank “VAR” (variable bank). The transmitter is not transmitting while this adjustment is being made.

Note:

When you have selected the channel bank “FIX” and then select the “TUNE” menu, the transmitter automatically switches to channel 01 of the channel bank “VAR” and “VAR” briefly appears on the LC display panel 4.

The frequencies are tunable in 5-kHz steps within a switching bandwidth of 36 MHz max.

Note:

When operating a multi-channel system, make sure to only use inter-modulation-free frequencies.

There are two options for setting the frequencies:

- You can set a new frequency for the selected channel:



- ▶ In the selection mode of the “TUNE” menu, press the multi-function switch 9 (switch position •SET). The current channel number appears on the display and then the currently assigned frequency is displayed.

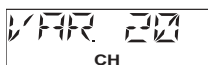

- ▶ Change the frequency by sliding the multi-function switch 9 to the position ▲ (UP) or ▼ (DOWN).

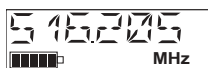

- ▶ Store your setting.

- You can change to a different channel and set a new frequency for the new channel:



- ▶ Press the multi-function switch 9 (switch position •SET) for a longer time. The current channel flashes on the display.

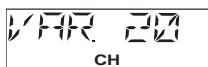

- ▶ Select a new channel by sliding the multi-function switch 7 to the position ▲ (UP) or ▼ (DOWN).

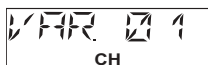

- ▶ Confirm your selection by pressing the multi-function switch (switch position •SET).



- ▶ The current frequency of the selected channel is displayed.
Change the frequency by sliding the multi-function switch 9 to the position ▲ (UP) or ▼ (DOWN).
- ▶ Store your setting.

Entering a name – NAME

Via the “NAME” menu, you can enter a freely selectable name for the transmitter. This name can be displayed on the standard display and can consist of up to six characters such as:

- letters (without pronunciation marks),
- numbers from 0 to 9,
- special characters and spaces.

After you have changed to the setting mode of the “NAME” menu, the first segment starts flashing on the LC display panel 4.



- ▶ Slide the multi-function switch 9 to the position ▲ (UP) or ▼ (DOWN) to select a character. (By sliding the switch only once, the display jumps either forwards or backwards to the next character. If you keep the switch slid, the display starts cycling continuously.)
- ▶ Press the multi-function switch 9 (switch position •SET) to change to the next segment.
- ▶ Have you entered the name completely? Press the multi-function switch 9 (switch position •SET) to store your setting. “STORED” appears on the LC display panel 4.

Adjusting the microphone sensitivity – **ATTEN**

Via the “**ATTEN**” menu, you can adjust the transmitter’s sensitivity.

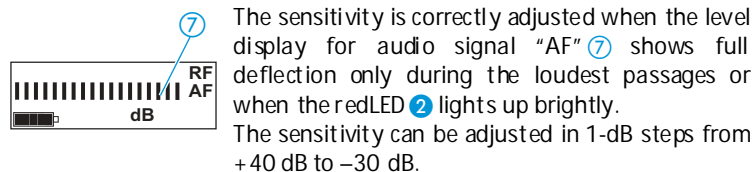

Note:

- The bargraph has a resolution of approx. 3 dB per segment with a display range of 45 dB.

Adjusting the bass roll-off frequency – **LOWCUT**

To reduce unwanted low-frequency noise such as wind and handling noise, you can activate a low-cut filter. The low-cut frequency is 120Hz.

If you do not want to reduce low-frequency signal portions, select the setting “FLAT”.

Selecting the standard display – **VIEW**

Via the “**VIEW**” menu, you can select one of the following standard displays:

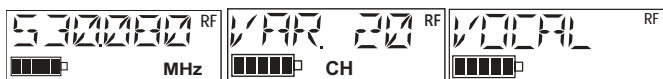

Transmission
frequency “**FREQ**”

Channel
“**CHAN**”

Name
“**NAME**”

The selected standard display is shown

- after switch-on,
- after the menu settings have been displayed for 10 seconds in display mode.

Loading the factory pre-set default settings – RESET

Via the “RESET” menu, you can load the factory pre-set default settings. After the reset, the standard display is shown on the LC display panel.

Low-cut frequency	flat
Microphone sensitivity	0 dB
Name	SK5212
Standard display	frequency
Autolock function	deactivated
Channel	FIX 01
Output power	high

Frequencies in the channel bank “VAR” are reset.

Activating/deactivating the automatic lock mode – LOCK

The transmitter has an autolock function (automatic lock mode) that can be activated or deactivated via the “LOCK” menu. When the autolock function is activated, the lock mode is automatically activated 10 seconds after pressing the last button. The lock mode protects the transmitter from accidental programming.

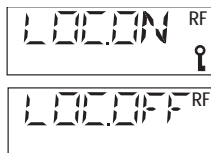

- ▶ In the selection mode of the “LOCK” menu, press the multi-function switch 9 (switch position •SET).
The current setting of the autolock function is displayed.
- ▶ Change the setting by sliding the multi-function switch 9 to the position ▲ (UP) or ▼ (DOWN).
Select “LOC.ON” to activate the autolock function or select “LOC.OFF” to deactivate the autolock function.
- ▶ Store your setting by pressing the multi-function switch 9 (switch position •SET).

Adjusting the output power – POWER

Licensing regulations may require a limitation of the output power to 10 mW. The transmitter therefore features a switchable output power. With reduced output power, the operating time increases.

Exiting the operating menu – EXIT

Via the “EXIT” menu, you can exit the operating menu and return to the standard display.

When in the operating menu, briefly pressing the ON/OFF button  will cancel your entry (ESC function) and return you to the standard display without saving any changes.

Maintenance and care

CAUTION!

Water can damage the electronics of the unit!

Water entering the housing of the unit can cause a short-circuit and damage the electronics.



- ▶ Only use a slightly damp cloth to clean the unit. Do not use any cleansing agents or solvents.
-

If problems occur...

Error checklist

Problem	Possible cause	Possible solution
No operation indication	Battery is flat or inserted incorrectly	Replace the battery or check if it is inserted correctly
Transmitter cannot be switched off/ Settings cannot be changed	Lock mode is activated	Deactivate the lock mode (see "Deactivating the autolock function temporarily" on page 14)
Receiver: No RF signal	Transmitter and receiver are not on the same channel	Set transmitter and receiver to the same channel
	Transmitter is out of range	Check the squelch threshold setting on the receiver or reduce the distance between receiving antenna and transmitter
Audio signal has a high level of background noise	Transmitter's sensitivity is set too high	See "Adjusting the microphone sensitivity – ATTEN" on page 24
	Receiver's output level is set too low	Increase the line output level
Audio signal is distorted	Transmitter's sensitivity is set too low	See "Adjusting the microphone sensitivity – ATTEN" on page 24
	Receiver's output level is set too high	Reduce the line output level

If problems occur that are not listed in the above table or if the problems cannot be solved with the proposed solutions, please contact your local Sennheiser agent for assistance.

Tips for optimum reception

- Transmission range depends to a large extent on location and on the selected output power. There should be a "free line of sight" between transmitting and receiving antennas.
- To avoid overmodulating the receiver, observe a minimum distance of 5 m between transmitting and receiving antennas.

Tips for multi-channel operation

- When operating a multi-channel system, make sure to only use intermodulation-free frequencies.

Information on the compander system

This unit is equipped with HiDyn *plus*[™], the Sennheiser noise reduction system that reduces RF interference. HiDyn *plus*[™] offers extreme operational reliability and ensures highest transmission quality.

Accessories

MKE 2 Gold	Lavalier microphone, omni-directional
MKE 2 Platinum	Lavalier microphone, omni-directional
ME 102	Modular mini-microphone system, omni-directional
ME 104	Modular mini-microphone system, cardioid
ME 105	Modular mini-microphone system, super-cardioid
HSP 2	Headmic, omni-directional
HSP 4	Headmic, cardioid

Specifications

Modulation	wideband FM
Frequency range	450–960 MHz
Switching bandwidth	36 MHz
Transmission frequencies	channel bank “FIX” with customer-specific frequencies; channel bank “VAR” with 20 freely selectable frequencies (frequencies tunable in steps of 5 kHz)
RF output power	switchable, typ.: 50 mW (PWR.HI) 10 mW (PWR.LO)
Frequency stability	±10 ppm
Spurious emission	< 4 nW
Nominal/peak deviation	±40 kHz/±56 kHz
Signal-to-noise ratio	110 dB(A) _{rms}
THD	< 0.3 % at nominal deviation, 1 kHz
AF frequency response	60–20,000 Hz
Noise reduction system	Sennheiser HiDyn <i>plus</i> SM
Input sensitivity at nominal deviation, 1 kHz	–40 dB _u = 7.75 mV, adjustable in steps of 1 dB, range: 70 dB
Low-cut frequency (–3 dB)	adjustable (flat, 120 Hz)
Power supply	1 AA size battery (1.5 V)
Power consumption (without LC display illumination)	approx. 160 mA at 1.2 V (PWR.LO) approx. 250 mA at 1.2 V (PWR.HI)
Operating time	approx. 11 hrs (PWR.LO) approx. 5.5 hrs (PWR.HI)
Temperature range	–10 °C to +55 °C
Connections	AF: 3-pin special microphone socket RF: coax socket
Dimensions [mm]	approx. 53 x 60 x 17
Weight	approx. 120 g incl. battery
Type approval	USA: FCC-Part 74.861 FCC ID: DMOSK5212 Canada: RSS-123, IC: 2099A-SK5212 EU: requirements of R&TTE EN 50392 ETSI EN 300 422-1/-2, class II ETSI EN 301 489-1/-9 CE 0682!

Pin assignment of microphone socket

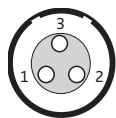

AF socket

Pin 1: +5.2 V for external special microphones

Pin 2: AF and 5.2 V AB-powering; 8.2 k Ω internal resistance, optimized for Sennheiser pre-polarized condenser microphones

Pin 3 and thread: ground

Audio sensitivity

The transmitter's audio sensitivity can be adjusted over a range of 70 dB (+40 dB to -30 dB) in steps of 1 dB. The diagram below shows the sensitivity range of the SK 5212 in comparison to the earlier product generations SK 50 and SK 5012.

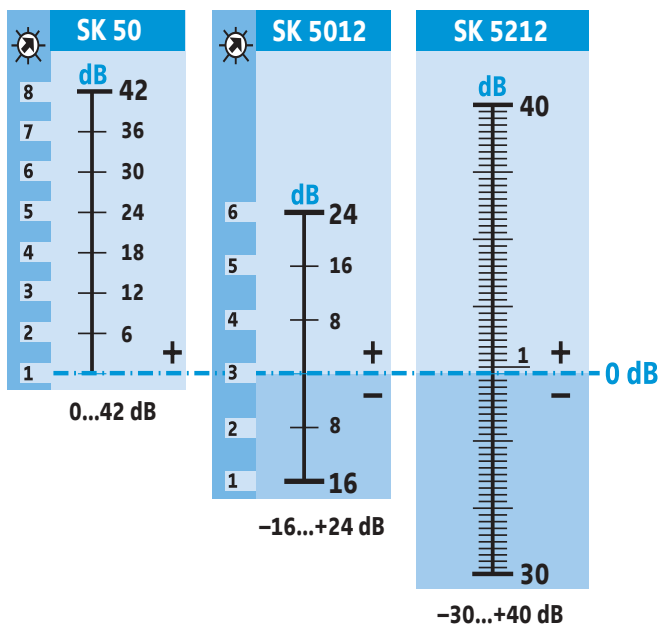

Switch position

Manufacturer declarations

Warranty regulations

The guarantee period for this Sennheiser product is 24 months from the date of purchase. Excluded are accessory items and disposable batteries that are delivered with the product; due to their characteristics these products have a shorter service life that is principally dependent on the individual frequency of use.

The guarantee period starts from the date of original purchase. For this reason, we recommend that the sales receipt be retained as proof of purchase. Without this proof (which is checked by the responsible Sennheiser service partner) you will not be reimbursed for any repairs that are carried out.

Depending on our choice, guarantee service comprises, free of charge, the removal of material and manufacturing defects through repair or replacement of either individual parts or the entire device. Inappropriate usage (e.g. operating faults, mechanical damages, incorrect operating voltage), wear and tear, force majeure and defects which were known at the time of purchase are excluded from guarantee claims. The guarantee is void if the product is manipulated by non-authorized persons or repair stations.

In the case of a claim under the terms of this guarantee, send the device, including accessories and sales receipt, to the responsible service partner. To minimise the risk of transport damage, we recommend that the original packaging is used. Your legal rights against the seller, resulting from the contract of sale, are not affected by this guarantee.

The guarantee can be claimed in all countries outside the U.S. provided that no national law limits our terms of guarantee.

CE Declaration of Conformity

CE 0682 ⓘ

This equipment is in compliance with the essential requirements and other relevant provisions of Directives 1999/5/EC, 89/336/EC or 73/23/EC. The declaration is available on the internet site at www.sennheiser.com.

Before putting the device into operation, please observe the respective country-specific regulations!

Batteries



The supplied battery can be recycled. Please dispose of it as special waste or return it to your specialist dealer. In order to protect the environment, only dispose of exhausted batteries.

WEEE Declaration



Your Sennheiser product was developed and manufactured with high quality materials and components which can be recycled and/or reused. This symbol indicates that electrical and electronic equipment must be disposed of separately from normal waste at the end of its operational lifetime.

Please dispose of this product by bringing it to your local collection point or recycling centre for such equipment. This will help to protect the environment in which we all live.



Sennheiser electronic GmbH & Co. KG
30900 Wedemark, Germany
Phone +49 (5130) 600 0
Fax +49 (5130) 600 300
www.sennheiser.com